

Connection of CES-AR to Pilz PDP67

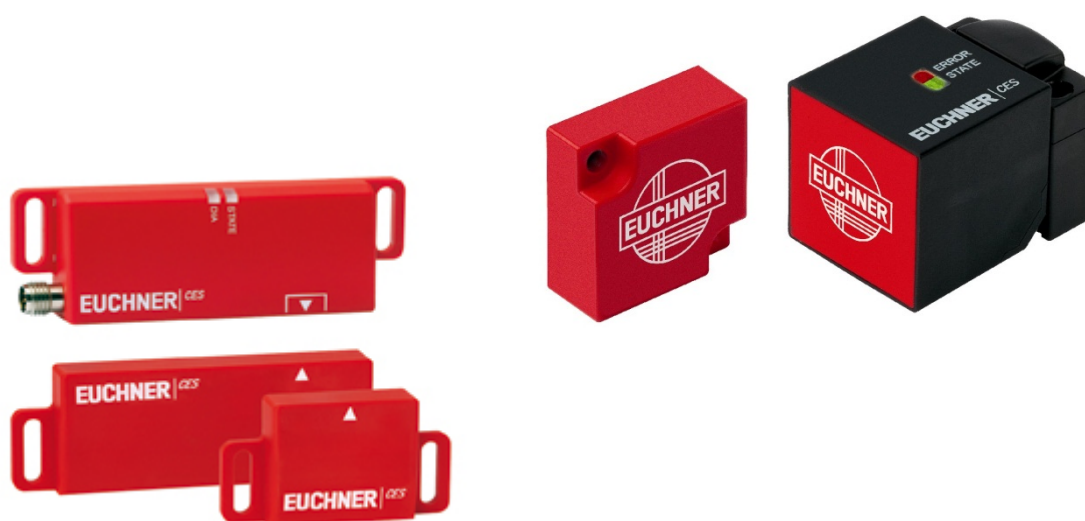

Content

Interlocking device according to EN ISO 14119	2
Components/modules used	2
EUCHNER	2
Other	2
Functional description	3
General	3
Connections	3
Safety assessment	3
Principle circuit diagram	4
Parameter assignment of the Decentralised periphery	5
Program	5
Inputs i0 and i1	5
Reset	6
General	7
Delay Time	8
Output parameters	9
Important note – please observe carefully!	10

Subject to technical modifications, no responsibility is accepted for the accuracy of this information. © EUCHNER 2015

Interlocking device according to EN ISO 14119

Safety function Interlocking device according to EN ISO 14119

Reliability figures according to EN ISO 13849 PL d

Components/modules used

EUCHNER

Description	Order no./ item designation
Safety switches with transponder technology	098582 / CES-AR-C01-EH-SA
	098941 / CES-AR-C01-AH-SA
	098942 / CES-AR-C01-CH-SA
	105745 / CES-AR-CR2-CH-SA-105745
	105746 / CES-AR-CR2-AH-SA-105746
	105747 / CES-AR-CL2-CH-SA-105747
	105748 / CES-AR-CL2-AH-SA-105748
	105750 / CES-AR-CR2-CH-SG-105750
	105751 / CES-AR-CR2-AH-SG-105751
	105752 / CES-AR-CL2-CH-SG-105752
	105753 / CES-AR-CL2-AH-SG-105753
	110939 / CES-AR-CR2-CH-SA-110939
	110940 / CES-AR-CL2-CH-SA-110940
	112711 / CES-AR-CR2-CH-SG-112711
	112712 / CES-AR-CL2-CH-SG-112712
	112928 / CES-AR-CR2-CH-SA-112928
	112929 / CES-AR-CL2-CH-SA-112929
	115792 / CES-AR-CR2-CH-SA-115792
	115793 / CES-AR-CL2-CH-SA-115793

Tip: More information and downloads about the above mentioned EUCHNER products can be found at www.EUCHNER.de. Simply enter the order number into the search field.

Other

Description	Items
Base Unit	PNOZ m1p v5.8
	PNOZ m0p
Expansion module	PNOZ ml2p - 773602
Decentralised periphery	PDP F 8DI ION HP – 773601
	PDP F 8DI ION – 773600

Functional description

General

The CES-AR is part of an interlocking device in accordance with EN ISO 14119. The two safe outputs of the CES are connected to a PDP67 Decentralised periphery.

Connections

Designation	Function	Use in this example
UB	Power supply	Connected to 24 V DC. Note: It has to be configured with PNOZ Multi Configurator.
OA, OB	Safety outputs. HIGH when the safeguarding device is closed and the actuator is in operating distance	Switch-off of at least one of the outputs must lead to shut-down of the machine or installation via the connected control system. Important: The actual shutdown of the energy which is causing a hazard in a machine is not shown in the example and must be supplemented.
IA, IB	Inputs for series connection of AR devices from EUCHNER.	Connected to 24 V DC. Note: It has to be configured with PNOZ Multi Configurator.
OUT	Monitoring output. HIGH when outputs OA and OB are switched on (safety guard closed).	Function is not used.
RST	Input for resetting the switch.	Function is not used.

Safety assessment

The CES-AR features complete monitoring for faults in the safety-relevant parts and in the connected cables (clock pulses at outputs OA and OB). With the device's own pulsing, switch-off or non-connection of the clock signals from the control system's safe inputs does not lead to a reduction in the PL. The example achieves PL d in accordance with EN ISO 13849-1 for the interlocking of a guard.

Tip: If PL e is needed a CES-AP can be used.

Please obtain that through the time delay the switching off time of the CES will be delayed.

Principle circuit diagram

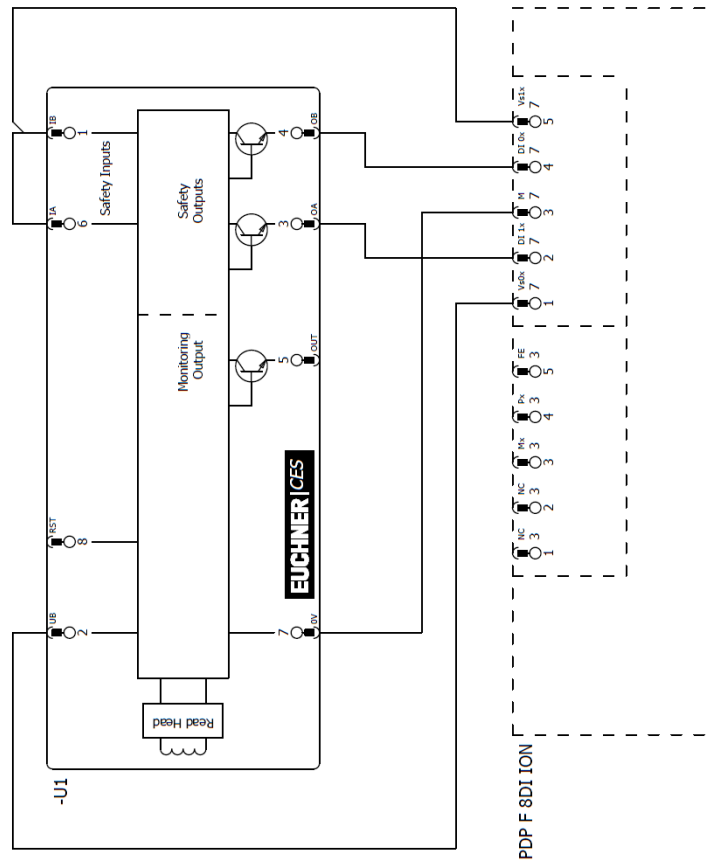

Figure 1

Parameter assignment of the Decentralised periphery

Program

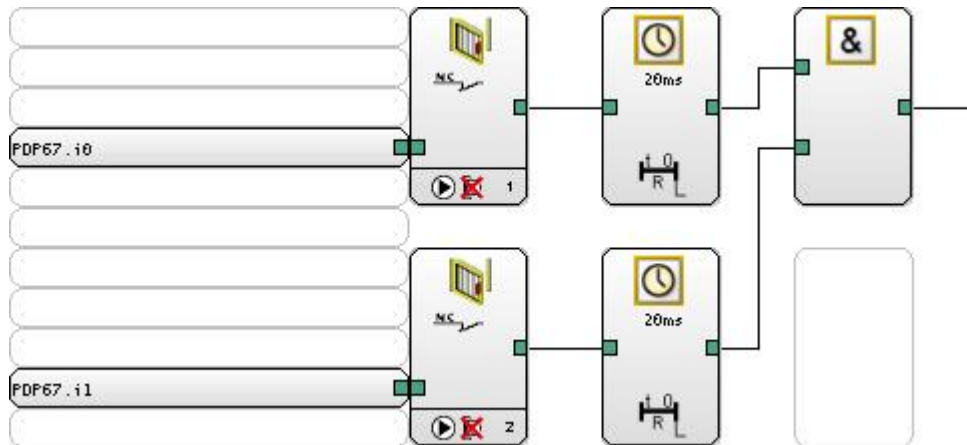

Figure 2

Inputs i0 and i1

Parameter	Value
Switch Type	Type 1
Detection of shorts between contacts in the input circuit	Off
I/O	i0

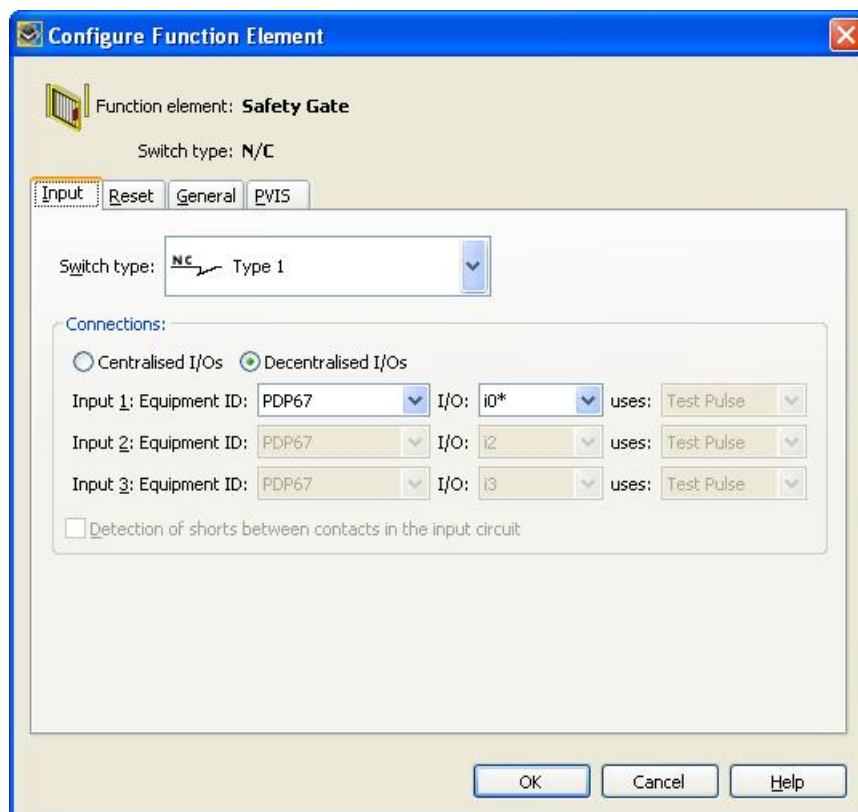

Figure 3

Reset

Parameter	Value
Reset Type	Automatic Reset
Start-up test	Off



Figure 4

General

Parameter	Value
Change Default Value	On
Period	0ms

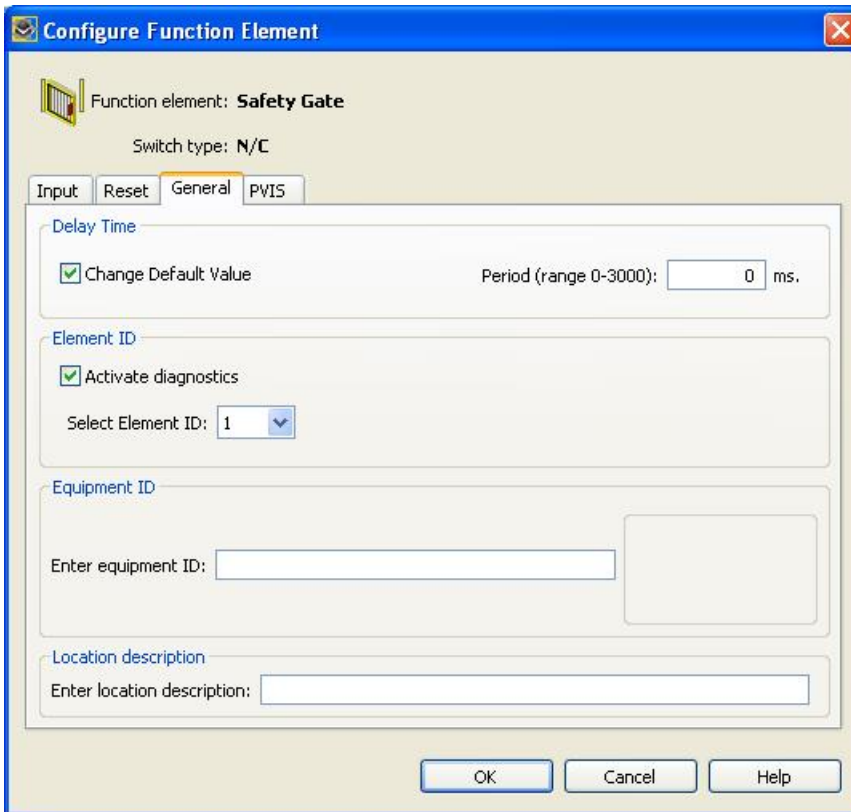

Figure 5

Delay Time

Parameter	Value
Type of element	Delay Time
Delay Time	Switch-off delay
Retriggerable	On
Period	20 ms

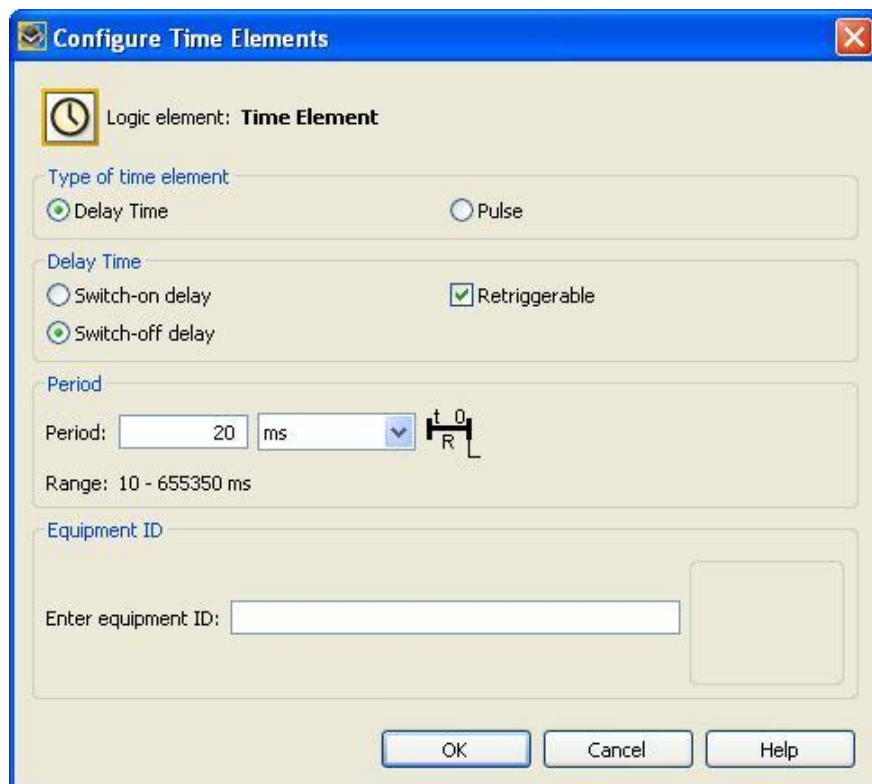

Figure 6

Output parameters

Parameter	Value
Decentralised I/Os (UB, IA, IB)	24 V DC Output

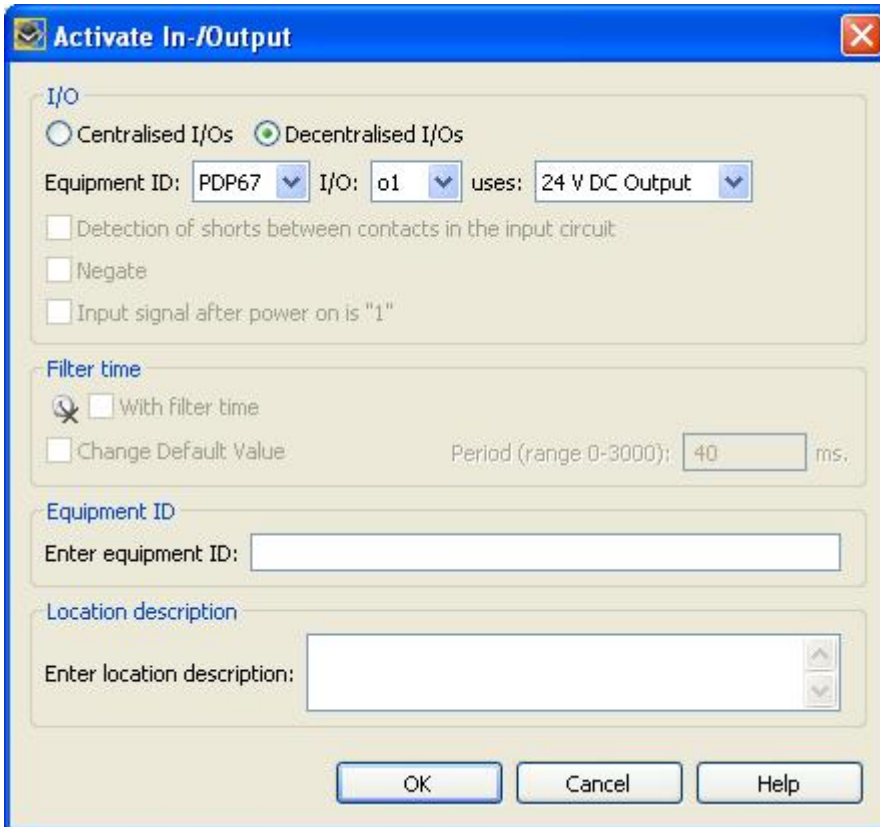

Figure 7

Important note – please observe carefully!

This document is intended for a design engineer who possesses the requisite knowledge in safety engineering and knows the applicable standards, e.g. through training for qualification as a safety engineer. Only with the appropriate qualification is it possible to integrate the introduced example into a complete safety chain.

The example represents only a part of a complete safety chain and does not fulfill any safety function on its own. In order to fulfill a safety function, the energy switch-off function for the hazard location and the software within the safety evaluation must also be considered, for example.

The introduced applications are only examples for solving certain safety tasks for protecting safety guards. The examples cannot be comprehensive due to the application-dependent and individual protection goals within a machine/installation.

If questions pertaining to this example remain open, please contact us directly.

In accordance with Machinery Directive 2006/42/EC, the design engineer of a machine or installation is obligated to perform a risk assessment and take measures to reduce the risk. When doing this, the engineer must comply with the applicable national and international standards. Standards generally represent the current state of the art. Therefore, the design engineer should continuously inform himself about changes in the standards and adapt his considerations to them. Relevant standards include EN ISO 13849 and EN 62061. This application must be regarded only as assistance for the considerations about safety measures.

The design engineer of a machine/installation is obligated to assess the safety technology himself. The examples must not be used for assessment, because only a small excerpt of a complete safety function was considered in terms of safety engineering here.

In order to be able to use the safety switch applications correctly on safety guards, it is indispensable to observe the standards EN ISO 13849-1, EN ISO 14119 and all relevant C-standards for the respective machine type. Under no circumstances does this document replace the engineer's own risk assessment, and it cannot serve as the basis for a fault assessment.

Particularly in case of a fault exclusion, it must be noted that this can be performed only by the design engineer of a machine or installation and requires a reason. A general fault exclusion is not possible. More information about fault exclusion can be found in EN ISO 13849-2.

Changes at products or within assemblies from third-party suppliers used in this example can lead to the function no longer being ensured or the safety assessment having to be adapted. In any event, the information in the operating instructions on the part of EUCHNER, as well as on the part of third-party suppliers, must be taken as the basis before this application is integrated into an overall safety function. If contradictions should arise between the operating instructions and this document, please contact us directly.

Use of brand and company names

All mentioned brand and company names are property of the respective manufacturers. The use is only for clear identification of compatible peripheral devices and environment of operation in combination with our products.