

Connection of serial wired CES-AR to safety relay PNOZ s4.1



Content

Interlocking device according to EN ISO 14119	2
Components/modules used.....	2
EUCHNER	2
Other	2
Functional description	3
General.....	3
Connections	3
Safety assessment	3
Principle circuit diagram.....	4
AR safety switches connected in series	6
Usage of the Reset input	6
Teaching in actuators.....	6
Setting of the operating mode selector switch “mode”	7
Automatic, manual start – without short circuit detection	7
Monitored start rising edge – without short circuit detection	7
Monitored start falling edge – without short circuit detection.....	7
Setting of the Reset for PNOZ s4.1	8
Manual Reset.....	8
Automatic Reset	8
Important note – please observe carefully!.....	9

Interlocking device according to EN ISO 14119

Safety function Interlocking device according to EN ISO 14119

Reliability figures according to EN ISO 13849 Category 4, PL e

Components/modules used

EUCHNER

Description	Order no./ item designation
Safety switches with transponder technology	098582 / CES-AR-C01-EH-SA
	098941 / CES-AR-C01-AH-SA
	098942 / CES-AR-C01-CH-SA
	105745 / CES-AR-CR2-CH-SA-105745
	105746 / CES-AR-CR2-AH-SA-105746
	105747 / CES-AR-CL2-CH-SA-105747
	105748 / CES-AR-CL2-AH-SA-105748
	105750 / CES-AR-CR2-CH-SG-105750
	105751 / CES-AR-CR2-AH-SG-105751
	105752 / CES-AR-CL2-CH-SG-105752
	105753 / CES-AR-CL2-AH-SG-105753
	110939 / CES-AR-CR2-CH-SA-110939
	110940 / CES-AR-CL2-CH-SA-110940
	112711 / CES-AR-CR2-CH-SG-112711
	112712 / CES-AR-CL2-CH-SG-112712
	112928 / CES-AR-CR2-CH-SA-112928
	112929 / CES-AR-CL2-CH-SA-112929
	115792 / CES-AR-CR2-CH-SA-115792
	115793 / CES-AR-CL2-CH-SA-115793

Tip: More information and downloads about the above mentioned EUCHNER products can be found at www.EUCHNER.de. Simply enter the order number into the search field.

Other

Description	Items
EMERGENCY STOP Safety relay	PNOZ s4.1 / 750 124 (V1.0)
	PNOZ s4.1 C / 751 124 (V1.0)

Functional description

General

The CES-AR is part of an interlocking device in accordance with EN ISO 14119. In this example 3 CES-AR are connected in series. The two safe outputs of the last CES-AR are connected to a PNOZ s4.1 safety relay.

Connections

Designation	Function	Use in this example
OA, OB	Safety outputs. HIGH when the safeguarding device is closed and the actuator is in operating distance.	Switch-off of at least one of the outputs leads to a direct switch-off of the safety contacts (13 – 14, 23 – 24, ...) of the safety relay PNOZ s4.1. Important: The actual shutdown of the energy which is causing a hazard in a machine is not shown in the example and must be supplemented.
IA, IB	Inputs for series connection of AR devices from EUCHNER.	U3: connected to 24V DC. U2 and U1: connected to OA and OB of the previous device.
OUT	Monitoring output. HIGH when outputs OA and OB are switched on (safety guard closed and locked).	Function is not used.
RST	Input for resetting the switch	Activated via switch S5. All CES connected in series must be reset simultaneously. Refer to the section "AR safety switches connected in series".

Safety assessment

The CES features complete monitoring for faults in the safety-relevant parts and in the connected cables (clock pulses at outputs OA and OB). The safety relay PNOZ s4.1 achieve up to PL e according to the manufacturer's information (see the device's operating instructions for this purpose). The wiring corresponds to the circuit "light barrier or safety switch with detection of shorts across contacts via ESPE" in the operating instructions of the PNOZ s4.1. Therefore, PL e in accordance with EN ISO 13849-1 can be achieved for position monitoring of a safety guard and for interlocking (preventing the operation of a machine element under certain conditions). Series connection of three CES devices does not reduce the achievable PL.

Important: Switch-off of the energy and any necessary monitoring energy switch-off (feedback loop) of the hazard are not part of this document and must be added in accordance with the risk assessment for the machine. In this example, the safety evaluation unit without feedback loop and without start button is used. Please refer to the operating instructions of the safety evaluation unit for more information.

Principle circuit diagram

In the example Automatic Reset of the PNOZ s4.1 is used

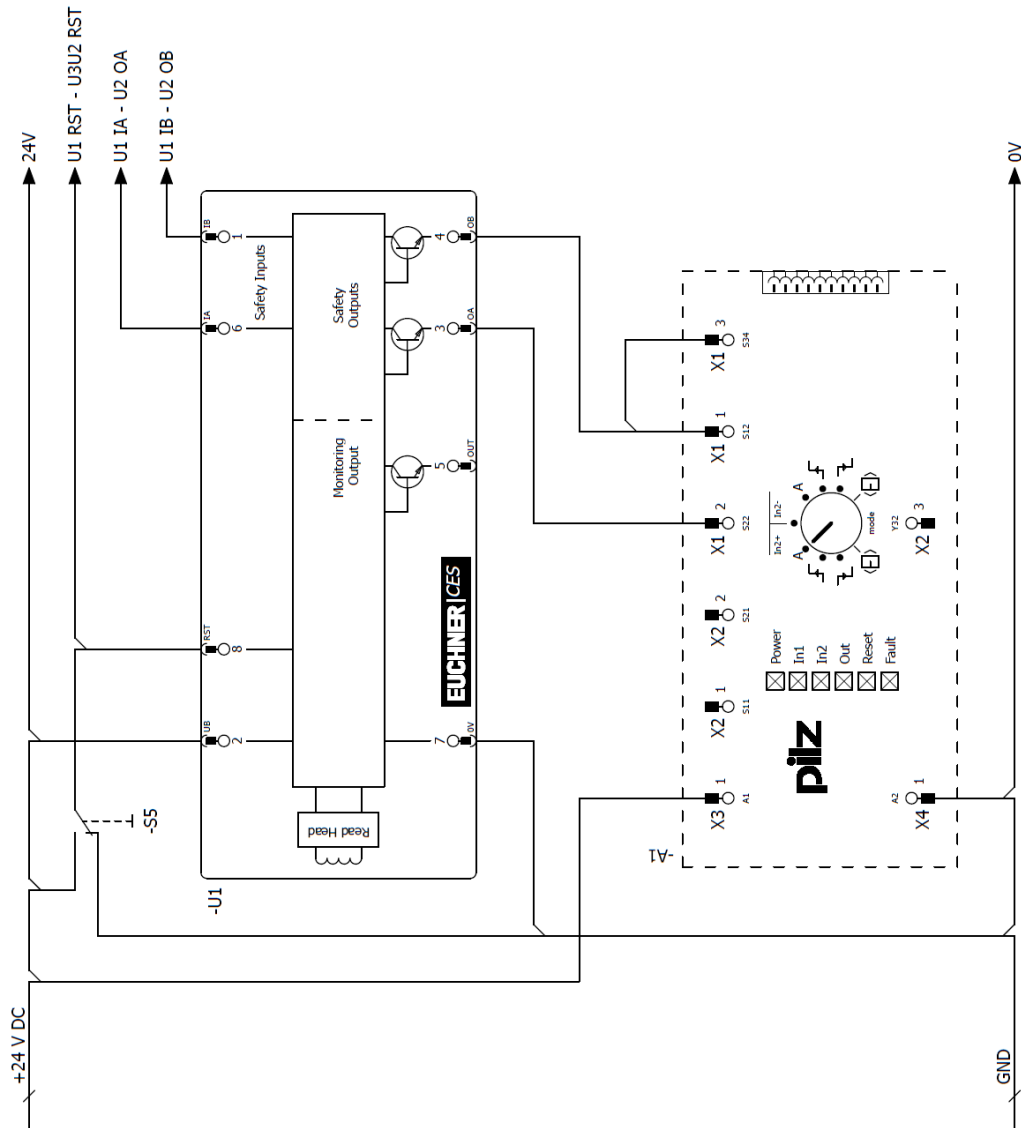

Figure 1

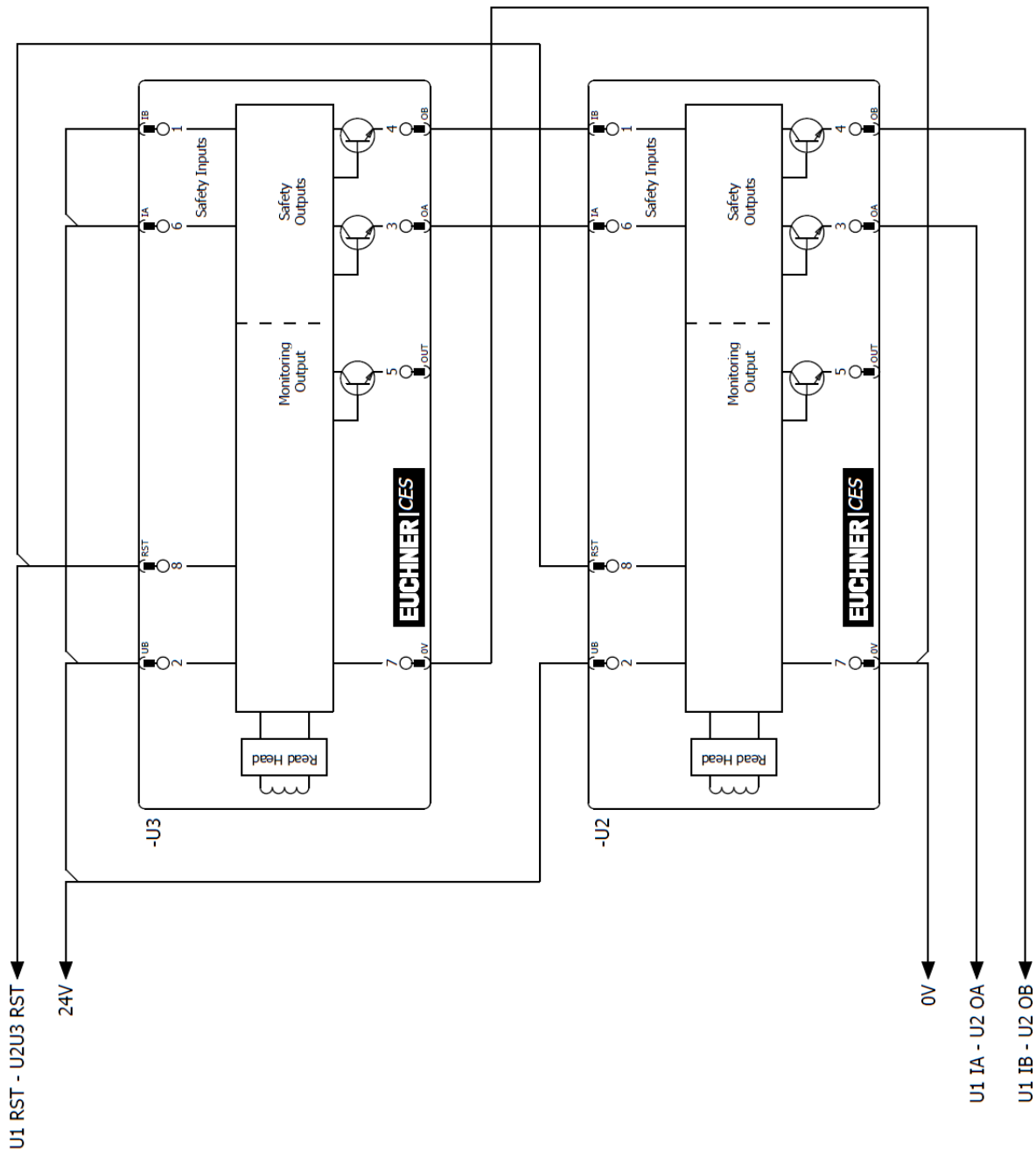

Figure 2

AR safety switches connected in series

Usage of the Reset input

In a series connection the reset must always be connected to all switches. A common signal must be used for all switches in the chain. This can be a changeover switch or the output of a control system. A button is not suitable because Reset must always be connected to GND during operation.

The reset is used to synchronize the switches connected in series. This action is necessary if synchronization is lost due to external effects. This situation may be caused by switching off one of the switches in the series. All switches in the chain must always be reset together, as otherwise the synchronization will fail and as a result the safety outputs will not switch.

Teaching in actuators

It is recommended not to teach-in the actuators in the series circuit, but to teach them in one by one instead.

It is often only possible to teach-in actuators in an installed chain with limitations. Work on the wiring (e.g. during device replacement) should in general be performed in a de-energized state. On certain systems, it is nevertheless necessary to perform this work and subsequent teach-in during ongoing operation.

To make this action possible, the input RST must be connected as shown in Figures 1 and 2.

Proceed as follows:

1. Open the safety door on which the switch or actuator is to be replaced.
2. Mount the new switch or actuator and close all safety doors in the chain.
3. Actuate the reset for at least 3 s (24 V on RST).
4. On the safety switch that is positioned at a new actuator, the green LED flashes at approx. 1 Hz and the actuator is taught-in. This happens for approx. 1 minute - do not switch off during this time and do not actuate reset!
The teach-in operation has ended when the LED on the device is off.
5. Actuate the reset for at least 3 s (24 V on RST).
The system re-starts and then operates normally again.

Setting of the operating mode selector switch “mode”

Only with the following settings does the safety relay PNOZ s4.1 operate correctly with a CES-AR.

Automatic, manual start – without short circuit detection

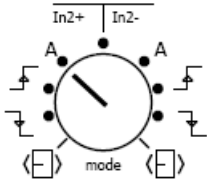
Operating mode selector switch “mode”	Automatic, manual start
Without short circuit detection	

ATTENTION: For an automatic start push-button S2 has to be replaced by a bridge.

Monitored start rising edge – without short circuit detection

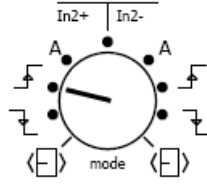
Operating mode selector switch “mode”	Monitored start, rising edge
Without short circuit detection	

Monitored start falling edge – without short circuit detection

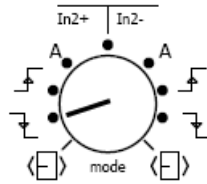
Operating mode selector switch “mode”	Monitored start falling edge
Without short circuit detection	

Setting of the Reset for PNOZ s4.1

Only with the following settings does the safety relay PNOZ s4.1 operate correctly with a CES-AR.

Manual Reset

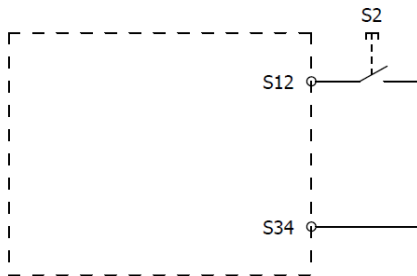

Automatic Reset

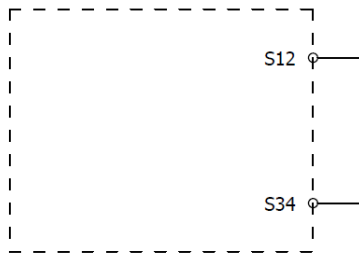

Important note – please observe carefully!

This document is intended for a design engineer who possesses the requisite knowledge in safety engineering and knows the applicable standards, e.g. through training for qualification as a safety engineer. Only with the appropriate qualification is it possible to integrate the introduced example into a complete safety chain.

The example represents only a part of a complete safety chain and does not fulfill any safety function on its own. In order to fulfill a safety function, the energy switch-off function for the hazard location and the software within the safety evaluation must also be considered, for example.

The introduced applications are only examples for solving certain safety tasks for protecting safety guards. The examples cannot be comprehensive due to the application-dependent and individual protection goals within a machine/installation.

If questions pertaining to this example remain open, please contact us directly.

In accordance with Machinery Directive 2006/42/EC, the design engineer of a machine or installation is obligated to perform a risk assessment and take measures to reduce the risk. When doing this, the engineer must comply with the applicable national and international standards. Standards generally represent the current state of the art. Therefore, the design engineer should continuously inform himself about changes in the standards and adapt his considerations to them. Relevant standards include EN ISO 13849 and EN 62061. This application must be regarded only as assistance for the considerations about safety measures.

The design engineer of a machine/installation is obligated to assess the safety technology himself. The examples must not be used for assessment, because only a small excerpt of a complete safety function was considered in terms of safety engineering here.

In order to be able to use the safety switch applications correctly on safety guards, it is indispensable to observe the standards EN ISO 13849-1, EN ISO 14119 and all relevant C-standards for the respective machine type. Under no circumstances does this document replace the engineer's own risk assessment, and it cannot serve as the basis for a fault assessment.

Particularly in case of a fault exclusion, it must be noted that this can be performed only by the design engineer of a machine or installation and requires a reason. A general fault exclusion is not possible. More information about fault exclusion can be found in EN ISO 13849-2.

Changes at products or within assemblies from third-party suppliers used in this example can lead to the function no longer being ensured or the safety assessment having to be adapted. In any event, the information in the operating instructions on the part of EUCHNER, as well as on the part of third-party suppliers, must be taken as the basis before this application is integrated into an overall safety function. If contradictions should arise between the operating instructions and this document, please contact us directly.

Use of brand and company names

All mentioned brand and company names are property of the respective manufacturers. The use is only for clear identification of compatible peripheral devices and environment of operation in combination with our products.