

Electronic-Key-System

Manual

EKS and EKS FSA

with Ethernet TCP/IP interface

Compact V3.X.X

Modular V1.X.X

Order no. 2547185



EKS.

Ethernet



EUCHNER

More than safety.

Table of contents

1	General notes	4
1.1	Use of the manual	4
1.1.1	Explanation of symbols	4
1.1.2	Abbreviations	5
1.2	CE conformity	5
1.3	Approvals	5
1.3.1	UL approval	5
1.3.2	Radio frequency approvals for USA and Canada	6
1.4	Correct use	7
1.5	Obligations on the operating organization	7
2	Safety precautions	8
3	Function	9
3.1	Functional description	9
3.1.1	Common functions of EKS Standard and version EKS <i>FSA</i>	9
3.1.2	Additional functions of the version EKS <i>FSA</i>	10
4	Technical data	11
4.1	Dimension drawing of Electronic-Key adapter compact	11
4.1.1	Version EKS-A-IEX-G01-ST02/03 with Ethernet interface	11
4.1.2	Version EKS-A-IEXA-G01-ST02/03/04 (EKS <i>FSA</i>) with Ethernet interface	11
4.2	Dimension drawing of FHM Electronic-Key adapter modular	12
4.3	Dimension drawing of Ethernet TCP/IP modular interface adapter	12
4.4	Technical data for compact version	13
4.5	Technical data for modular version	14
4.6	Connector assignment	15
4.6.1	Connection socket for Ethernet interface	15
4.6.2	Connection terminal assignment for compact version	15
4.6.3	Connection terminal assignment for modular version	16
4.7	DIP switch settings	18
4.7.1	DIP switch S1	18
4.7.2	DIP switch S2	19
4.7.3	DIP switch S3	19
4.8	Indicator LED of compact version	20
4.9	Indicator LEDs of modular version	20
5	Mounting	21
5.1	Electronic-Key adapter compact	21
5.2	Electronic-Key adapter FHM	21

6	Electrical connection	22
6.1	Ethernet connection	23
6.1.1	Ethernet configuration	23
6.2	Connection of power supply	25
6.3	Connection of functional earth	25
6.4	Connection of the semiconductor switching contacts (for EKS <i>FSA</i> only)	25
7	Setup	26
7.1	Network settings	26
7.1.1	Network settings for a configuration PC with Windows®	26
7.2	Configuring the read/write station via the web interface	29
8	Data transfer via the Ethernet TCP/IP interface	31
8.1	Communication	31
8.2	Basic message structure	31
8.2.1	IP – Internet Protocol	31
8.2.2	TCP – Transport Control Protocol	31
8.3	Commands for writing and reading an Electronic-Key read/write	32
8.3.1	Write process	33
8.3.2	Read process	34
8.3.3	Reading the serial number	35
8.3.4	Read the Electronic-Key status	35
8.4	Command overview	36
8.5	Status numbers	36
9	Exclusion of liability	37
10	Service and repair	37
11	Guarantee	37

1 General notes

1.1 Use of the manual

This manual describes the technical features and the function of the EKS Ethernet TCP/IP read/write stations listed below (also referred to as “devices” for short in the rest of the text).

With the compact version, the Electronic-Key adapter and the evaluation and interface electronics for data transmission are accommodated completely in one housing:

- ▶ Electronic-Key adapter compact EKS-A-IEX-G01-ST02/03 (order no. 100401) with Ethernet TCP/IP interface V3.X.X
- ▶ Electronic-Key adapter compact EKS-A-IEXA-G01-ST02/03/04 (order no. 099265) with Ethernet TCP/IP interface V3.X.X; version *FSA* (For **S**afety **A**pplications)

With the modular version, the Electronic-Key adapter and the interface adapter with the evaluation and interface electronics for data transmission are accommodated in two separate housings:

- ▶ Electronic-Key adapter modular EKS-A-SFH... in combination with modular interface adapter EKS-A-AEX-G18 (order no. 167456) with Ethernet TCP/IP interface V1.X.X
- ▶ Electronic-Key adapter modular EKS-A-SFH... in combination with modular interface adapter EKS-A-AEXA-G18 (order no. 167457) with Ethernet TCP/IP interface V1.X.X; version *FSA* (For **S**afety **A**pplications)



Information!

The modular interface adapters EKS-A-AEX... will only be available in the course of 2023.

1.1.1 Explanation of symbols

The following symbols are used in this manual to identify important instructions and useful information:



Danger!

Identifies an immediate hazard. If not avoided, the consequence will be fatality or very serious injuries.



Warning!

Identifies a possible hazard. If not avoided, the consequence may be fatality or very serious injuries.



Caution!

Identifies a possible hazard. If not avoided, minor injuries or damage may result.



Attention!

Risk of damage to material or machine or degradation of function.



Information!

Important information is provided to the user here.

1.1.2 Abbreviations

The following abbreviations are used in this manual:

- ▶ **DHCP** Dynamic Host Configuration Protocol
- ▶ **DIP** Dual Inline Package
- ▶ **DNS** Domain Name Service
- ▶ **E²PROM** Electrically Erasable Programmable Read-Only Memory
- ▶ **EKS** Electronic-Key-System
- ▶ **EKS FSA** Electronic-Key-System For Safety Applications
- ▶ **FHM** Front Hook Modular
- ▶ **LED** Light Emitting Diode
- ▶ **LSB** Least Significant Bit
- ▶ **MSB** Most Significant Bit
- ▶ **PA** PolyAmide
- ▶ **RD** Receive Data
- ▶ **ROM** Read-Only Memory
- ▶ **TCP/IP** Transmission Control Protocol / Internet Protocol
- ▶ **TD** Transmit Data

1.2 CE conformity

The EKS devices with Ethernet TCP/IP interface correspond to the Radio Equipment Directive (RED) 2014/53/EU and the RoHS Directive 2011/65/EU. The devices comply with the following European standards:

- ▶ EN 55011 Industrial, scientific and medical equipment – Radio-frequency disturbance characteristics – Limits and methods of measurement
- ▶ EN 61000-6-2 Electromagnetic compatibility (EMC) – Part 6-2: Generic standards – Immunity standard for industrial environments
- ▶ EN 50364 Product standard for human exposure to electromagnetic fields from devices operating in the frequency range 0 Hz to 300 GHz, used in Electronic Article Surveillance (EAS), Radio Frequency Identification (RFID) and similar applications
- ▶ EN 300330 V2.1.1 Short Range Devices (SRD); Radio equipment in the frequency range 9 kHz to 25 MHz and inductive loop systems in the frequency range 9 kHz to 30 MHz; Harmonised Standard covering the essential requirements of article 3.2 of Directive 2014/53/EU
- ▶ EN 50581 Technical documentation for the assessment of electrical and electronic products with respect to the restriction of hazardous substances

1.3 Approvals

1.3.1 UL approval

The EKS read/write stations with Ethernet interface are certified in accordance with  (UL file number E240367).

For use and operation as per the  requirements, a power supply with the feature “**for use in class 2 circuits**” must be used.

1.3.2 Radio frequency approvals for USA and Canada

Product description: Electronic-Key-System Compact

FCC ID: 2AJ58-15

IC ID: 22052-15

Product description: Electronic-Key-System Modular

FCC ID: 2AJ58-16

IC ID: 22052-16

FCC/IC-Requirements

This device complies with part 15 of the FCC Rules and with Industry Canada's licence-exempt RSSs. Operation is subject to the following two conditions:

- 1) This device may not cause harmful interference, and
- 2) this device must accept any interference received, including interference that may cause undesired operation.

Changes or modifications not expressly approved by the party responsible for compliance could void the user's authority to operate the equipment.

NOTE: This equipment has been tested and found to comply with the limits for a Class A digital device, pursuant to part 15 of the FCC Rules. These limits are designed to provide reasonable protection against harmful interference when the equipment is operated in a commercial environment. This equipment generates, uses, and can radiate radio frequency energy and, if not installed and used in accordance with the instruction manual, may cause harmful interference to radio communications.

Operation of this equipment in a residential area is likely to cause harmful interference in which case the user will be required to correct the interference at his own expense.

This equipment complies with FCC and ISED radiation exposure limits set forth for an uncontrolled environment. This equipment should be installed and operated with minimum distance of 20 cm between the radiator and your body.

This transmitter must not be co-located or operating in conjunction with any other antenna or transmitter.

Le présent appareil est conforme aux CNR d'Industrie Canada applicables aux appareils radio exempts de licence. L'exploitation est autorisée aux deux conditions suivantes :

- (1) l'appareil ne doit pas produire de brouillage, et
- (2) l'utilisateur de l'appareil doit accepter tout brouillage radioélectrique subi, même si le brouillage est susceptible d'en compromettre le fonctionnement.

Cet équipement est conforme aux limites d'exposition aux rayonnements ISED établies pour un environnement non contrôlé. Cet équipement doit être installé et utilisé avec un minimum de 20 cm de distance entre la source de rayonnement et votre corps.

Ce transmetteur ne doit pas être placé au même endroit ou utilisé simultanément avec un autre transmetteur ou antenne.

1.4 Correct use

As part of a higher-level overall system, the EKS read/write station is used for access control and monitoring on control systems or parts of control systems for machine installations. EKS can be used, for example, as part of an overall system for checking access rights on the selection of the operating mode. However, it is not permitted to derive the operating mode directly from the access rights on the Electronic-Key. If the selection of the operating mode is relevant for safety, this must not be performed by means of the EKS; instead an additional device must be used to select the operating mode.



Information!

The Machinery Directive 2006/42/EC provides information on selection of the operating mode. It is imperative that this information be followed.

When designing machines and using the read/write station, the national and international regulations and standards specific to the application must be observed, e.g.:

- ▶ EN 60204, Safety of machinery – Electrical equipment of machines
- ▶ EN 12100-1, Safety of machinery – Basic concepts, general principles for design – Part 1: Basic terminology, methodology
- ▶ EN 62061, Safety of machinery – Functional safety of safety-related electrical, electronic and programmable electronic control systems
- ▶ EN ISO 13849-1, Safety of machinery – Safety-related parts of control systems – Part 1: General principles for design

Modifications to the electronics of the read/write station and any other changes, especially mechanical modifications and reworking, are not permissible and will result in the loss of the warranty and exclusion of liability.

The read/write station must be employed and used only in accordance with

- ▶ this manual and
- ▶ other documentation referred to in this manual.

The EKS read/write station is not a safety component in the sense of the Machinery Directive.

Without additional precautions the EKS read/write station must not be used to provide a safety function, particularly if failure or malfunction of the device could endanger the safety or health of people in the operating area of a machine.

1.5 Obligations on the operating organization

The manufacturer and the organization operating the higher-level overall system, e.g. a machine installation, are responsible for the observance of national and international safety and accident prevention regulations applicable in the specific case.

2 Safety precautions

**Warning!**

The EKS read/write station is not a safety component in the sense of the Machinery Directive. Without additional precautions the read/write station must not be used to provide a safety function, particularly if failure or malfunction of the device could endanger the safety or health of people in the operating area of a machine. On this topic, pay particular attention to the sections *Correct use* (see chapter 1.4) and *Electrical connection* (see chapter 6).

**Warning!**

Mounting and electrical connection are allowed to be performed only by authorized personnel who are familiar with the applicable regulations on accident prevention and have read and understood this manual.

Furthermore, mounting and electrical connection of the version EKS *FSA* must be performed only by personnel familiar with handling safety components.

**Caution!**

Modifications to the electronics of the read/write station and any other changes, especially mechanical modifications and reworking, are not permissible and will result in the loss of the warranty.

3 Function

3.1 Functional description

3.1.1 Common functions of EKS Standard and version EKS FSA

The EKS is used for access control and monitoring on control systems or parts of control systems for machine installations.

Instead of passwords, coded Electronic-Keys are assigned. In this way unauthorized access to control and visualization systems is prevented to the greatest possible extent.

The EKS uses a non-contact, inductive read/write identification system.

It comprises:

- ▶ Electronic-Key
- ▶ Electronic-Key adapter EKS compact or Electronic-Key adapter FHM with interface adapter EKS modular

The user is responsible for organizing the programming of the application, integration into an overall system and the assignment and use of the freely programmable memory in the Electronic-Key.



Information!

For easier organization and management of your Electronic-Keys and the data they contain, EUCHNER also offers the Electronic-Key-Manager EKM software. To enter data in the EKM software, an Electronic-Key adapter with serial interface or USB interface must be in operation on the PC.

EKS Ethernet TCP/IP devices are read/write systems with electronics for the inductive bidirectional interface to the transponder and interface electronics.

Due to the non-contact transfer of data, the Electronic-Key adapter is designed with a high degree of protection suitable for industry from the access side. The Electronic-Key adapter is fastened from the rear side of the panel in order to exclude unauthorized tampering from the operator side.

The system is connected via the Ethernet TCP/IP interface, which is designed as an RJ45 socket. A separate switch may be required for the Ethernet TCP/IP connection. The device does not have an integrated switch.

Setup and system integration can be implemented straightforwardly and quickly on the read/write station with Ethernet TCP/IP interface.

The current state of the Electronic-Key adapter is displayed using a 3-color LED.

The Electronic-Key is placed on the Electronic-Key adapter for operation. The power supply for the transponder and the data are transferred between the Electronic-Key adapter and the Electronic-Key without using any contacts.



Figure 1: Cut-away illustration of an Electronic-Key adapter with Electronic-Key in the compact version

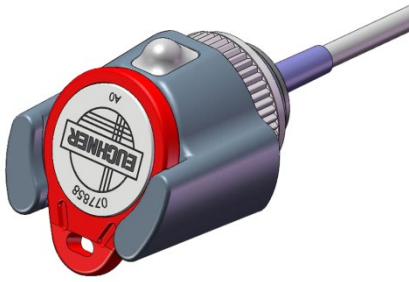

Figure 2: Illustration of an Electronic-Key adapter with Electronic-Key in the modular version

The Electronic-Keys are tag shaped. The complete transponder with memory chip and antenna is integrated into the Electronic-Key. The transponder does not have a battery.

The data carrier in the Electronic-Key is equipped with a combined memory:

- ▶ 116 bytes E²PROM (programmable) plus 8 bytes ROM (serial number)

The programmable memory of 116 bytes is organized in 4-byte blocks. This means a multiple of 4-byte-sized blocks must always be written.

3.1.2 Additional functions of the version EKS FSA

The version EKS FSA has additional switching contacts (semiconductor relay) that are switched off as long as there is no Electronic-Key in the Electronic-Key adapter or if the Electronic-Key cannot be read.

- ▶ Device in compact version: switching contacts LA1/LA2 and optionally LB1/LB2
- ▶ Modular version of the device: only switching contact LA1/LA2

The switching contacts are electrically isolated from the device electronics and from each other. Either AC or DC can be switched.

Each of the contacts is operated with diversity by a dedicated processor that opens the contacts on removal of the Electronic-Key (see figure Block diagram EKS FSA).

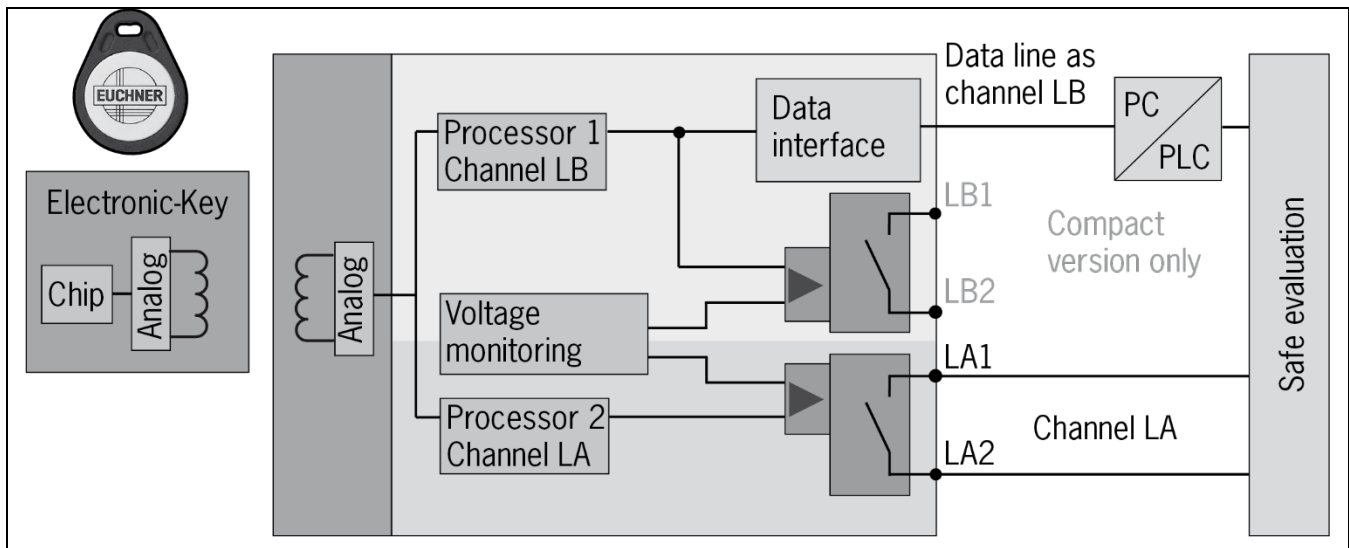

Figure 3: Block diagram EKS FSA

Due to separate evaluation of channel LA and channel LB, the EKS FSA device can be used in conjunction with a safe evaluation device in safety-related applications. Integrated voltage monitoring switches off the switching contacts LA and LB if the power supply is outside the permitted tolerance (see chapters 4.4 and 4.5).



Information!

The switching contacts FSA close when the Electronic-Key is in place, irrespective of the data allocation in the memory.

4 Technical data

4.1 Dimension drawing of Electronic-Key adapter compact

For installation in a control panel, you must provide a cut-out measuring 33 mm x 68 mm according to DIN IEC 61554.

4.1.1 Version EKS-A-IEX-G01-ST02/03 with Ethernet interface

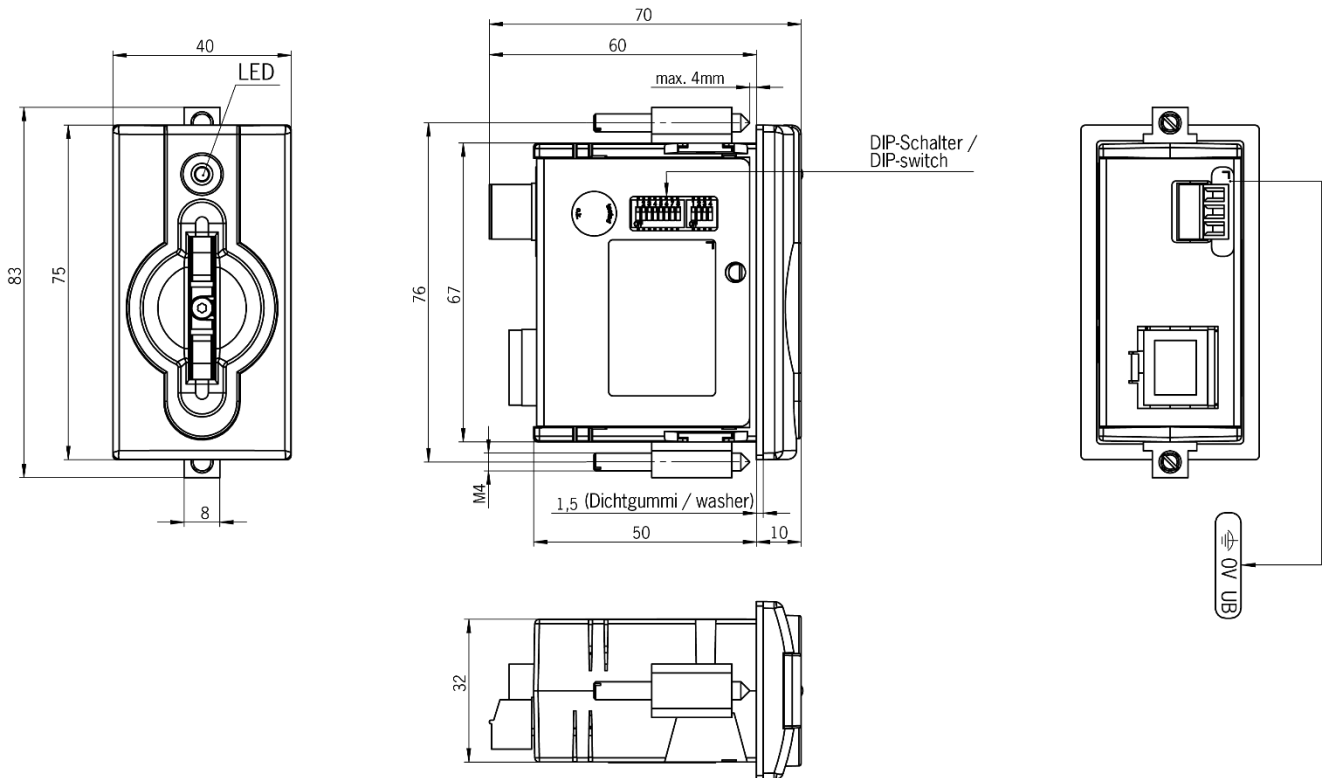

4.1.2 Version EKS-A-IEXA-G01-ST02/03/04 (EKS FSA) with Ethernet interface

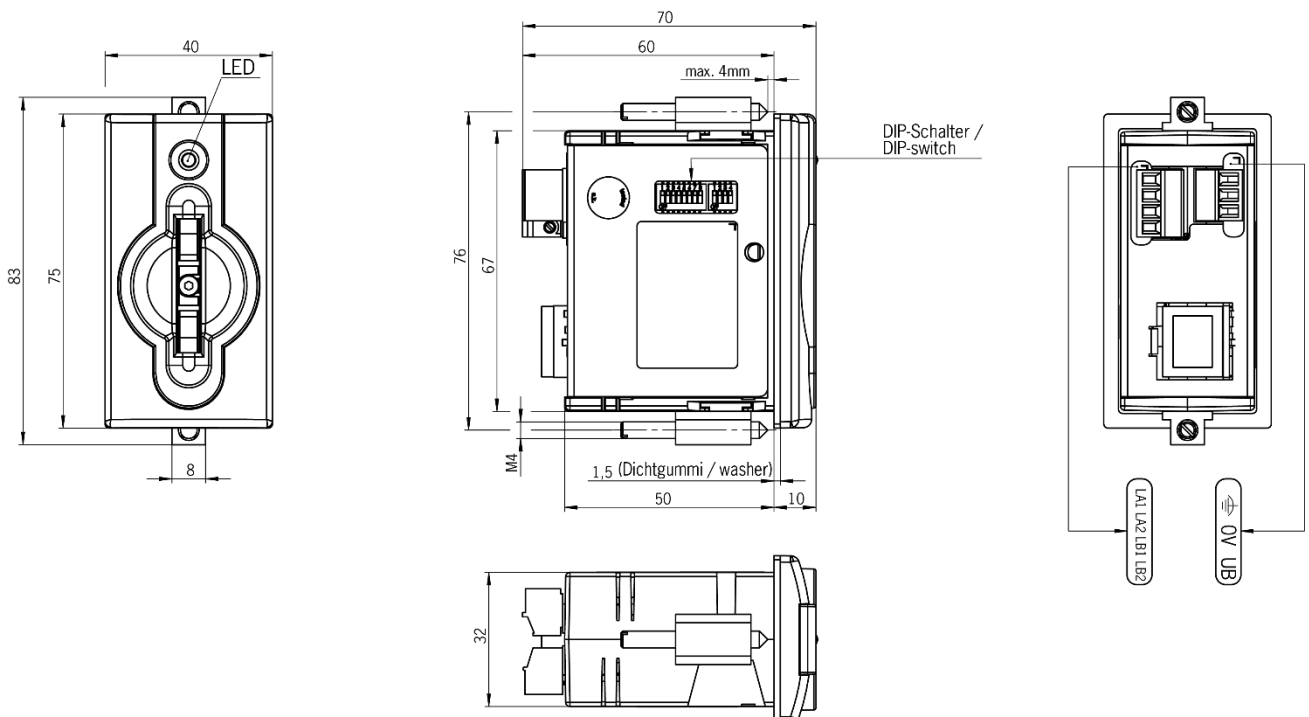

4.2 Dimension drawing of FHM Electronic-Key adapter modular

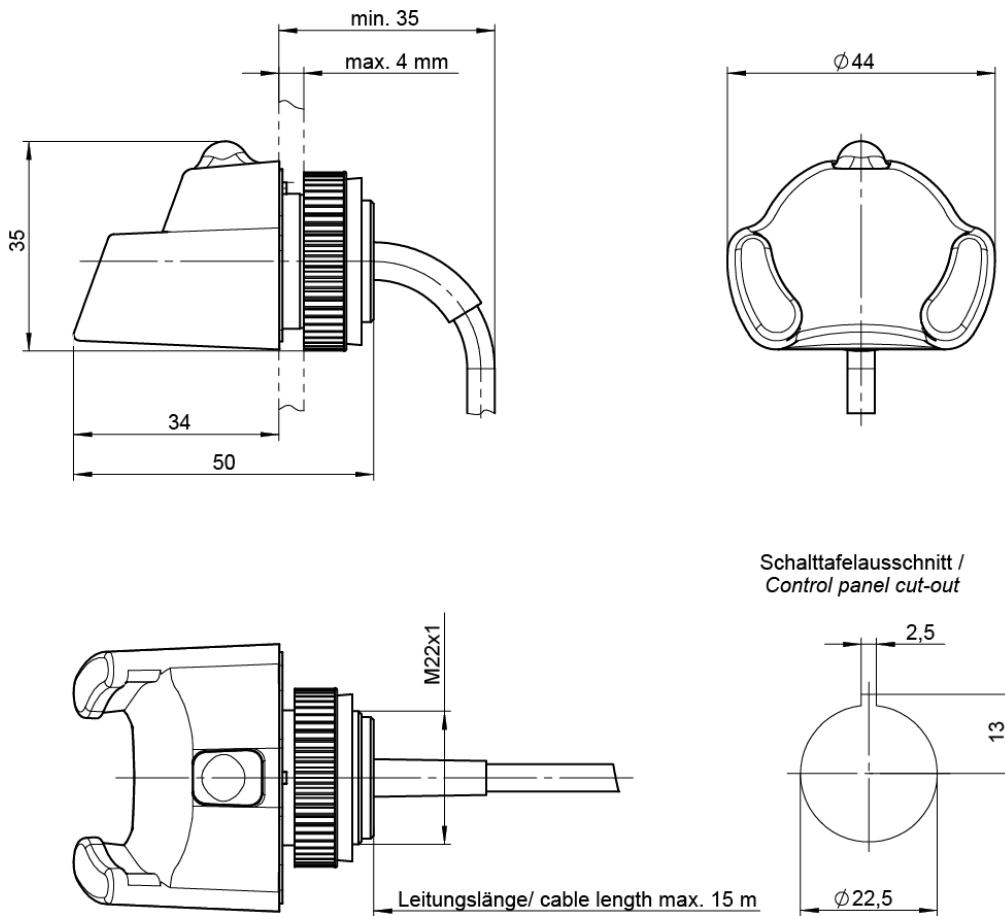

4.3 Dimension drawing of Ethernet TCP/IP modular interface adapter

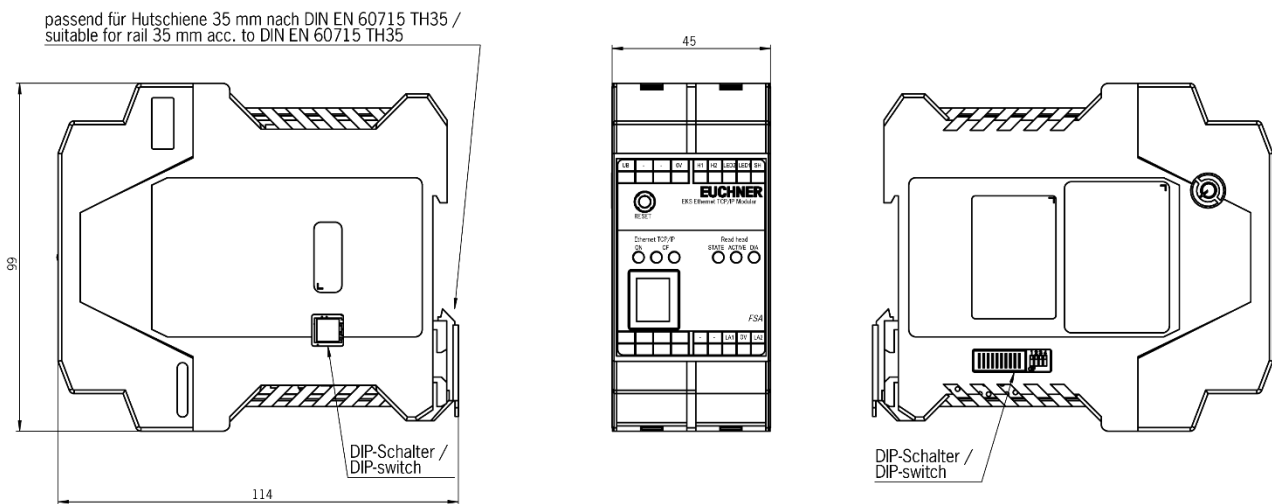

4.4 Technical data for compact version



Attention!

All the electrical connections must either be isolated from the mains supply by a safety transformer according to EN IEC 61558-2-6 with limited output voltage in the event of a fault, or by other equivalent isolation measures.

General parameters	Value			Unit
	min.	typ.	max.	
Housing	Plastic (PA 6 GF30, gray)			
Degree of protection	IP65/IP67 in installed state			
Ambient temperature at UB = DC 24 V	0		+ 55	°C
Mounting cut-out acc. to DIN IEC 61554	33 x 68			mm
Power supply connection	Plug-in connection terminal, 3-pin, with screw terminal (tightening torque 0.22 Nm), conductor cross-section 0.14 ... 1.5 mm ²			
Operating voltage U _B (regulated, residual ripple < 5 %)	20	24	28	DC V
Current consumption I _B			150	mA
Interface, data transfer				
Interface to the control system	Industrial Ethernet (IEEE 802.3)			
Transfer protocol	TCP/IP			
Data transfer rate (full duplex)	10/100			Mbit/s
Connection for Ethernet interface	1 x RJ45 socket			
Data line	2 x 2 twisted-pair copper cables, screened; min. category 5			
Cable length			100	m
LED indicator	Green: "Ready" (in operation) Yellow: "Electronic-Key active" * Red: "Fault"			
Version FSA (For Safety Applications) – parameters for floating semiconductor switching contacts LA and LB				
Switching contact connection	Plug-in connection terminal, 4-pin, with screw terminal (tightening torque 0.22 Nm), conductor cross-section 0.14 ... 1.5 mm ²			
Power supply U for load (LA, LB)		24	30	V
Switching current (with overload protection)	1	10	50	mA
Output voltage U _A (LA, LB) in switched state	U x 0.9		U	V
Resistance in switched state		35		ohms
Max. capacitive load			1	µF
Utilization category acc. to EN IEC 60947-5-2	AC-12 AC-15 DC-12 DC-13	50 mA / 24 V		
Difference time of the outputs** (LB first)		200		ms
Reliability values acc. to EN ISO 13849-1 (FSA version only)				
Category (with downstream safe evaluation)	3			
MTTF _D	Evaluation of data channel and one switching contact LA	416		years
	Evaluation of data channel and both switching contacts LA and LB	803		years
DC	92			%

* The LED illuminates yellow if there is a functional Electronic-Key in the Electronic-Key adapter.

** If the Ethernet interface is accessed during placement or removal of the Electronic-Key, the difference time can be more than 200 ms.

4.5 Technical data for modular version

Attention!

- ! All the electrical connections must either be isolated from the mains supply by a safety transformer according to EN IEC 61558-2-6 with limited output voltage in the event of a fault, or by other equivalent isolation measures.

General parameters	Value			Unit
	min.	typ.	max.	
General parameters of Electronic-Key adapter Front Hook Modular FHM				
Housing	Plastic (PVDF GF20, gray)			
Degree of protection	IP65/IP67/IP69K in installed state			
Ambient temperature	-20		+70 / +100*	°C
Mounting bore	∅ 22.5			mm
Connection	Connection cable permanently connected to Electronic-Key adapter or with plug connector in the cable, with flying lead			
Connecting cable length	2, 5, 10, 15			m
Connecting cable cross-section	4 x 0.25 screened			mm ²
Connecting cable outer sheath	PVC			
General parameters of modular interface adapter				
Housing	Plastic (PA 6.6, gray)			
Ambient temperature at U _B = DC 24 V	0		+55	°C
Mounting	35-mm mounting rail acc. to DIN EN 60715 TH35			
Number of connectible Electronic-Key adapters	1			
Connection for power supply and Electronic-Key adapter	Plug-in connection terminals, 4-pin and 5-pin, with screw terminal (tightening torque 0.22 Nm) or spring terminal, conductor cross-section 0.2 ... 1.5 mm ²			
Cable length to Electronic-Key adapter		2	15	m
Operating voltage U _B (regulated, residual ripple < 5 %)	20	24	28	DC V
Current consumption I _B			150	mA
Interface, data transfer				
Interface to the control system	Industrial Ethernet (IEEE 802.3)			
Transfer protocol	TCP/IP			
Data transfer rate (full duplex)	10/100			Mbit/s
Connection for Ethernet interface	1 x RJ45 socket			
Data line	2 x 2 twisted-pair copper cables, screened; min. category 5			
Cable length			100	m
LED indicator read head	Green (STATE): "Ready" (in operation) Yellow (ACTIVE): "Electronic-Key active" ** Red (DIA): "Error"			
LED indicator Ethernet TCP/IP	Green (ON): "Active" Red (CF): "Connection error"			
Version FSA (For Safety Applications) – parameters for floating semiconductor switching contact LA				
Switching contact connection	Plug-in connection terminal, 5-pin, with screw terminal (tightening torque 0.22 Nm) or spring terminal, conductor cross-section 0.2 ... 1.5 mm ²			
Power supply U for load (LA)		24	30	V
Switching current (with overload protection)	1	10	50	mA
Output voltage U _A (LA) in switched state	U x 0.9		U	V
Resistance in switched state		35		ohms
Max. capacitive load			1	µF
Utilization category acc. to EN IEC 60947-5-2	AC-12 AC-15 DC-12 DC-13	50 mA / 24 V		
Reliability values acc. to EN ISO 13849-1 (FSA version only)				
Category (with downstream safe evaluation)	3			
MTTF _D Evaluation of data channel and one switching contact LA	416			years
DC	92			%

* This is not an ambient temperature for operation. It is valid for a time of no more than 3 minutes, e.g. for cleaning purposes.

** The LED illuminates yellow if there is a functional Electronic-Key in the Electronic-Key adapter

4.6 Connector assignment

4.6.1 Connection socket for Ethernet interface

The connection on the read/write station is realized as an RJ45 (8P8C) socket corresponding to ISO IEC 61754-24.

Pin	Function
1	Transmit Data + (TD+)
2	Transmit Data - (TD-)
3	Receive Data + (RD+)
6	Receive Data - (RD-)

4.6.2 Connection terminal assignment for compact version



Information!

The plug-in connection terminals are included with the Electronic-Key adapter.

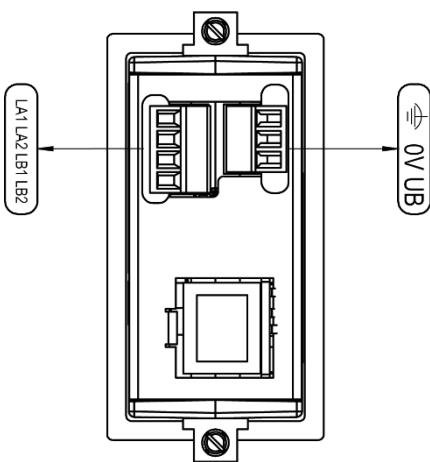
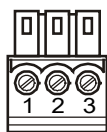

Illustration shows version FSA

4.6.2.1 Connection of power supply



Plug-in connection terminal, 3-pin, with screw terminal

Pin	Designation	Function
1	UB	Power supply DC + 24 V
2	0V	Power supply DC 0 V
3	Functional earth	Electrically connected to the housing

4.6.2.2 Plug-in screw terminals for outputs LA1/LA2 and LB1/LB2 (EKS FSA only)

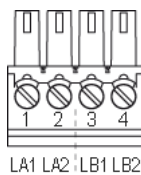

Plug-in connection terminal, 2 x 2-pin, with screw terminal

Pin	Channel	Function
1	LA	NO contact, channel LA
2		
3	LB	NO contact, channel LB
4		

4.6.3 Connection terminal assignment for modular version



Information!

The plug-in connection terminals are not included with the interface adapter

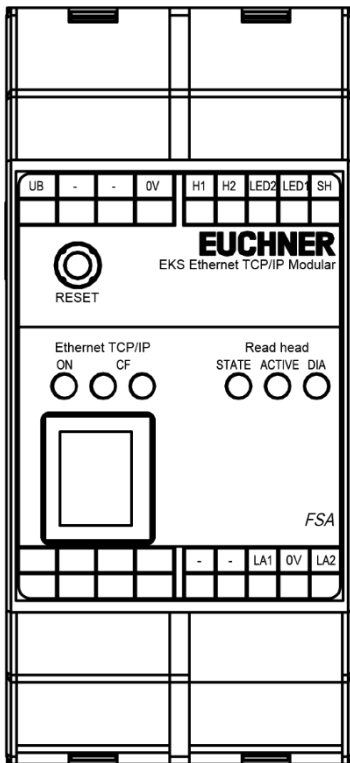

4.6.3.1 Connection to Electronic-Key adapter

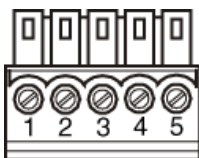

Plug-in connection terminal, 5-pin, with screw terminal or spring terminal

Pin	Designation	Function	Conductor coloring
1	SH	Shield of FHM Electronic-Key adapter	BK
2	LED1	LED of FHM Electronic-Key adapter	YE
3	LED2	LED of FHM Electronic-Key adapter	GN
4	H2	Antenna of FHM Electronic-Key adapter	WH
5	H1	Antenna of FHM Electronic-Key adapter	BN

4.6.3.2 Connection of power supply

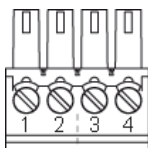

Plug-in connection terminal, 4-pin, with screw terminal or spring terminal

Pin	Designation	Function
1	0V	Power supply DC 0 V
4	UB	Power supply DC + 24 V

4.6.3.3 Connection of switching contact LA1/LA2 (EKS FSA only)

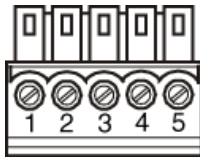

Plug-in connection terminal,
5-pin,
with screw terminal or spring
terminal

Pin	Designation	Function
1		
2		
3	LA1	
4	0V	
5	LA2	

4.7 DIP switch settings

The device has three DIP switches (S1, S2, S3).

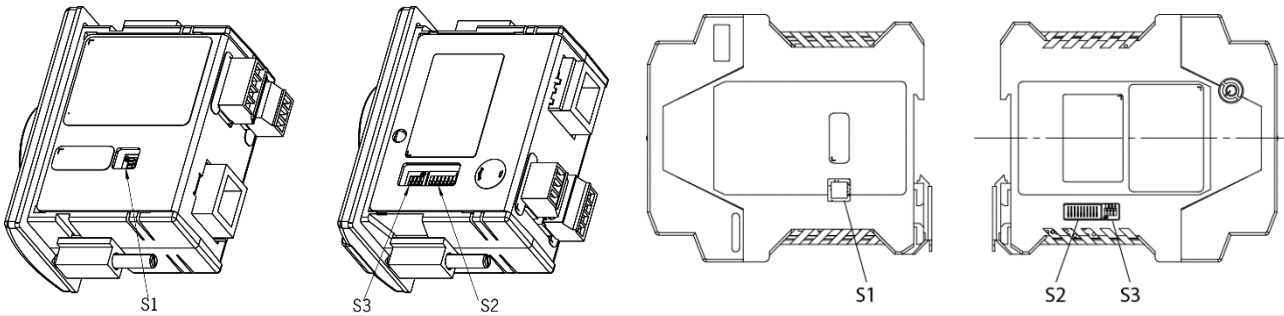

Compact device	
DIP switch	Function
S1 (4-fold)	S1.1 ... S1.4; write and read settings
S2 (8-fold)	S2.1 ... S2.8; setting of a fixed DNS name (required only for special applications)
S3 (4-fold)	S3.1 ... S3.4; settings for network connection and service
Modular device	
DIP switch	Function
S1 (4-fold)	S1.1 ... S1.4; write and read settings
S2 (10-fold)	S2.1 ... S2.10; setting of a fixed DNS name (required only for special applications)
S3 (4-fold)	S3.1 ... S3.4; settings for network connection and service



Information!

The settings are adopted only when the power supply is switched on.

4.7.1 DIP switch S1

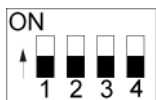

DIP switch	Function	Factory setting
S1.1	ON = write protection for Electronic-Key read/write	OFF
S1.2	No function	OFF
S1.3	No function	OFF
S1.4	No function	OFF



Information!

It is **imperative** that all DIP switches without a function (S1.2, S1.3 and S1.4) are set to **OFF!** In this way problems with any functions added in the future will be avoided.

4.7.2 DIP switch S2



DNS name	LSB								MSB	
	S2.1	S2.2	S2.3	S2.4	S2.5	S2.6	S2.7	S2.8	S2.9*	S2.10*
EKS000	OFF	OFF	OFF	OFF	OFF	OFF	OFF	OFF	OFF	OFF
EKS001	ON	OFF	OFF	OFF	OFF	OFF	OFF	OFF	OFF	OFF
EKS002	OFF	ON	OFF	OFF	OFF	OFF	OFF	OFF	OFF	OFF
EKS003	ON	ON	OFF	OFF	OFF	OFF	OFF	OFF	OFF	OFF
...
EKS254	OFF	ON	ON	ON	ON	ON	ON	ON	OFF	OFF
EKS255	ON	ON	ON	ON	ON	ON	ON	ON	OFF	OFF

* Only if modular interface adapter fitted. Internal function. Retain default setting.



Information!

Using the DIP switch S2, it is possible to set an EKS name that is used for addressing the device in the network in conjunction with a DHCP server. This name consists of the fixed code EKS plus a configurable number between 001 and 255 that can be used in all system environments with DHCP support. The station name for a specific read/write station would then be EKS027, for example.

The DIP switch S2 is relevant specifically in conjunction with the Siemens SINUMERIK DHCP address assignment routine (see chapter 6.1.1.3 Operation in the Siemens system network).

In this way it is possible to set the identical address by copying the DIP switch settings if a device is replaced.

4.7.3 DIP switch S3

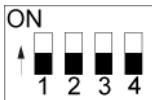

Function	S3.1	S3.2	S3.3	S3.4
Fixed IP address		OFF	OFF	OFF
Default IP address 192.168.1.1		OFF	ON	OFF
Obtain IP address from DHCP server		OFF	OFF	ON
Obtain IP address from a SINUMERIK control system		OFF	ON	ON
Internal function, leave switch OFF		OFF		
Permit configuration via the web interface	OFF	OFF	OFF	OFF

(Factory setting: all in OFF position)

= any switch position



Information!

The use of the DIP switches to assign the IP address is described in the following in chapter 6.1.1.

To prevent unauthorized changes to the network, it is sensible to deactivate the web interface after use. For this purpose switch S3.1 is set to ON.

4.8 Indicator LED of compact version

The Electronic-Key adapter operating states are indicated using a three-color LED on the front. The illumination of the LED in any color indicates the presence of the operating voltage.

Operating state	Description	Color
Electronic-Key adapter power-up or fault	After the application of the power supply, the LED is constantly illuminated red during power-up. The completion of the process is indicated by a change in this state after approx. 10 seconds. If the LED then flashes red quickly, it is an indication of a network fault.	Red
Ready	Network connected.	Green
Electronic-Key active	Network connected. Electronic-Key is in the Electronic-Key adapter.	Yellow
Acknowledgment	As soon as the voltage is applied LED flashes red/green. Default IP address is restored.	Red/green

4.9 Indicator LEDs of modular version

The operating states of the read/write stations are indicated via LEDs in three colors.

On the FHM Electronic-Key adapter, the state of the identification system is signaled by a single three-color LED. On the interface adapter, the same state is signaled by three individual LEDs (read head) in different colors. The illumination of the LED in any color indicates the presence of the operating voltage.

The state of the data interface is additionally signaled via two individual LEDs in different colors on the interface adapter (Ethernet TCP/IP).

Operating state Description	Ethernet TCP/IP		Green STATE	Read head	
	Green ON	Red CF		Yellow ACTIVE	Red DIA
Power-up of the interface adapter	flashing (2 Hz)	x*	x	x	x
Malfunction: Ethernet TCP/IP error	on	on	x	x	x
Malfunction: Error in EKS (no Electronic-Key in place)	on	x	flashing	off	flashing
Malfunction: Error in EKS (Electronic-Key in place)	on	x	flashing	flashing	off
Ready: Network connected	on	off	on	off	off
Electronic-Key active: Network connected. Electronic-Key is in the Electronic-Key adapter	on	off	on**	on	off
Acknowledgment: Default IP address is restored	flashing (1 Hz)	flashing (1 Hz)	x	x	x

* x = Any state

** Only the yellow LED is illuminated on the FHM Electronic-Key adapter

5 Mounting



Warning!

Mounting must be performed only by authorized personnel.

After mounting, again check the Electronic-Key adapter for firm seating and correct sealing on the front panel.

5.1 Electronic-Key adapter compact



Attention!

To achieve the degree of protection IP67, it is necessary to install the key adapter in a clean, flat metal plate at least 2 mm thick and to tighten the screws with a tightening torque of 0.25 ... 0.35 Nm.

Suitable strain relief must be provided for the connecting cables in order to avoid damage to the connection sockets or malfunctions.

The Electronic-Key adapter is intended for mounting in control panels with a cut-out measuring 33 mm x 68 mm according to DIN IEC 61554 (see chapter 4.1). The device is fastened using screw clamp elements from the rear side of the panel.



Information!

The screw clamp elements for front panel mounting are included with the Electronic-Key adapter.

1. Insert the Electronic-Key adapter, **with seal already bonded in place**, into the mounting cut-out from the front.
2. Insert screw clamp elements into the housing of the Electronic-Key adapter from the side up to the stop and tighten with 0.25 ... 0.35 Nm.



Attention!

The device may be damaged if the tightening torque exceeds 0.35 Nm.

5.2 Electronic-Key adapter FHM



Attention!

To achieve the degree of protection IP 69K, it is necessary to install the FHM Electronic-Key adapter in a clean, flat metal plate at least 2 mm thick and to tighten the central fixing nut with a tightening torque of 2 Nm.

Suitable strain relief must be provided for the connecting cables in order to avoid damage to the connection sockets or malfunctions.

The Electronic-Key adapter is intended for mounting in control panels with a cut-out \varnothing 22.5 mm (see chapter 4.2).

6 Electrical connection

**Danger!**

Electrical connection may be performed only by **authorized personnel trained in EMC** and with the device and wiring **isolated**.

**Warning!**

For use and operation as per the **UL** requirements, a power supply with the feature “**for use in class 2 circuits**” must be used.

**Attention!**

The read/write station is allowed to be connected only if it is electrically isolated. Otherwise the device can be damaged.

**Attention!**

If connected incorrectly, the device can be damaged. Observe electrical characteristics and terminal assignment (see chapter 4.4 Technical data for compact version and chapter 4.5 Technical data for modular version).

**Attention!**

All the electrical connections must either be isolated from the mains supply by a safety transformer according to IEC/EN 61558-2-6 with limited output voltage in the event of a fault, or by other equivalent isolation measures.

**Attention!**

When connecting, the operating organization must ensure compliance with the EMC protection requirements in accordance with EN 55011 and EN 61000-6-2.

**Attention!**

The equipotential bonding system of the machine installation must comply with EN 60204-1, section 8, Equipotential bonding.

**Attention!**

Do not lay connecting cables in the immediate vicinity of sources of interference.

6.1 Ethernet connection

The interface for the read/write station is compatible with the standards ISO/IEC 61754-24 and IEC 61158. The device is operated in full-duplex mode with 10 Mbit/s or 100 Mbit/s.



Information!

- ▶ Only a screened 100 BaseTX cable, twisted pair, Cat 5 or higher, is permitted for use as the connecting cable. The maximum cable length is 100 m.
- ▶ It may be necessary to provide additional shielding in conditions with a high level of EMC interference.
- ▶ A separate switch may be required for the Ethernet TCP/IP connection.

6.1.1 Ethernet configuration

Using the DIP switch S3, the device can be configured for the following operating modes (see chapter 4.7.3):

- ▶ With a fixed IP address
- ▶ As a DHCP client with dynamic IP address
- ▶ As a DHCP client for a SINUMERIK control system with dynamic IP address based on a fixed station name (see chapter 4.7.2)

In addition, the following service functions can be set with DIP switch S3:

- ▶ Reset to default IP address (see chapters 4.7.3 and 6.1.1.1)
- ▶ Permit or prohibit configuration via a web interface (see chapters 4.7.3 and 7.2)

The individual functions are described below in detail.

6.1.1.1 Fixed IP address and default IP address

Fixed IP address

In this operating mode, communication with the device is via a fixed IP address. In the default setting on delivery, the factory-set default IP address is 192.168.1.1 and the subnet mask is 255.255.255.0.



Information!

- ▶ This operating mode is not suitable for operation in conjunction with a DHCP server.
- ▶ The DIP switches S3.3 and S3.4 always remain OFF in this operating mode (see DIP switch settings in chapter 4.7.3).
- ▶ On powering up the device, the fixed IP address last set is always active after the application of the power supply in this operating mode.

You can assign an individual, fixed IP address via the web interface of the device (see chapter 7.2). To do this, access via a web browser must be enabled (see DIP switch settings in chapter 4.7.3).

Default IP address

Each device has the factory-set default IP address 192.168.1.1 and the subnet mask 255.255.255.0.



Information!

If you have forgotten your self-defined IP address, you can reset the device to the default address again. The self-defined address is then overwritten by the default address.

For this purpose proceed as follows. The device can be connected to the network or disconnected from the network during this routine.

1. Disconnect the device from the power supply.
2. Set DIP switch S3.3 (see DIP switch settings in chapter 4.7.3) to ON.
3. Apply power supply. Wait until the device has adopted the default IP address. This situation is indicated by the LED flashing red/green.
4. Disconnect the device from the power supply. Set DIP switch S3.3 to OFF (see DIP switch settings in chapter 4.7.3).

After the application of the power supply, the device now powers up again with the default IP address. A new, fixed, self-defined IP address can now be set again using the web interface (see above).

**Information!**

With the modular interface adapter, the RESET button on the front can be used to disconnect the power supply and restart the device.

6.1.1.2 Dynamic IP address

In this operating mode, the device is a DHCP client. The IP address is assigned by a DHCP server (see DIP switch settings in chapter 4.7.3).

**Information!**

This operating mode is unsuitable for operation in a network with fixed IP addresses.

6.1.1.3 Operation in the Siemens system network

The Siemens system architecture is designed so that the HMI PRO (Human Machine Interface) software and the operating system run on one or more NCU (Numeric Control Units)/IPC (Industrial PCs). The TCP/IP protocol is used for communication.

The EKS communicates with an NCU. Linux is used here as the operating system in the NCU. Simple TCUs (Thin Client Units) with MCPs (Machine Control Panels) are provided at the control station for operation and visualization. A control station typically consists of a TCU and MCP. Communication between TCU, MCP and NCU takes place completely via Ethernet.

The EKS communicates with an IPC. Windows® is used as the operating system here. If the EKS is to be operated remotely from the IPC, the EKS with Ethernet interface can be used.

Each station in a system network is assigned an unambiguous SINUMERIK station name. The EKS can be integrated into this network. According to the principle of flexible assignment of stations to each other, it is possible to define which stations are to work together, i.e. which TCU is to access which NCU/IPC with which MCP. This means that an EKS can be assigned to a specific control station.

A DHCP server runs on the NCU/IPC, and a DHCP client runs on the connected network stations. With this SINUMERIK DHCP address assignment routine, an unambiguous SINUMERIK station name is made up of an assigned device name and a number. In the case of the EKS, this station name consists of the identifier EKS and a consecutive number between 001 and 254 (around 1 byte). The numbers 000 and 255 are not supported by the SINUMERIK address assignment routine. The station name for a specific EKS would then be EKS027, for example. No programming device or PC is required for setup within the Siemens network. When carrying out setup, it must be ensured that each device receives a separate number in a network. An unambiguous IP address is then dynamically assigned to this name via DHCP. DNS is used to ensure that each device can be addressed by its name.

The EKS can obtain the IP address corresponding to the SINUMERIK DHCP address assignment routine. Activation of the SINUMERIK address assignment routine must be set by means of the DIP switch S3 (see chapter 4.7.3). The 3-digit numbering as part of the station name (i.e. 027 in the example above) can be set by means of the DIP switch S2 (see chapter 4.7.2).

System integration in the user software is performed by Siemens.

6.2 Connection of power supply

(For connector assignment see chapters 4.6.2.1 and 4.6.3.2)

It is imperative that the following points are observed:

The connections must be made as appropriate to maintain EMC performance.

A power supply of suitable EMC performance must be used for the power supply.

Conductor cross-section maximum 1.5 mm².

- ▶ Tighten the screws on the terminal plug to 0.22 Nm.



Information!

With the modular interface adapter, the RESET button on the front can be used to disconnect the power supply and restart the device.

6.3 Connection of functional earth

The functional earth is connected via terminal 3 on the plug-in screw terminals for the power supply. This connection is electrically connected internally to the housing of the compact Electronic-Key adapter.



Information!

The functional earth must be connected to PE!

6.4 Connection of the semiconductor switching contacts (for EKS FSA only)



Warning!

Incorrect connection or errors in the safety-related integration of the EKS FSA can lead to fatal injury. For this reason, observe the following safety aspects:

- ▶ It is not possible to generate a safe signal by using only the switching contacts LA1/LA2 and LB1/LB2. Safe, downstream evaluation is always necessary. Use of the switching contact LB1/LB2 (for the compact version only) is optional.
- ▶ Safe evaluation must always be dual-channel:
Evaluation of switching contact LA1/LA2 as channel LA together with evaluation of the data line as channel LB.



Information!

The switching contact LA1/LA2 is used in combination with functionally safe applications. The function that can be evaluated in terms of safety engineering is the reliable detection that no Electronic-Key is placed.

7 Setup

Perform setup in the following sequence:

1. Set the DIP switches of the device (see chapter 4.7).
2. Check whether mounting and electrical connection are correct (see chapter 5 and chapter 6).
3. After the power supply is plugged in, the LED on the front of the compact Electronic-Key adapter is illuminated, or the CF LED on the interface adapter are initially illuminated red. After the EKS has booted and a network cable has been connected, the LED on the front of the compact Electronic-Key adapter is illuminated, or the ON LED on the interface adapter is illuminated green and signals readiness for operation.
4. Place the Electronic-Key in the Electronic-Key adapter. The LED on the front of the compact Electronic-Key adapter or the ACTIVE LED on the interface adapter changes to yellow.
5. Important: for the version EKS *FSA*, all safety functions must also be thoroughly tested.

7.1 Network settings

You need the following information to integrate the device into the network:

- ▶ IP address of the host computer with which you want to configure the device.
- ▶ Free IP address that can be assigned to the device (not needed if the IP address is obtained automatically from a DHCP server)
- ▶ Subnet mask of the network in which the device is to be operated
- ▶ If necessary, information on valid gateway
- ▶ If necessary, information on valid DNS server



Information!

The TCP connection to the device must be made using port 2444. If the Ethernet ActiveX® module is used, this port is set by default. If the connection is to be made from a control system, for example, this port must be set explicitly.

7.1.1 Network settings for a configuration PC with Windows®



Information!

- ▶ It is assumed that you connect the PC to the EKS read/write station as shown in the following example.
- ▶ For connection, you need a (Cat 5) patch cable.
- ▶ You must first modify the network settings on the PC so that the web interface can be opened.
- ▶ Enter IP address for the PC from 192.168.1.2 to 192.168.1.254.
- ▶ Enter subnet mask for the PC as 255.255.255.0

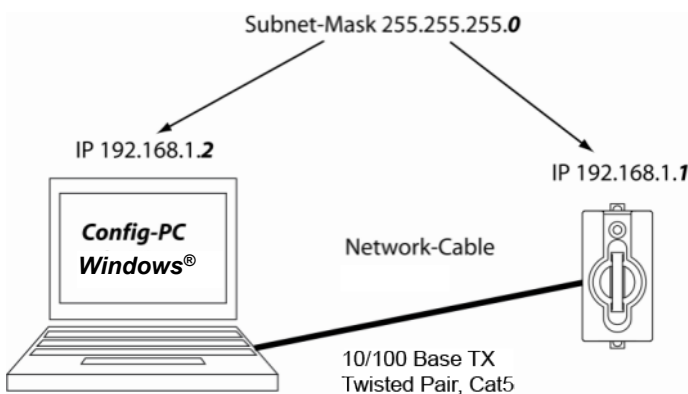
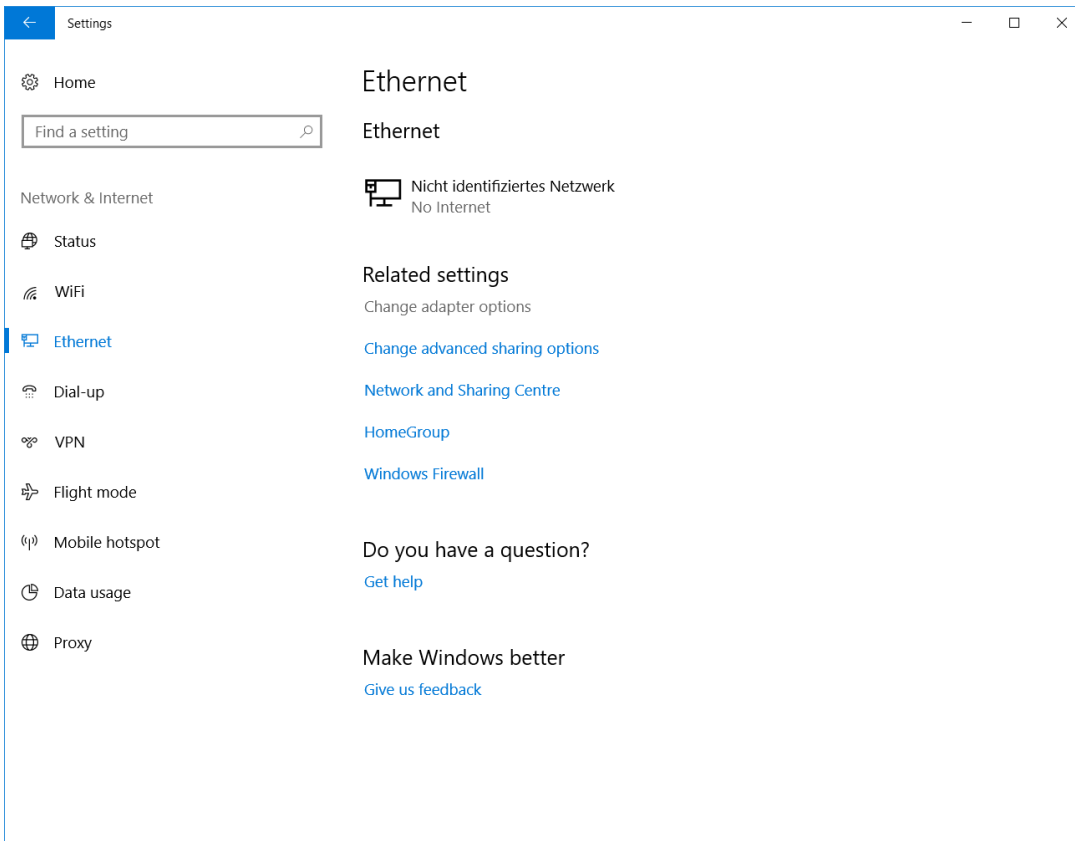

Figure 4: Connection of configuration PC

Adapting network settings

1. Select **Network & Internet** in your operating system and click **Change adapter options**.



2. Right-click **Ethernet** and then click **Properties**.

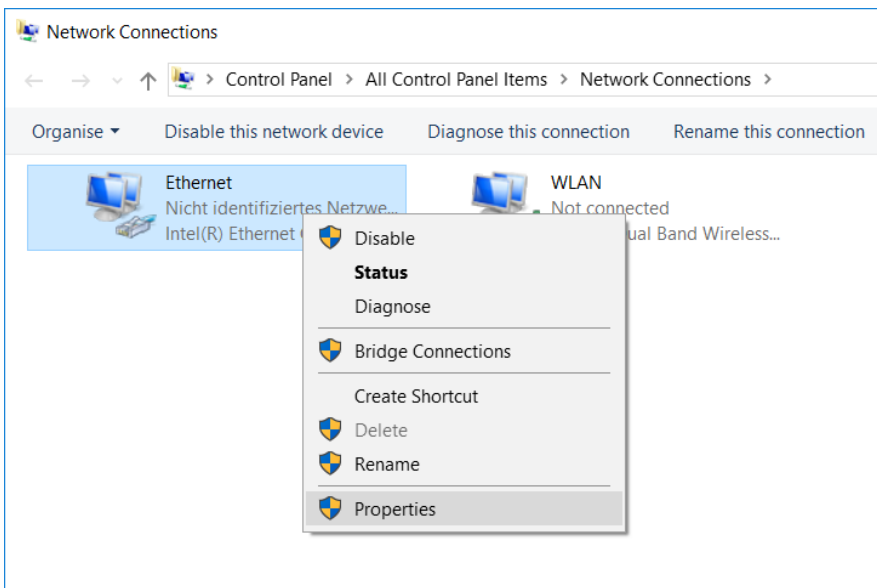

3. Open the **Properties** for **Internet Protocol Version 4 (TCP/IPv4)**.

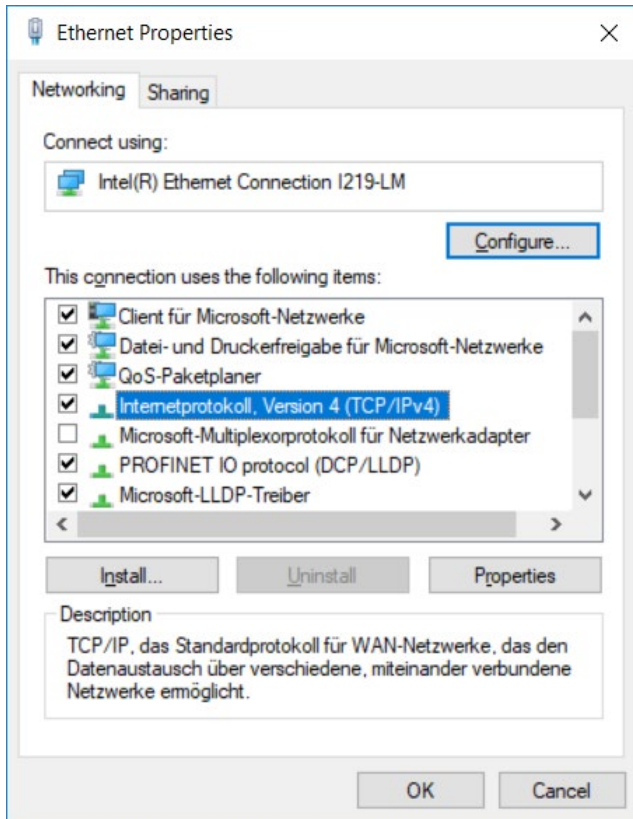

4. In order to ensure that the EKS read/write station and the configuration computer are in the same network, you must assign your configuration PC an IP address with the same subnet mask as the device. On delivery, the default IP of the device is 192.168.1.1 and the subnet mask is 255.255.255.0. As a consequence you can allocate to the configuration computer any IP address between 192.168.1.2 and 192.168.1.254, for example. In this example, the configuration PC is assigned the IP address 192.168.1.2.

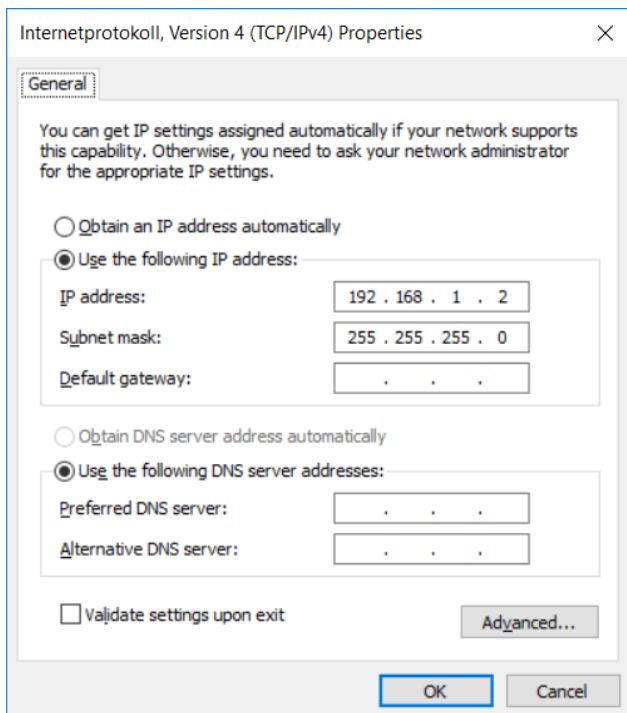

5. Click the **OK** button to confirm your entries.

The EKS read/write station can now be configured via the integrated web interface as described in chapter 7.2.

2. Click **Configuration**.

► The **Configuration** screen for the EKS web interface is now displayed.



3. Enter the desired IP address and the subnet mask. If the network has a gateway, also enter this information.

4. Click the **Send** button.

► The following message is displayed: **The settings were saved, to apply settings please switch power off/on...**

5. Interrupt the power supply and connect the device again in order to adopt the settings.

Information!



With the modular interface adapter, the RESET button on the front can be used to disconnect the power supply and restart the device.

The areas of the web interface described in the following are used for the extended analysis of the connection from the EKS to the software application.

In the **Active Connection Data** area, the number of currently active connections is shown including the parameters for the connection to the application. Here only one connection is allowed to be active. If there are more than three connections, the EKS outputs the status number 61_{hex} (see chapter 8.5) and the communication is interrupted. The connection to the web interface is not indicated here. The active connections are deleted when the device is shut down.

In the **Connection Data History** area, the total number of all boot processes is indicated after **Current Boot Count**. The last 20 EKS connections to the application are also listed chronologically with the connection parameters. These entries are not deleted while resetting to the default IP address (see chapter 6.1.1.1).

8 Data transfer via the Ethernet TCP/IP interface

8.1 Communication

This chapter primarily describes communication between a PC and the read/write station (referred to as the *device* in the following).

The commands

- ▶ Program (write) Electronic-Key
- ▶ Read Electronic-Key

are issued using the TCP/IP protocol.

Integration of the read/write station with Ethernet interface into the user's PC application is supported by an optionally available ActiveX® module (order no. 100665) (usable if user programs under MS Windows® support ActiveX®). The EKS can thus be used in conjunction with process visualization, for example. **The ActiveX® module is used as a protocol driver for the TCP/IP data transfer protocols described in the following.**

Upon request, Euchner will make available a shared library as an interface to a Linux operating system.



Information!

The shared library only supports the EKS during reading.

To ensure communication stability, a maximum of one connection to the application is allowed. In parallel, an additional connection can be established via the web interface.

8.2 Basic message structure

8.2.1 IP – Internet Protocol

The internet protocol defines the basis for data transfer. It guarantees data transfer by connectionless, unsecured transport of data packets. IP provides an addressing mechanism for unambiguously identifying the transmitter and receiver. This is done by means of IP addresses.

In addition to the actual user data that are to be transferred, a data packet also contains other important information to facilitate problem-free data transfer. This additional information is also referred to as the packet overhead or header.

8.2.2 TCP – Transport Control Protocol

TCP takes care of the handling and security of the IP data packets. It establishes a connection between two network stations for the duration of data transfer. The conditions for data transfer (e.g. the size of the data packets) are defined when the connection is set up. TCP operates according to the so-called client-server principle. The network station that sets up a connection represents the client. The addressed network station is known as the server.

TCP provides every data packet with a checksum and therefore ensures that any data loss is detected. A sequence number is also transferred that calculates a so-called acknowledge number according to a fixed algorithm. This acknowledge number is sent back to the transmitter. In this way, the receiver acknowledges that the data packet has been received correctly. If this is not the case, the receiver requests the data packet again.

A further task of TCP is forwarding of data packets to the correct application. These applications (so-called services) are addressed by means of different port numbers (e.g. port 80 for HTTP).

8.3 Commands for writing and reading an Electronic-Key read/write

Write and read processes are always initiated by the PC/control system using a “command message.”

The command message and reply message are also packed as user data in the TCP/IP frame.

The Electronic-Key-System then sends a reply message to the PC/control system.

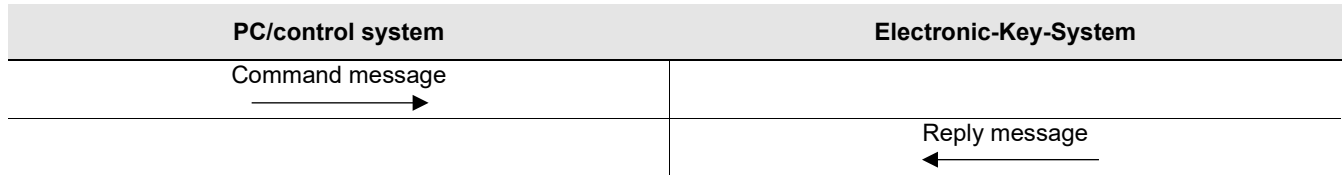

Information!

On the Electronic-Key read/write with 116 bytes freely programmable, the memory is organized in 4-byte blocks. This means the start address for writing must be given in the range byte number 0 to byte number 112, always in 4-byte steps (byte number 0, 4, 8 ... 112). Also, a multiple of 4-byte-sized blocks must always be written (4, 8, 12 ... 116 bytes)!

However, during reading it is possible to access the memory byte-by-byte without the above-mentioned restriction for writing.

The Electronic-Key read/write also has a unique 8-byte serial number that is permanently written to the memory during the Electronic-Key production process. The serial number therefore cannot be changed. This serial number is used for secure differentiation of every single Electronic-Key. It is necessary that all 8 bytes are completely evaluated for secure differentiation. The serial number is appended to the freely programmable memory. The serial number can be read by entering the start address byte number 116 and the number of bytes 8.

8.3.1 Write process



Information!

When this command is used, the Electronic-Key must be in the Electronic-Key adapter, and must be removed from within the actuating range only after the reply message has been received.

Command message (message core, PC/control system → EKS, see Figure 5):

- ▶ TP (device addr.) (start addr. user data) (number of bytes of user data) (user data)

Reply message (message core, EKS → PC/control system, see Figure 6):

- ▶ RF (device addr.) (00_{hex}, 00_{hex}) (status number)

Byte no.	Description	Contents		
		ASCII	hexadecimal	decimal
0	Number of message bytes		0B ... 7B	11 ... 123
1	Command identification	T	54	84
2		P	50	80
3	Constant		01	1
4	Start address for the user data		00	0
5			00 ... 70	0 ... 112
6	Number of bytes of user data		04 ... 74	4 ... 116
7 ... 122	User data	ASCII or hexadecimal or BCD (code transparent)		

Figure 5: Command message **Write Electronic-Key read/write** (message core)

Byte no.	Description	Contents		
		ASCII	hexadecimal	decimal
0	Number of message bytes		07	7
1	Command identification	R	52	82
2		F	46	70
3	Constant		01	1
4	Padding data		00	0
5			00	0
6	Status number		*	

Figure 6: Reply message **Write Electronic-Key read/write – status** (message core)

- * Status number
 - 00_{hex}: without errors
 - 02_{hex}: Electronic-Key not in the actuating range
 (for further status numbers see chapter 8.5)

8.3.2 Read process

Command message (message core, PC/control system → EKS, see Figure 7):

- ▶ TL (device addr.) (start addr. user data) (number of bytes of user data)

Reply message (message core, EKS → PC/control system, see Figure 8 or Figure 9):

For this command there are two possible replies:

- ▶ RL (device addr.) (start addr. user data) (number of bytes of user data) (user data)
- or
- ▶ RF (device addr.) (00_{hex}, 00_{hex}) (status number)

The reply message RL (see Figure 8) stands for correct reception of the data.

If an Electronic-Key cannot be read, an RF reply message is received (see Figure 9). The status number then indicates the cause of the error.

Byte no.	Description	Contents		
		ASCII	hexadecimal	decimal
0	Number of message bytes		07	7
1	Command identification	T	54	84
2		L	4C	76
3	Constant		01	1
4			00	0
5	Start address for the user data		00 ... 74	0 ... 116
6	Number of bytes of user data		01 ... 7C	1 ... 124

Figure 7: Command message **Read Electronic-Key read/write** (message core)

Byte no.	Description	Contents		
		ASCII	hexadecimal	decimal
0	Number of message bytes		08 ... 83	8 ... 131
1	Command identification	R	52	82
2		L	4C	76
3	Constant		01	1
4			00	0
5	Start address for the user data		00 ... 74	0 ... 116
6	Number of bytes of user data		01 ... 7C	1 ... 124
7 ... 130	User data	ASCII or hexadecimal or BCD (code transparent)		

Figure 8: Reply message **Read Electronic-Key read/write** (message core)

Byte no.	Description	Contents		
		ASCII	hexadecimal	decimal
0	Number of message bytes		07	7
1	Command identification	R	52	82
2		F	46	70
3	Constant		01	1
4	Padding data		00	0
5			00	0
6	Status number		*	

Figure 9: Reply message **Read Electronic-Key read/write – status** (message core)

* Status number 02_{hex}: Electronic-Key not in actuating range
 (for further status numbers see chapter 8.5)

8.3.3 Reading the serial number

The Electronic-Key read/write also has a unique 8-byte serial number that is permanently written to the memory during the Electronic-Key production process. The serial number therefore cannot be changed. This serial number is used for secure differentiation of every single Electronic-Key. It is necessary that all 8 bytes are completely evaluated for secure differentiation. The serial number is appended to the freely programmable memory. The serial number can be read by entering the start address byte number 116 and the number of bytes 8 (see chapter 8.3.2).

8.3.4 Read the Electronic-Key status

Command message (message core, PC/control system → EKS, see Figure 10):

- ▶ Ek (device addr.) (00_{hex}, 00_{hex}) (00_{hex})

Reply message (message core, EKS → PC/control system, see Figure 11):

There is only one reply for this command:

- ▶ Ek (device addr.) (00_{hex}, 00_{hex}) (status number)

Byte no.	Description	Contents		
		ASCII	hexadecimal	decimal
0	Number of message bytes		07	7
1	Command identification	E	45	69
2		k	6B	107
3	Constant		01	1
4	Padding data		00	0
5			00	0
6			00	0

Figure 10: Command message **Read Electronic-Key status** (message core)

Byte no.	Description	Contents		
		ASCII	hexadecimal	decimal
0	Number of message bytes		07	7
1	Command identification	E	45	69
2		k	6B	107
3	Constant		01	1
4	Padding data (can be different values)		XX	X
5			XX	X
6	Status number		*	

Figure 11: Reply message **Read Electronic-Key status – status** (message core)

- * Status number
 - 01_{hex}: EKS_KEY_IN
 - 02_{hex}: EKS_KEY_OUT
 - 03_{hex}: EKS_KEY_OTHER



Information!

The current status of the EKS Electronic-Key can be polled actively at any time using the command identification **Ek**. The EKS device responds also with command identification **Ek** and the information on whether an Electronic-Key is in place or not.

This status message is sent automatically by the EKS also without request via the command message, as soon as the Electronic-Key is put in place or removed.

8.4 Command overview

Description	Command message	Reply message
Program Electronic-Key	TP (see chapter 8.3.1)	RF (see chapter 8.3.1)
Read Electronic-Key (also read the serial number)	TL (see chapters 8.3.2 and 8.3.3)	RL (see chapter 8.3.2) or RF (see chapter 8.3.2)
Read the Electronic-Key status	Ek (see chapter 8.3.4)	Ek (see chapter 8.3.4)

8.5 Status numbers

Value	Description
00 _{hex}	No error
02 _{hex}	Electronic-Key not in the actuating range
03 _{hex}	Parity bit error on read-only Electronic-Key
06 _{hex}	Write process interrupted. Start address or number of bytes is not a multiple of the block size 4.
4x _{hex}	General Electronic-Key communication error (renewed write or read process necessary)
50 _{hex}	Write attempt despite enabled write protection
61 _{hex}	Maximum permissible number of TCP/IP connections exceeded

9 Exclusion of liability

Exclusion of liability under the following circumstances:

- ▶ Incorrect use
- ▶ Non-compliance with safety regulations
- ▶ If mounting and electrical connection are carried out by unauthorized personnel
- ▶ If modifications are made

10 Service and repair

- ▶ No servicing is required.
- ▶ Remove dirt from the Electronic-Key and the Electronic-Key adapter using a soft cloth and solvent-free, non-abrasive cleaning agents.
- ▶ Repairs are to be made only by the manufacturer.
- ▶ On version EKS *FSA* devices, the safety-related functions must be checked at regular intervals.

11 Guarantee

The "General Terms and Conditions" of EUCHNER GmbH + Co. KG apply.

EUCHNER GmbH + Co. KG
Kohlhammerstraße 16
70771 Leinfelden-Echterdingen

Phone +49 711 / 75 97 - 0
Fax +49 711 / 75 33 16
www.euchner.com . support@euchner.de

Microsoft Windows® and ActiveX®
are registered trademarks of
Microsoft Corporation

EUCHNER
More than safety.