

EUCHNER

Operating Instructions

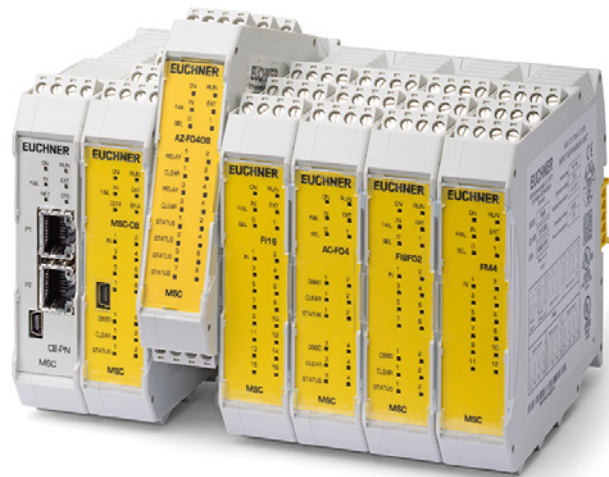

MODULAR SAFETY CONTROL SYSTEM MSC
MSC FIELDBUS MODULES CE-...

EN

Contents

1.	About this document.....	4
1.1.	Scope.....	4
1.2.	Target group	4
1.3.	Key to symbols.....	4
1.4.	Supplementary documents	4
2.	Introduction.....	5
3.	Electrical connections.....	5
3.1.	Connection of a fieldbus module	6
4.	Layout of the protocol data packet.....	7
4.1.	Cyclic process image.....	7
4.2.	Acyclic process image / diagnostics	8
4.2.1.	“I/O index” field.....	9
4.2.2.	“Diagnostic code” field	10
4.3.	Input structure	11
4.4.	Cyclic / acyclic process image	12
4.5.	Configuration of the input and output structure – backward compatibility.....	15
4.6.	Input status of the SPM modules.....	16
5.	Signals and pin assignment.....	17
5.1.	Module CANopen CE-CO.....	17
5.2.	Module DeviceNet CE-DN	18
5.3.	Module PROFIBUS CE-PR.....	19
5.4.	Module EtherCAT CE-EC	19
5.5.	Module EtherNet/IP CE-EI	20
5.6.	Module PROFINET CE-PN.....	20
5.7.	Module Modbus TCP/IP CE-MT.....	21
5.8.	Module Modbus RTU CE-MR.....	21
5.9.	Module PROFINET CE-US.....	22
6.	Example diagnostics.....	23
6.1.	Example 1.....	23
6.2.	Example 2.....	23
6.3.	Example 3.....	24
7.	“Bus Configurator” user interface.....	25
7.1.	Graphic user interface.....	26
7.2.	Example EUCHNER Safety Designer configuration	29

8.	Process data mapping	31
8.1.	General Notes	31
8.2.	EtherCAT (MSC CE-EC).....	31
	8.2.1. PDO predefined connection set	31
	8.2.2. Process data mapping (PDO)	31
	8.2.3. Vendor specific Objects.....	32
8.3.	CANopen (MSC CE-CO).....	37
	8.3.1. PDO predefined connection set	37
	8.3.2. Process data mapping (PDO)	37
	8.3.3. Vendor specific Objects.....	39
8.4.	EtherNet/IP (MSC CE-EI).....	43
	8.4.1. Process data mapping (Class 1 Connection)	43
	8.4.2. Explicit messaging ¹	44
8.5.	DeviceNet (MSC CE-DN)	45
	8.5.1. Process data mapping	45
	8.5.2. Explicit messaging ¹	45
8.6.	Modbus TCP/IP (MSC CE-MT) / Modbus Serial (MSC CE-MR)	46
	8.6.1. Register mapping.....	46
8.7.	CC-LINK (MBCCL).....	48
	8.7.1. Process data mapping	48
8.8.	PROFINET (MSC CE-PN).....	50
	8.8.1. Process data mapping	50
	8.8.2. Record Data read/write services ¹	51
8.9.	PROFIBUS DP (MSC CE-PR).....	52
	8.9.1. Process data mapping	52
	8.9.2. Record Data read/write services ¹	53
8.10.	Acyclic data format.....	54
	8.10.1. Errors data CPUx format	54
	8.10.2. Input diagnostics format.....	54
	8.10.3. OSSD diagnostics format	54
	8.10.4. Project CRC format.....	54

1. About this document

1.1. Scope





These operating instructions are valid for FIELDBUS MODULES CE-... MSC. These operating instructions and any brief instructions enclosed form the complete user information for your device.

	<p>Important!</p> <p>Make sure to use the operating instructions valid for your product version. Please contact the EUCHNER Service team if you have any questions.</p>
---	--

1.2. Target group





Design engineers and installation planners for safety devices on machines, as well as setup and servicing staff possessing special expertise in handling safety components.



1.3. Key to symbols

Symbol/depiction	Meaning
	Printed document
	Document is available for download at www.euchner.com
 DANGER WARNING CAUTION	<p>Safety precautions</p> <p>Danger of death or severe injuries</p> <p>Warning about possible injuries</p> <p>Caution slight injuries possible</p>
 NOTICE Important!	<p>Notice about possible device damage</p> <p>Important information</p>
Tip!	Useful information
FW < 2.0	Fieldbus module firmware version < 2.0
FW ≥ 2.0	Fieldbus module firmware version ≥ 2.0

1.4. Supplementary documents

The overall documentation for this device consists of the following documents:

Document title (document number)	Contents	
Safety information (2525460)	Basic safety information	
Operating Instructions MODULAR SAFETY CONTROL SYSTEM MSC (2121341)	(this document)	
Declaration of conformity	Declaration of conformity	
Possibly brief instructions enclosed	Take any associated additions to the operating instructions or data sheets into account	

 	<p>Important!</p> <p>Always read all documents to gain a complete overview of safe installation, setup and use of the device. The documents can be downloaded from www.euchner.com. For this purpose enter the doc. no. in the search box.</p>
--	--

2. Introduction

The operation of the fieldbus modules in the series MSC is described in this technical data sheet:

CE-PR (PROFIBUS DP-V1), CE-DN (DeviceNet), CE-CO (CANOpen), CE-EC (ETHERCAT), CE-EI (Ethernet I/P - 2 PORT), CE-PN (PROFINET), CE-MT (Modbus TCP), CE-MR (Modbus RTU), CE-US (USB).

3. Electrical connections

Each module has four connections (Fig. 1):

1. MSCB plug connector, 5-pin → to the MSC system
2. USB Mini-B plug connector → to the PC
3. BUS plug connector → to the fieldbus (not available on CE-US)
4. Front connection → power supply

Terminal block (side A - top)	
Terminal	Signal
1	24 VDC ± 20 %
2	-
3	-
4	GND

Table 1: Terminal assignment



WARNING

- › Install safety modules in a control cabinet that meets degree of protection IP54 as a minimum.
- › The power supply for the modules must be 24 VDC ± 20 % (PELV, as per EN 60204-1).
- › MSC is not allowed to be used to supply external devices.
- › The same ground connection (0 VDC) is to be used for all system components.

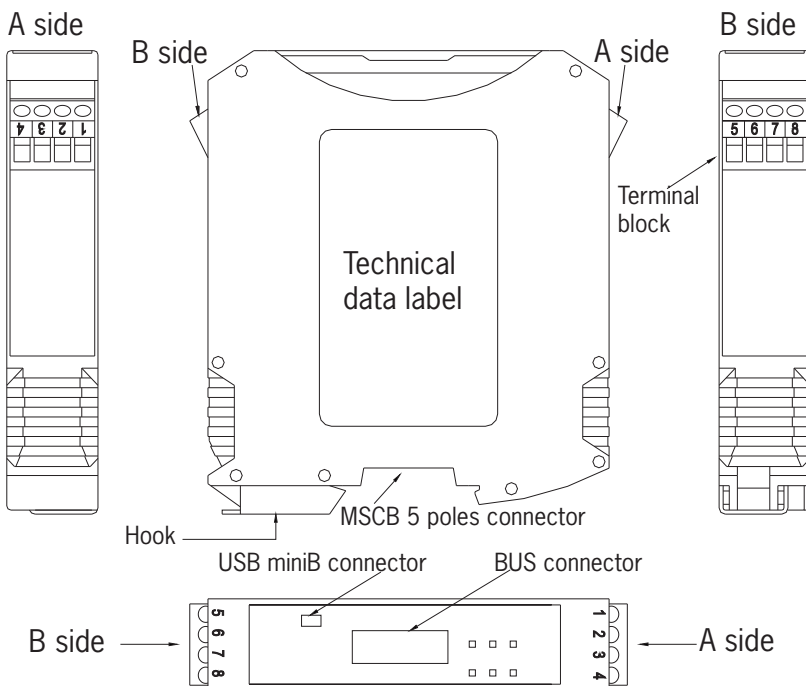

Fig. 1: Connection overview

3.1. Connection of a fieldbus module

The diagram below is used to clarify the possible connections:

1. Connection of a fieldbus module with network interface
 - › Connect to a PC via a USB cable (Mini-USB port) to configure the module and, if required, to monitor the data received from the source.
 - › Connect to a PLC to exchange data (both cyclically and acyclically) via the network interface.
2. Connection of a fieldbus module MSC-CE-US
 - › Connect to a PC via a USB cable (USB port "C") to configure the module and, if required, to monitor the data received from the source.
 - › Connection to a PLC is not intended because this module type is not equipped with a network interface.

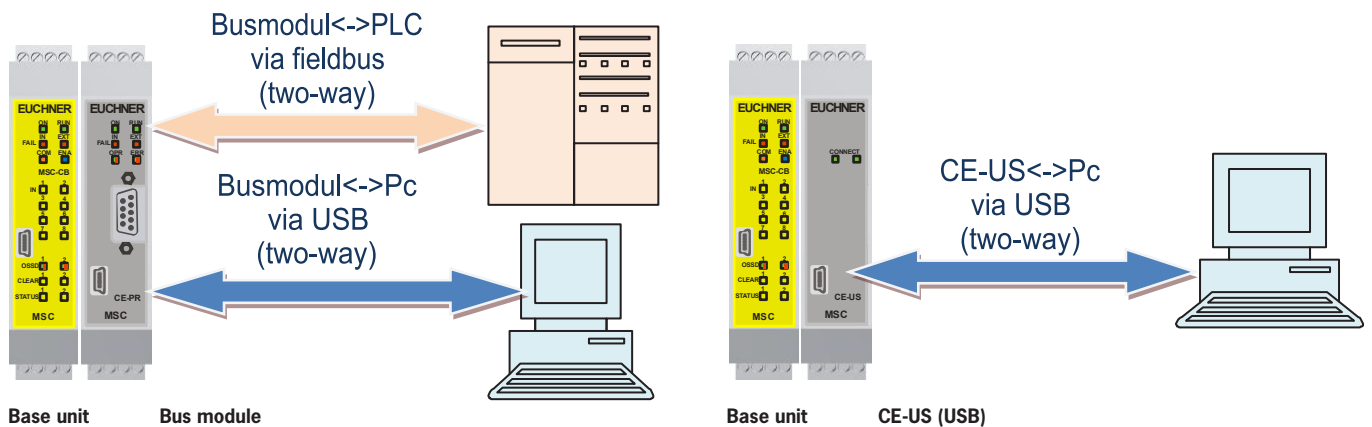

Fig. 2: Connection examples

4. Layout of the protocol data packet

The fieldbus module permits the connection of the MSC system to a higher level control unit via a fieldbus interface.

The MSC system status as well as the I/O status (status of the MSC inputs and outputs) are made available via cyclic data, while access to I/O diagnostics, system errors and the CRC for the MSC program is via acyclic data.

The higher level control system can read up to 32 on/off statuses via the fieldbus module. This status information is available as non-safe inputs in the MSC program.

The input and output structures of the fieldbus modules are shown in chapters 4.3 and 4.4.



NOTICE

- › The input and output structures are represented from the viewpoint of the MSC system.
- › On fieldbuses in which the data frames are specified (e.g. PROFIBUS), the input bytes must precede the output bytes.

4.1. Cyclic process image

The cyclic process image consists of several sub-sections of fixed size: System status, Status of the MSC inputs, Copy of the fieldbus inputs, Status of the fieldbus outputs, Status of the MSC safety outputs.

1. System status

The system status is indicated by one byte:

- › Bit 0 indicates whether the MSC system is online or offline
- › Bit 1 indicates whether diagnostic information is available
- › Bit 2 indicates whether there is an error in the MSC system (only firmware version ≥ 2.0)

Each input and each safety output (OSSD) configured in the MSC system is linked to two information elements: Status and Diagnostics.

If the corresponding bit in the system status is set, diagnostic messages are available. The detailed diagnostic messages and errors related to the inputs and outputs can be queried via the acyclic data.

2. Status of the MSC inputs

16 bytes are available in the process image for the status of the MSC inputs. As such the status of up to 128 inputs can be depicted. Each module with inputs has a number of bits that corresponds to the number of inputs present. For this reason, the modules MSC-CB, MSC-CB-S, FI8, FI8FO2 and FI8FO4S are linked to one byte (8 bits) and the modules FI16 and FM4 to two bytes (16 bits) for the input status.

Depending on the type of the respectively installed modules, the position of the inputs varies in the following sequence: MSC-CB/MSC-CB-S, FI8FO2, FI16, FI8, FM4, SPM2, SPM1, SPM0, FI8FO4S. If several modules of the same type are installed, the order corresponds to the node number.

3. Copy of the fieldbus inputs

A copy of the status of the fieldbus inputs is depicted in the cyclic process image. Refer to chapter 4.3 for further information about the status of the fieldbus inputs.

4. Status of the fieldbus outputs

4 bytes are available for the status of the fieldbus outputs. Each bit represents the status of a fieldbus output (FIELDBUS PROBE) used in the MSC program. Max. 32 fieldbus output bits can be used.

5. Status of the MSC safety outputs

All safety outputs are combined in up to 4 bytes, depending on the firmware version of the fieldbus module, see Table 2. The dual-channel safety outputs are transmitted as one bit via the fieldbus.

Fieldbus module firmware version	Size of safety output structure
< 2.0	up to two bytes
≥ 2.0	4 bytes

Table 2: Safety output structure

FW ≥ 2.0	The base unit MSC-CB can process only 16 bits at the safety outputs, which is why only the first two bytes of the safety output structure are used.
FW < 2.0	The base unit MSC-CB-S can process up to 32 bits at the safety outputs, but only the first 16 bits of the safety output structure can be transferred due to the limitation of the fieldbus module.

Depending on the type of the respectively installed modules, the position of the safety outputs varies in the following sequence: MSC-CB/MS-CB-S, FI8FO2, AC-FO2, AC-FO4, AZ-FO4, AZ-FO408, AH-FO4S08, FI8FO4S. If several modules of the same type are installed, the order corresponds to the node number.

4.2. Acyclic process image / diagnostics

For each MSC input and MSC safety output, a diagnostic code may be available that contains detailed information about the actual status.

A diagnostic element consists of an index for the input/safety output and the related diagnostic code.

If there is no diagnostic information for the input/safety output, the diagnostic code is OK.

FW ≥ 2.0	The diagnostic area in the output structure comprises 64 bytes, and the first 23 diagnostic elements are therefore sent via the fieldbus simultaneously.
FW < 2.0	The diagnostic area in the output structure comprises two bytes, which is why only one diagnostic element can be sent. With several diagnostic elements, the relative values change every 500 ms.
FW < 2.0	Each information set: › Input status › Input diagnostics › Fieldbus input status › Probe state › Safety output status › Safety output diagnostics can be activated/deactivated to control the information and therefore the number of bytes sent to the fieldbus.

If there is a problem on the input/safety output, the system sends two bytes to the fieldbus with:

- › The index for the related input/safety output
- › The relative diagnostic code

4.2.1. "I/O index" field

This field indicates the number of the input/safety output with the diagnostic code that is not OK. The range of the I/O index depends on the base unit used. The possible values are shown in *Table 3*.

Signal type	I/O index	
	MSC-CB	MSC-CB-S
Input	1–128	1–128
Output	192–255	1–32

Table 3: "I/O index" field

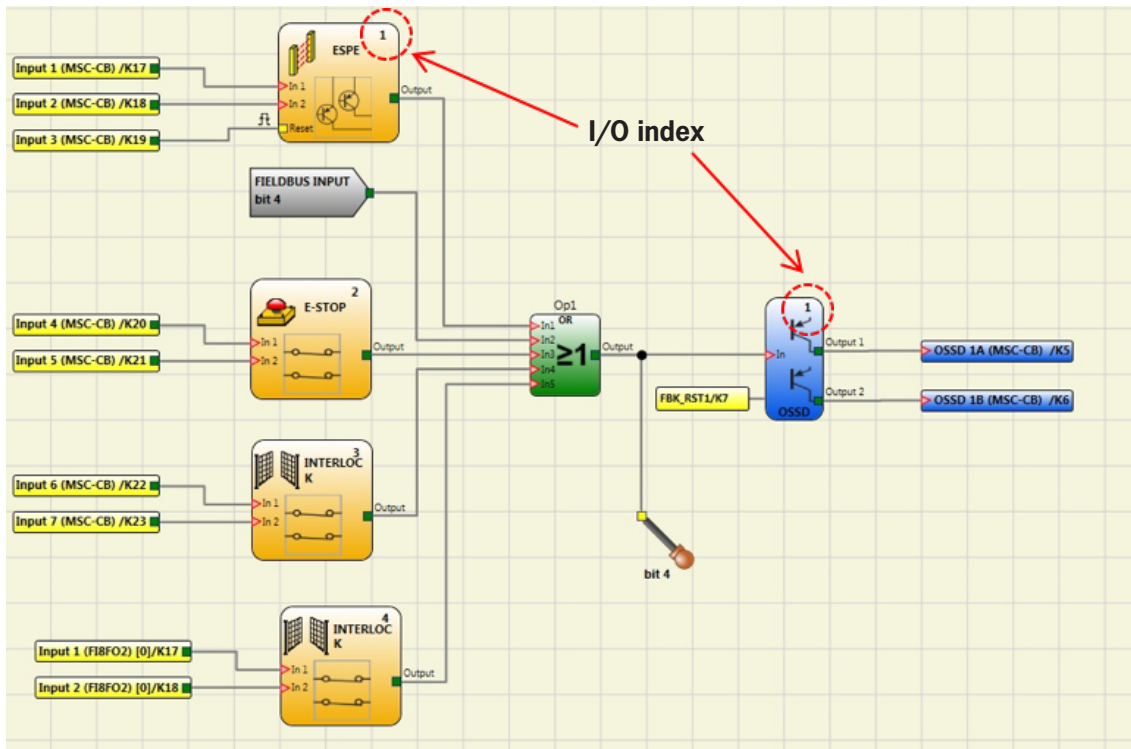

Fig. 3: I/O index

4.2.2. “Diagnostic code” field

The diagnostics for the I/O are displayed in the “Diagnostic code” field. Possible values for this value are shown in *Table 4* and *Table 5*.

Input diagnostics		
128 (0x80)	Input diagnostics OK	-
1	Not moved from zero	Both contacts must switch to the de-energized state
2	Simultaneity failed	Both contacts must switch to the other state simultaneously
3	Simultaneity failed hand1	Incorrect connection of switch 1 for two-hand operation
4	Simultaneity failed hand2	Incorrect connection of switch 2 for two-hand operation
7	Switch inconsistent	Not more than one input is allowed to be set for the selector switch
8	Switch disconnected	At least one input must be set for the selector switch
10	OUT_TEST error	OUT_TEST diagnostics present on this input
11	Second input KO	Redundancy check on the input failed
13	Output connected to other inputs	Test output connected to wrong input
14	Output OK but input connected to 24VDC	Input short-circuited
15	Short circuit between photocell test and photocell input	Response time of the light barrier too short
16	No response from photocell	The test signal on the transmitter for the light barrier is not visible at the receiver
17	Short circuit between photocells	The test signal is present on two different light barriers
18	MAT disconnected	Mat connected incorrectly
19	Output inconsistent with feedback	The test signal on the input is present on more than one OUT_TEST
20	Connection incorrect	The test signal is present on more than one input
21	Output stuck	The test signal on the input does not correspond to that on the output OUT_TEST
22	Second OUT_TEST KO	Redundancy check on the OUT_TEST failed
23	SPM proximity missing	Proximity switch not fitted / proximity switch does not work
24	SPM encoder missing	Encoder not fitted / encoder not supplied
25	SPM encoder proximity missing	Device connected not correct
26	SPM proximity1 proximity2 missing	Both proximity switches must be connected
27	SPM encoder1 encoder2 missing	Both encoders must be connected
28	SPM frequency congruence error	Frequency congruence error
29	SPM encoder supply missing	Encoder not supplied correctly
30	SPM encoder fault	Encoder error
133 (0x85) ¹⁾	TWO-HAND simultaneity failed	Two-hand control simultaneity infringed
134 (0x86) ¹⁾	Not started	Start check failed
137 (0x89) ¹⁾	Waiting for restart	The input has been reset manually and not restarted

¹⁾ The diagnostic codes 133, 134 and 137 do not cause a visual error message on the LED on the MSC system.

Table 4: “Input diagnostics” field

OSSD diagnostics		
0	OSSD DIAGNOSTICS OK	OSSD diagnostics OK
1	ENABLE MISSING	No enable
2	WAITING FOR RESTART OSSD	Waiting for restart OSSD
3	FEEDBACK K1/K2 MISSING	No feedback K1/K2
4	WAITING FOR OTHER MICRO	Redundancy check on OSSD failed
5	OSSD power supply missing	No OSSD supply
6	Exceeded maximum time restart	Time for restart exceeded
7	External feedback K1 K2 not congruent CAT 2	Feedback error on using AZ-F04/AZ-F0408 in CAT2 configuration
8	Waiting for external feedback K1 K2	Waiting for feedback
9	OSSD output overload	Overload at OSSD output
10	OSSD with load set to 24V	OSSD with set load of 24 V

Table 5: “OSSD diagnostics” field

4.3. Input structure

Up to 4 bytes can be read by the higher level control system via the fieldbus module and used as non-safe inputs in the MSC program.

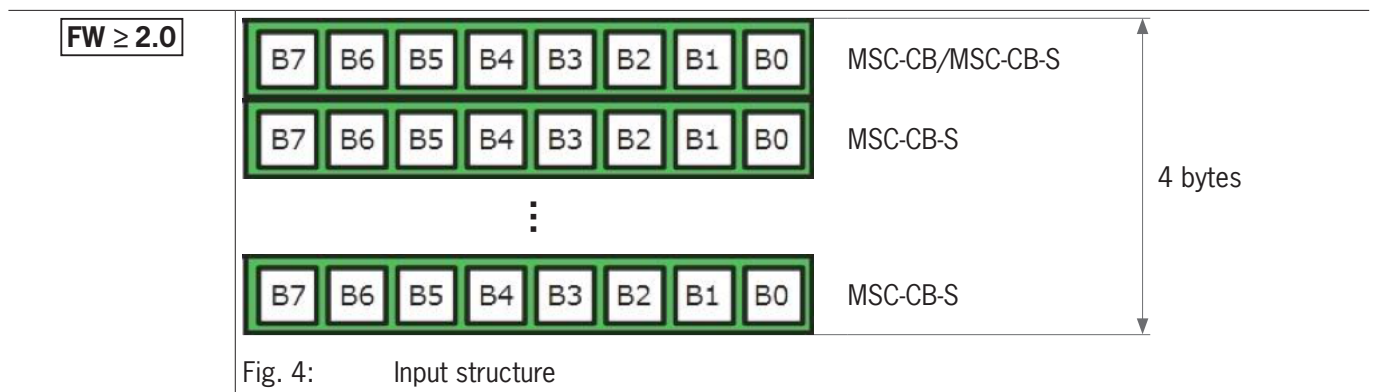

It is possible to read up to 32 fieldbus inputs, depending on the firmware version of the fieldbus module. For further information refer to Table 6:

Fieldbus module firmware version	Size of input structure
< 2.0	1 byte (8 fieldbus inputs)
≥ 2.0	4 byte (32 fieldbus inputs)

Table 6: Fieldbus input structure

FW ≥ 2.0	The base unit MSC-CB can process only 8 fieldbus inputs, which is why only the first byte in the input structure is used.
FW < 2.0	The base unit MSC-CB-S can process up to 32 fieldbus inputs, but only the first byte is transferred due to the limitation of the input structure.

4.4. Cyclic / acyclic process image

FW ≥ 2.0

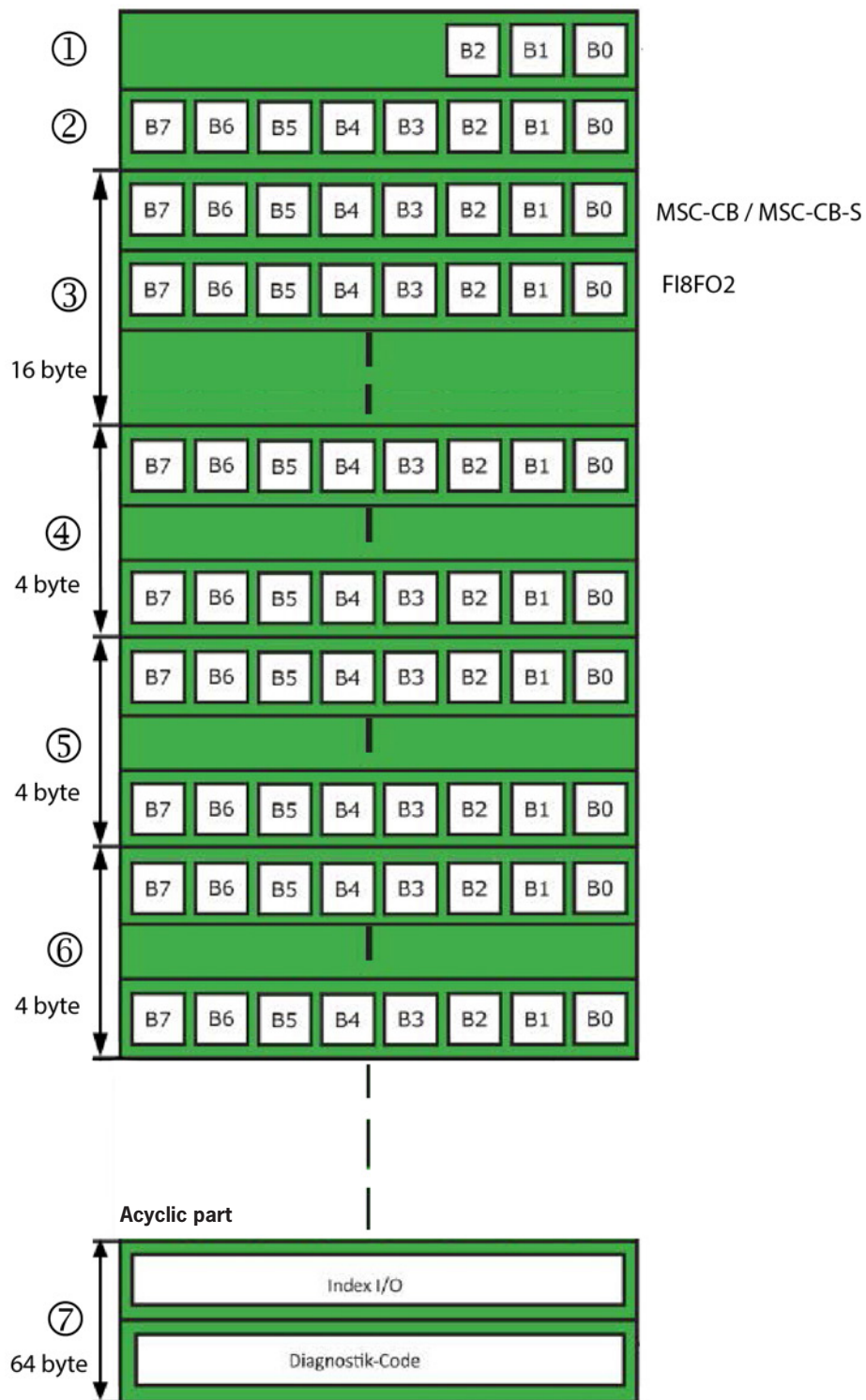

Fig. 5: Cyclic / acyclic process image

Key for Fig. 5: Cyclic / acyclic process image

①	System status (1 byte)	<p>B0 = 0: MSC offline B0 = 1: MSC online B1 = 1: Diagnostics available B1 = 0: No diagnostics available B2 = 1: Error present B2 = 0: No error</p>
②	Reserved area (1 byte)	
③	Status of the MSC inputs (16 bytes)	<p>Each module has a number of bits to suit the number of physical inputs. The following applies:</p> <ul style="list-style-type: none"> ▸ The modules MSC-CB/MS-CB-S, F18, F18FO2, F18FO4S, SPM0, SPM1 and SPM2 occupy 1 byte. ▸ The modules F116 and FM4 occupy 2 bytes. ▸ The position of the bytes corresponds to the sequence: MSC-CB/MS-CB-S, F18FO2, F116, F18, FM4, SPM2, SPM1, SPM0, F18FO4S. ▸ If there are 2 modules of the same type, the order is based on the node number.
④	Copy of the fieldbus inputs (4 byte)	Used for feedback to the PLC
⑤	Status of the fieldbus outputs (FIELDBUS PROBE) (4 bytes)	Each bit represents the status of a fieldbus output in the project plan. Max. 32 fieldbus output bits can be used.
⑥	Status of the MSC safety outputs (OSSD / relay) (4 bytes)	Each bit represents the status of an OSSD/relay. The position of the bits corresponds to the sequence: MSC-CB/MS-CB-S, F18FO2, AC-F02, AC-F04, AZ-F04, AZ-F0408, AH-F04S08, F18FO4S.
⑦	Diagnostics (64 bytes)	<p>Each input or safety output function block is linked to the diagnostic code. The system exports 2 bytes on the fieldbus for each diagnostic element:</p> <ul style="list-style-type: none"> ▸ The index for the related I/O ▸ The diagnostic code

FW < 2.0

The output structure comprises:

- one status byte,
- a variable number of bytes for the status of the inputs (max. 16 bytes),
- one byte for the feedback of the fieldbus inputs,
- two bytes for the status of the fieldbus outputs,
- a variable number of bytes for the status of the safe outputs (max. 2 bytes),
- two bytes for diagnostics.



NOTICE

If the MSC system uses a fieldbus module, the EUCHNER Safety Designer report contains a table with the I/O index for all inputs, the fieldbus input, the fieldbus output (PROBE) and the safety outputs in the circuit diagram.

FW < 2.0

The scope of the sub-section "Inputs State" and the sub-section for the OSSD/relay status depends on the hardware configuration in the MSC system. The sub-section for the OSSD/relay status is limited to 2 bytes here. The reserved areas are not transmitted, and the Diagnostics sub-section comprises only 2 bytes.

The input and output structures can be graphically depicted in the Bus Configurator – User Interface, see Fig. 6.

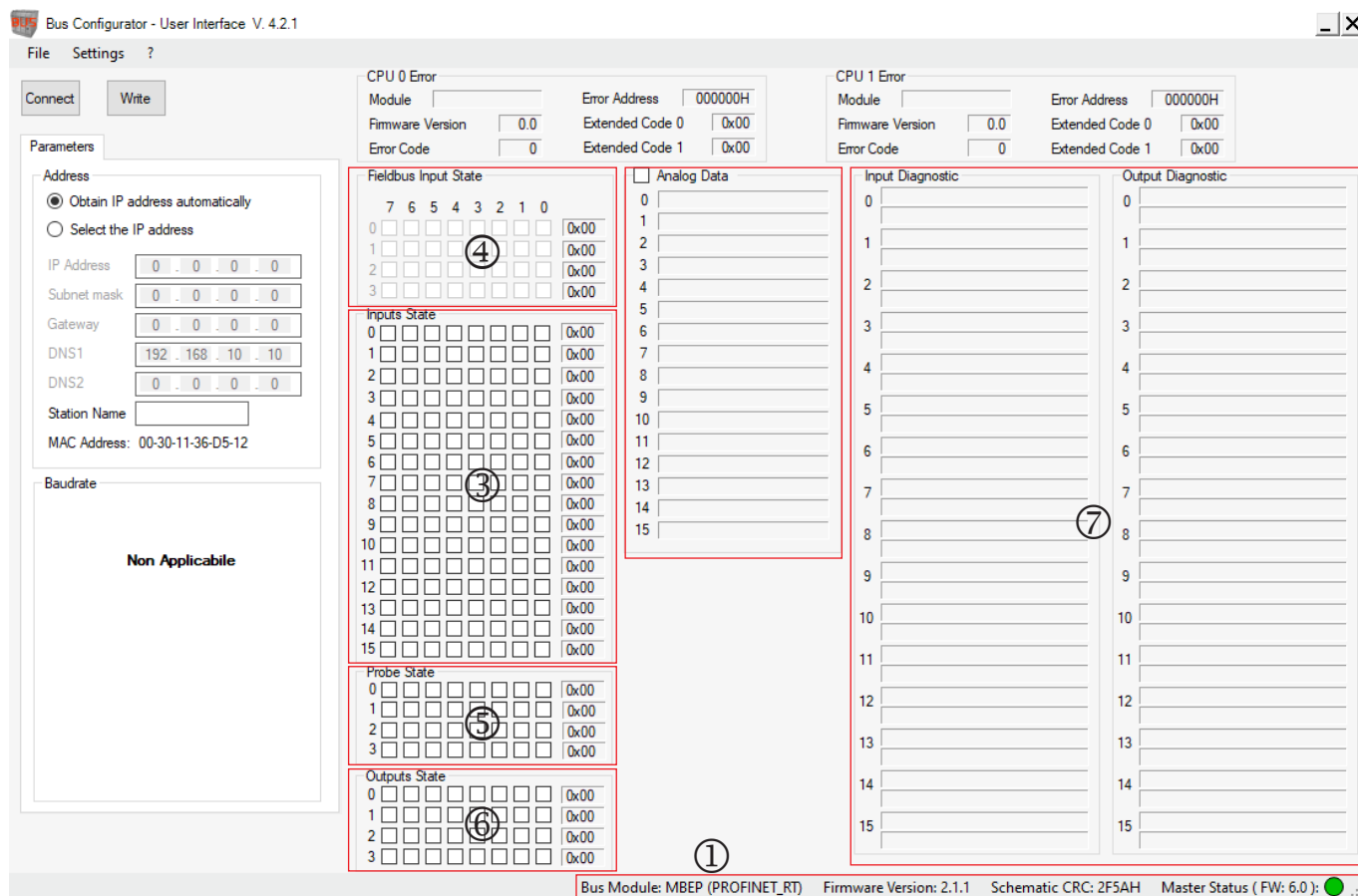

Fig. 6: Bus Configurator – User Interface, input and output structures

Key for Fig. 6: Bus Configurator – User Interface, input and output structures, see key for Fig. 5: Cyclic / acyclic process image

4.5. Configuration of the input and output structure – backward compatibility

FW < 2.0

The input and output structure can be configured using the software application Bus Configurator – User Interface. Backward compatibility must be set under Settings -> Activation for this purpose.



Important!

The compatibility mode functions only in combination with a base unit MSC-CB or with a fieldbus module with a firmware version < 2.0.

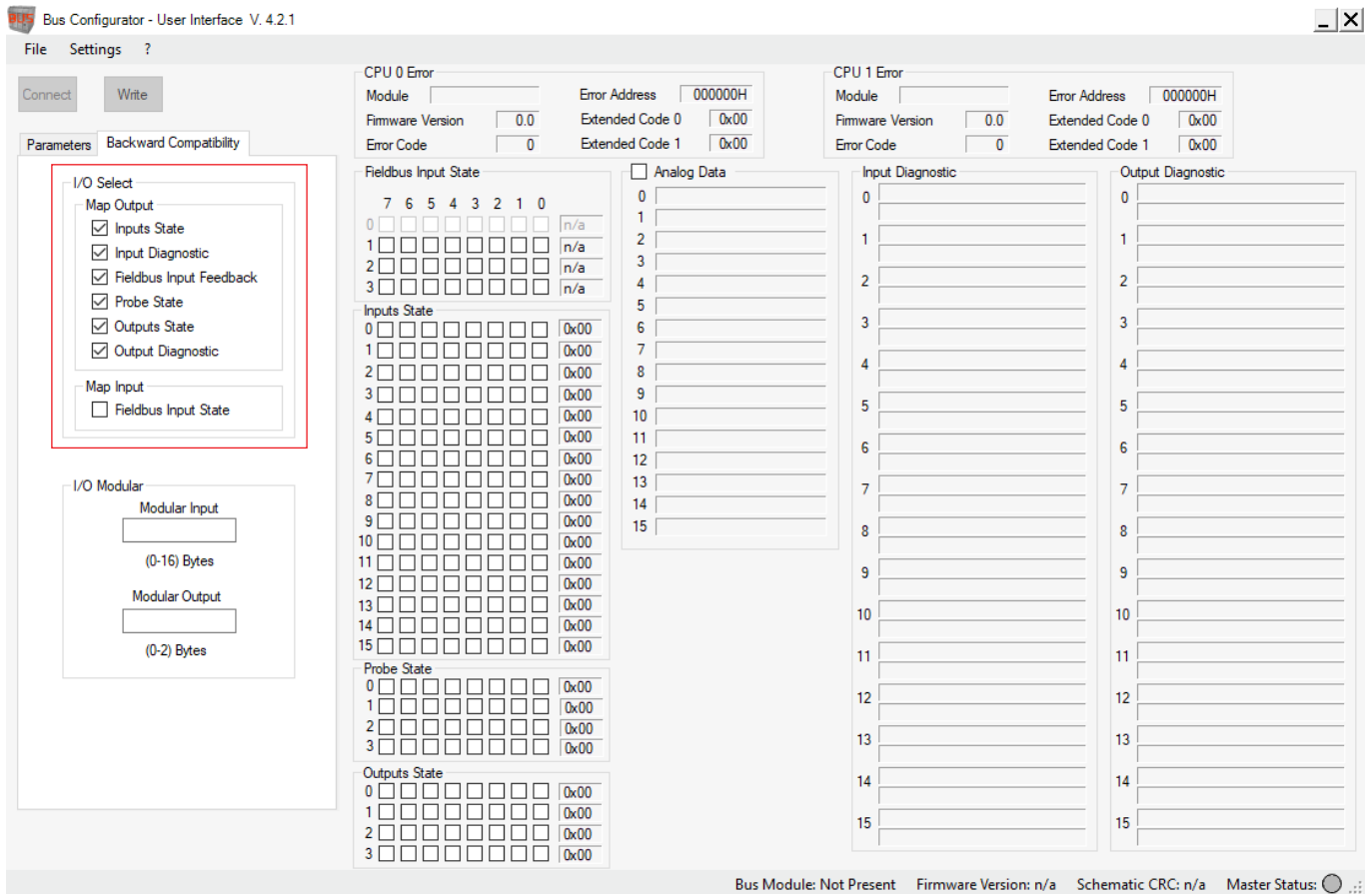

Fig. 7: Bus Configurator – User Interface, compatibility mode

FW < 2.0

The “Backward Compatibility” tab appears after the compatibility mode is set, see Fig. 7. The “I/O Select” area can be used to define the sub-sections to be exported on the fieldbus. In this way, the size of the structure and therefore the usage of the internal memory in the PLC can be defined.

The number of bytes exported to the fieldbus from the “Inputs State” and “Outputs State” group can be specified in the “I/O Modular” area.



Important!

If zero is entered in the “Modular Input” and “Modular Output” boxes, the size of the “Inputs State” and “Outputs State” group depends directly on the number of inputs and outputs in the program loaded into the base unit MSC-CB.

4.6. Input status of the SPM modules

All modules occupy 4 bits, i.e. bits 0 to 3 or bits 4 to 7 in the "Inputs State" area. The contents of the bits are given in the tables below.



NOTICE

Check the information in this table in the operating instructions (in the "Function blocks for speed monitoring" chapter).

STANDSTILL CONTROL			
Encoder / encoder + proximity switch		Proximity switch	
Code	Meaning	Code	Meaning
0	> Standstill + counterclockwise (CCW)	0	> Standstill
2	> Standstill + clockwise (CW)	3	< Standstill
3	< Standstill + counterclockwise (CCW)		
5	< Standstill + clockwise (CW)		

Table 7: Standstill control

WINDOW SPEED CONTROL			
Encoder / encoder + proximity switch		Proximity switch	
Code	Meaning	Code	Meaning
0	Out of range + counterclockwise (CCW)	0	Out of range
1	Within range + counterclockwise (CCW)	1	Within range
2	Out of range + clockwise (CW)		
3	Within range + clockwise (CW)		

Table 8: Window speed control

SPEED CONTROL			
Encoder / encoder + proximity switch		Proximity switch	
Code	Meaning	Code	Meaning
0	> Speed limit + counterclockwise (CCW)	0	> Speed limit
1	< Speed limit + counterclockwise (CCW)	1	< Speed limit
2	> Speed limit + clockwise (CW)		
3	< Speed limit + clockwise (CW)		

Table 9: Speed control

STANDSTILL AND SPEED CONTROL			
Encoder / encoder + proximity switch		Proximity switch	
Code	Meaning	Code	Meaning
0	> Standstill > speed limit + counterclockwise (CCW)	0	> Standstill > speed limit
1	> Standstill < speed limit + counterclockwise (CCW)	1	> Standstill < speed limit
2	> Standstill > speed limit + clockwise (CW)	4	< Standstill < speed limit
3	> Standstill < speed limit + clockwise (CW)		
4	< Standstill < speed limit + counterclockwise (CCW)		
6	< Standstill < speed limit + clockwise (CW)		

Table 10: Standstill and speed control

5. Signals and pin assignment

MEANING	LED					
	ON GREEN	RUN GREEN	IN FAIL RED	EXT FAIL RED	LED1 RED/GREEN	LED2 RED/GREEN
Switching on – booting	ON	ON	ON	ON	ON	ON
Waiting for configuration from MSC-CB	ON	OFF	OFF	OFF	OFF	OFF
Configuration received from MSC-CB	ON	ON	OFF	OFF	See tables for the individual modules	

Table 11: Dynamic indication

MEANING	FAULT DIAGNOSTICS					
	LED					
	ON GREEN	RUN GREEN	IN FAIL RED	EXT FAIL RED	LED1 RED/GREEN	LED2 RED/GREEN
Internal microcontroller fault	ON	OFF	2 flashes *	OFF	See tables for the modules	
Internal printed circuit board fault	ON	OFF	3 flashes *	OFF		
Configuration error	ON	OFF	5 flashes *	OFF		
BUS communication error	ON	OFF	5 flashes *	OFF		
BUS communication interrupted	ON	OFF	ON	OFF		
Identical module detected	ON	OFF	5 flashes *	5 flashes		

* The sequence of the LED flashes is as follows: ON for 300 ms and OFF for 400 ms with an interval of 1 s between two sequences.

Table 12: Fault diagnostics

5.1. Module CANopen CE-CO

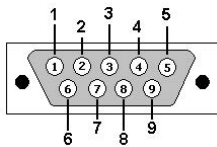

DB9 male plug
(view on front)



Pin	SIGNAL
1	-
2	CAN_L
3	CAN_GND
4	-
5	CAN_SHIELD
6	-
7	CAN_H
8	-
9	-
Housing	CAN_SHIELD

OPR LED		
STATUS	INDICATION	DESCRIPTION
GREEN	OPERATIONAL	OPERATIONAL state
GREEN flashing slowly	PRE-OPERATIONAL	PRE-OPERATIONAL state
GREEN one flash	STOPPED	STOPPED state
GREEN flashing quickly	Autobaud	Baud rate detection
RED	EXCEPTION	EXCEPTION state

ERR LED		
STATUS	INDICATION	DESCRIPTION
OFF	-	Normal operation
RED one flash	Warning level	A bus error counter has reached the warning level
RED flashing quickly	LSS	LSS operation ready
RED two flashes	Event Control	Node guarding (NMT master or slave) or heartbeat (user) detected
RED	Lack of BUS	BUS is not working

5.2. Module DeviceNet CE-DN

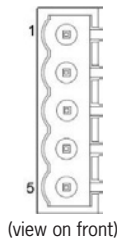

Pin	SIGNAL	DESCRIPTION
1	V-	Power supply
2	CAN_L	CAN bus cable (LOW)
3	SHIELD	Shielding
4	CAN_H	CAN bus cable (HIGH)
5	V+	Power supply

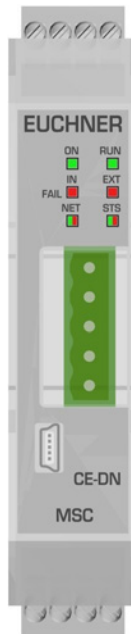

NET LED		
STATUS	INDICATION	DESCRIPTION
GREEN	On-line connected	One or more connections made
GREEN flashing (1 Hz)	On-line non connected	No connections made
RED	Critical connection error	CE-DN communication not possible
RED flashing (1 Hz)	Time-out of 1 or more connection	One or more I/O devices have timed out
GREEN/RED alternately	TEST	CE-DN check in progress

STS LED		
STATUS	INDICATION	DESCRIPTION
GREEN	-	Normal operation
GREEN flashing (1 Hz)	Pending	Configuration incomplete, CE-DN waiting for activation
RED	Fatal error	One or more unrecoverable errors detected
RED flashing (1 Hz)	Error	One or more recoverable errors detected
GREEN/RED alternately	TEST	CE-DN check in progress

5.3. Module PROFIBUS CE-PR

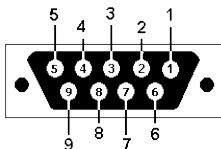

DB9 female plug
(view on front)



Pin	SIGNAL	DESCRIPTION
1	-	
2	-	
3	B-line	Positive RS485 RxD/TxD
4	RTS	Request to send
5	GND bus	0 VDC (isolated)
6	5 V	+5 VDC (isolated/short-circuit-proof)
7	-	-
8	A-line	Negative RS485 RxD/TxD
9	-	-
Housing	Shielding	Connected internally to protective earth (acc. to PROFIBUS standard)

MODE LED		
STATUS	INDICATION	DESCRIPTION
GREEN	On-line	Data exchange
GREEN flashing	On-line	AVAILABLE
RED one flash	Parameterization error	See IEC 61158-6
RED two flashes	PROFIBUS configuration error	Configuration data for MASTER or CE-PR incorrect

STS LED		
STATUS	INDICATION	DESCRIPTION
OFF	CE-PR not initialized	SETUP STATE or NW_INIT
GREEN	Initialized	End of initialization NW_INIT
GREEN flashing	Initialized with diagnostic active	EXTENDED DIAGNOSTIC bit set
RED	Exception error	EXCEPTION STATE

5.4. Module EtherCAT CE-EC

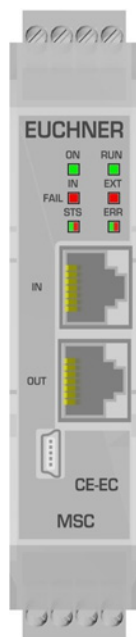

STS LED		
STATUS	INDICATION	DESCRIPTION
OFF	INIT	INITIALIZATION or no voltage
GREEN	OPERATIONAL	OPERATIONAL status
GREEN flashing	PRE-OPERATIONAL	PRE-OPERATIONAL status
GREEN one flash	SAFE-OPERATIONAL	SAFE-OPERATIONAL status
RED	Fatal Event	System inhibited
flashing	BOOT	BOOT status

ERR LED		
STATUS	INDICATION	DESCRIPTION
OFF	No error	No error or no voltage
RED flashing	Configuration not valid	Status change requested by master not possible
RED one flash	Unsolicited state change	Use of the slave changed the module status
RED two flashes	Watchdog timeout	Watchdog timeout in the Sync Manager
RED	Controller fault	Bus module in EXCEPTION state
flashing	Booting error	Firmware download not successful, for example

5.5. Module EtherNet/IP CE-EI

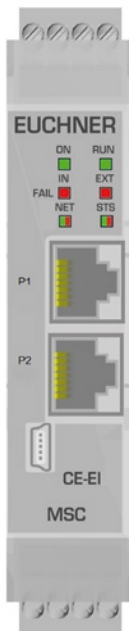

NET LED	
STATUS	INDICATION / DESCRIPTION
OFF	No voltage or no IP address
GREEN	Online, connected
GREEN flashing	Online, not connected
RED	Duplicate IP address
RED flashing	Connection timeout

STS LED		
STATUS	INDICATION	DESCRIPTION
OFF	No power	-
Green	RUN state	-
GREEN flashing	Not configured	-
RED	Fatal error	One or more unrecoverable errors detected
RED flashing	Error	One or more recoverable errors detected



NOTICE

- › The CE-EI module is supplied with 2x RJ45 ports. This module is a dual-port switch.
- › The CE-EI module supports both line and ring topologies (DLR, Device Level Ring).

5.6. Module PROFINET CE-PN

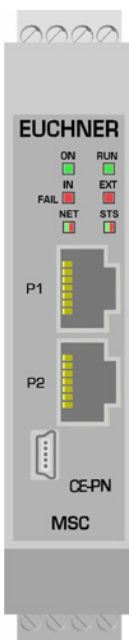

NET LED		
STATUS	INDICATION	DESCRIPTION
OFF	Offline	No voltage or connection to I/O control system
GREEN	Online (Run)	Connection to I/O control system established or I/O control system in RUN state
GREEN one flash	Online (Stop)	Connection to I/O control system established or I/O control system in STOP state or IRT synchronization not complete
GREEN flashing	Blink	Identification of the network node
RED	Fatal event	Severe internal error (in combination with RED STS)
RED one flash	Station name error	Station name not configured
RED two flashes	IP address error	IP address not configured
RED three flashes	Configuration error	Error during identification

STS LED		
STATUS	INDICATION	DESCRIPTION
OFF	Not initialized	-
GREEN	Normal operation	-
GREEN one flash	Diagnostic event	-
RED	Exception / Fatal event	Module in the EXCEPTION state / severe internal error (in combination with RED NET)

5.7. Module Modbus TCP/IP CE-MT

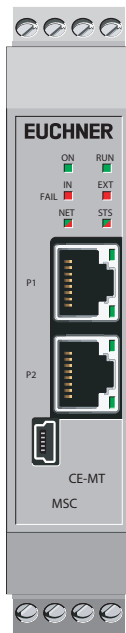

NET LED	
STATUS	INDICATION / DESCRIPTION
OFF	No voltage or no IP address
GREEN	Module in the active process or on standby
GREEN flashing	Waiting for connection
RED	Duplicate IP address or unrecoverable error
RED flashing	Timeout for active process

STS LED		
STATUS	INDICATION	DESCRIPTION
OFF	No power	-
Green	Normal operation	-
RED	Exception / Fatal error	Module in the EXCEPTION state / severe internal error
RED flashing	Error	One or more recoverable errors detected

5.8. Module Modbus RTU CE-MR

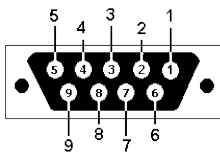

DB9 female plug
(view on front)



Pin	DIRECTION	SIGNAL	DESCRIPTION
1	-	GND	Power supply 0 V DC
2	OUT	5 V	Power supply 5 V DC
3	IN	PMC	For RS-232 connect to pin 2. Not connected for RS-485.
4	-	-	-
5	Bidirectional	B-line	RS-485 B-line
6	-	-	-
7	IN	Rx	Receive RS-232 data
8	OUT	Tx	Send RS-232 data
9	Bidirectional	A-line	RS-485 A-line
Housing	-	PE	Earth conductor

COM LED		
STATUS	INDICATION	DESCRIPTION
OFF	No power or no data exchange	
YELLOW	Frame Reception or Transmission	Data exchange
RED	Fatal Error	One or more unrecoverable errors detected

STS LED		
STATUS	INDICATION	DESCRIPTION
OFF	Initializing or no power	
GREEN	Module initialized	
RED	Fatal Error	One or more unrecoverable errors detected
RED one flash	Communication fault or configuration error	<ul style="list-style-type: none"> Invalid setting in network configuration or Setting in the network configuration has been changed during operation
RED two flashes	Application diagnostics available	

5.9. Module PROFINET CE-US



CONNECT LED		
STATUS	INDICATION	DESCRIPTION
GREEN	USB connected	Module connected to PC via USB
OFF	USB not connected	Module not connected

6. Example diagnostics

6.1. Example 1

In the example in Fig. 8, input 1 (connected to module MSC-CB) is tested using the test signal MSC-CB-Test1. During the wiring work, 24 VDC is connected to input 1 instead of the test signal MSC-CB-Test1.

- The “I/O index” and “Diagnostic code” fields assume the following values:
1 - 20 to display the diagnostic element at input 1 of the MSC-CB module (connection error).

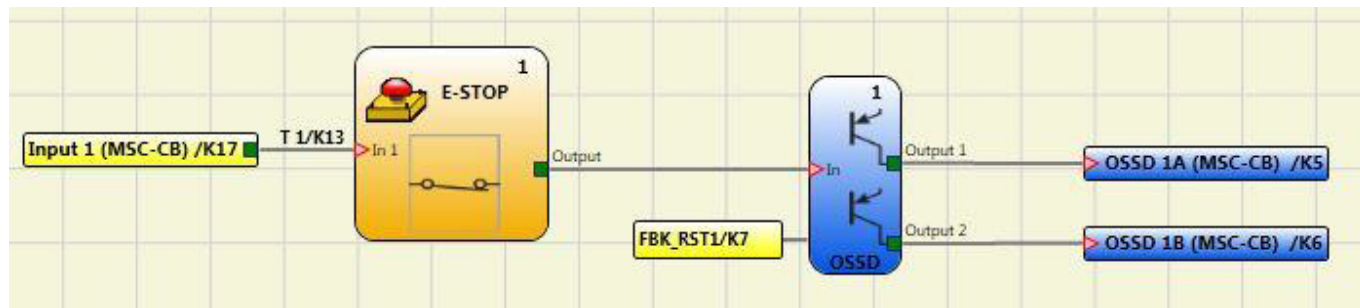

Fig. 8: Example diagnostics 1

6.2. Example 2



NOTICE

The I/O index corresponds to the logical block and not the terminal number on the module MSC-CB.

In Fig. 9, the two-hand switching element connected to the terminals “Input1” and “Input2” corresponds to I/O index no. 1 and the emergency stop button connected to the terminals “Input3” and “Input4” corresponds to I/O index no. 2.

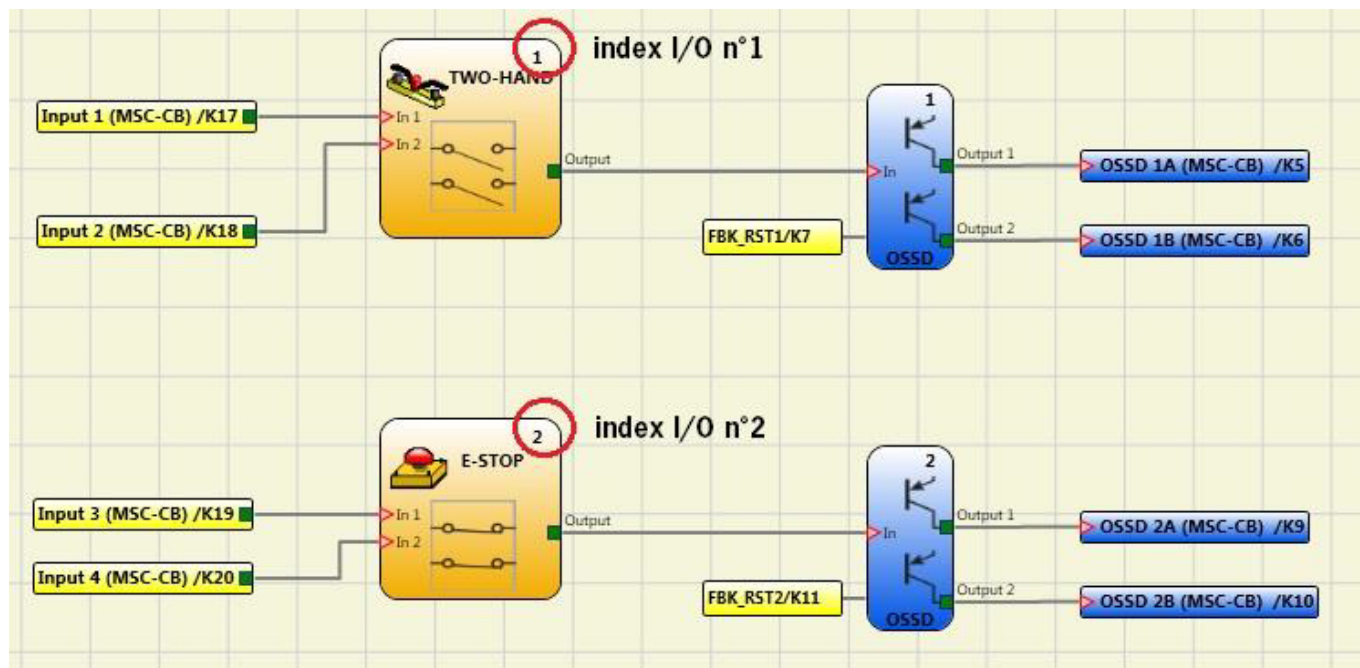

Fig. 9: Example diagnostics 2

6.3. Example 3

The example in Fig. 10 is comparable with example 1, except in this case “Input1” is connected to module FI16 and tested using the test signal FI16-Test1.

During the wiring work, 24 VDC is connected to “Input1” instead of the FI16-Test1 test signal.

“Input1” has the diagnostic code 20 (incorrect connection).

- › The “I/O index” and “Diagnostic code” fields assume the following values:
 1 - 20 to display the diagnostic element at “Input1” of module FI16.

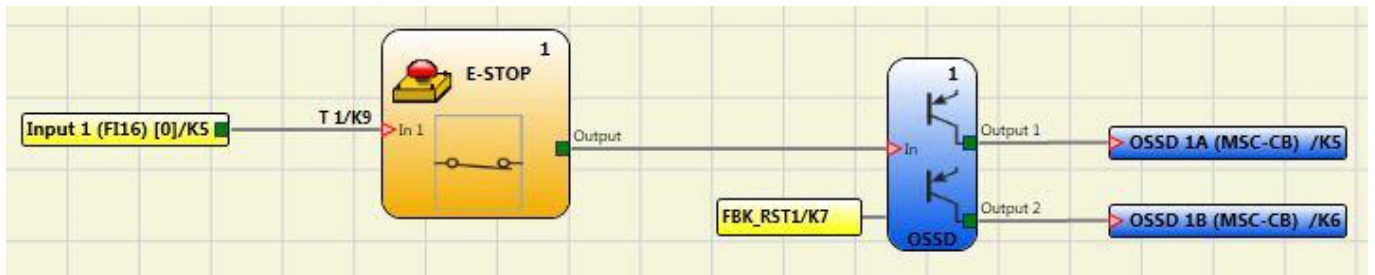

Fig. 10: Example diagnostics 3

In this example in Fig. 11, the manual reset function on OSSD 1 is activated.

The pushbutton connected to Input1 is pressed without sending a reset command.

- › The “I/O index” and “Diagnostic code” fields assume the following values: 192 - 2
- › To indicate the diagnostics on OSSD 1A/1B (Table 3: 192 = first output).
- › To indicate the diagnostic code (Table 5: 2 = waiting for restart of OSSD).

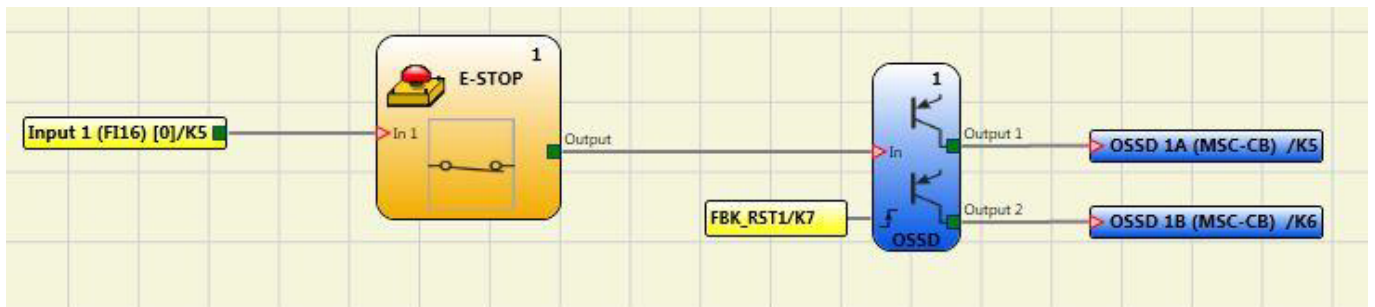

Fig. 11: Example diagnostics 3 with manual reset function

7. “Bus Configurator” user interface

The bus module is configured via the USB Mini-B port on the front plate and the “BUS CONFIGURATOR” software installed (available at www.euchner.com).

This software supports the configuration of the MSC system using a PC, as well as the indication of the data transmitted via the bus (via the connection of a bus module to the USB port).

The parameters to be configured include the address of the module in the fieldbus network, and possibly the data transfer speed.

FW < 2.0	Additionally, the data sets transferring the parameters, the modular I/Os and the fieldbus input can be set.
--------------------	--

The address space range is dependent on the type of fieldbus installed.

7.1. Graphic user interface



NOTICE

The module must be configured with the system switched off (outputs OFF).

The module configuration can be queried at any time as long as the module is in operation.

The fieldbus module is configured as follows:

1. Connect module to the power supply (+24 VDC ± 20 %) via the terminal block.
2. Connect USB cable to the PC and the fieldbus module.
3. On the desktop, click the “**Bus Configurator – User Interface**” icon.

The following configuration window appears (Fig. 12):

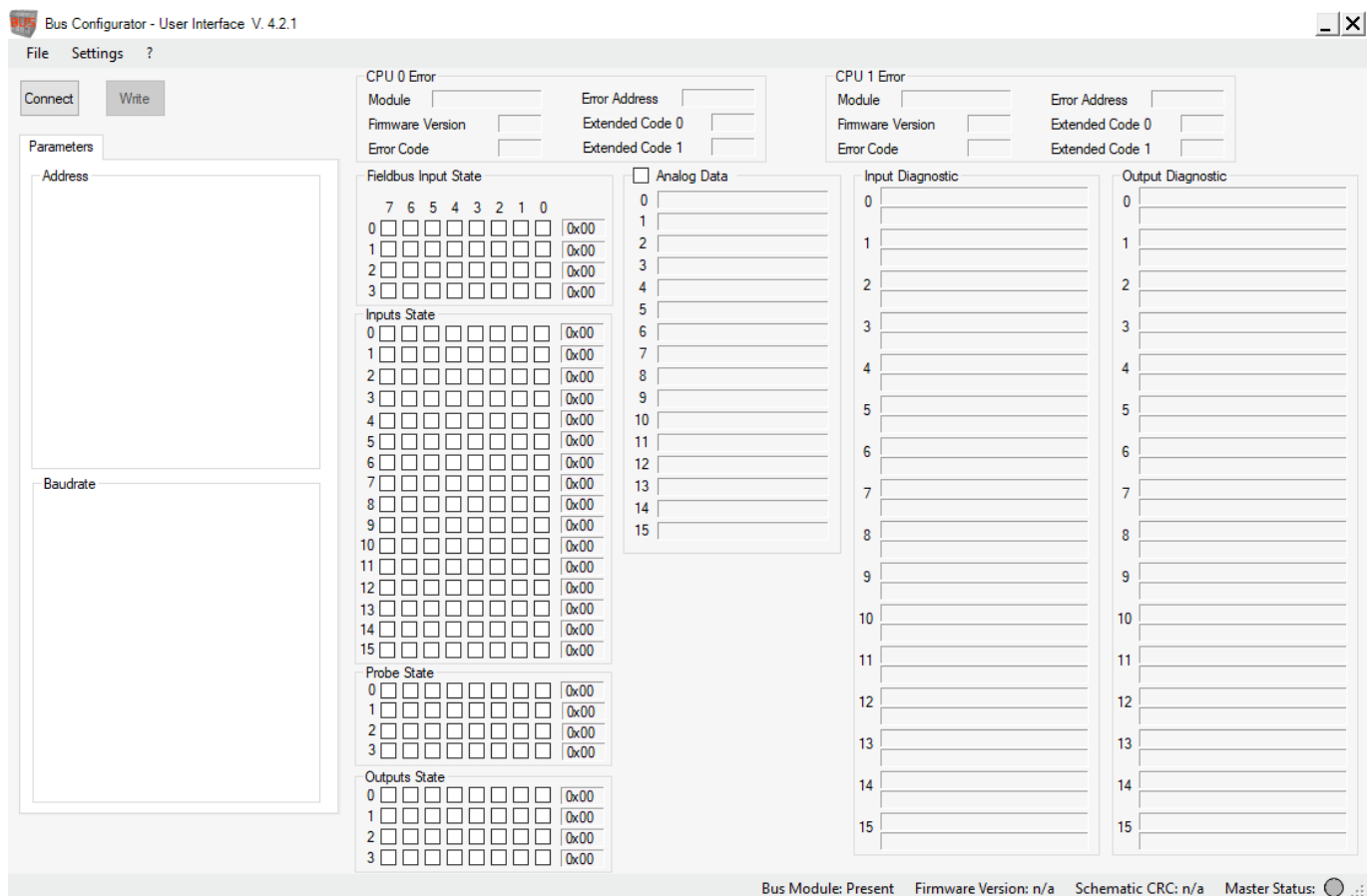

Fig. 12: Bus Configurator – User Interface, configuring fieldbus module

4. Click the **CONNECT** button.

The program detects that a fieldbus module is connected (Fig. 13). The status bar shows the fieldbus model ①, the firmware version of the fieldbus module ②, the schematic CRC ③ and the status and firmware version of the base unit ④:

- Gray: fieldbus module not connected
- Orange: fieldbus module communicating with the Bus Configurator
- Green: base unit active (RUN)
- Red: base unit not active (e.g. communication with Safety Designer)

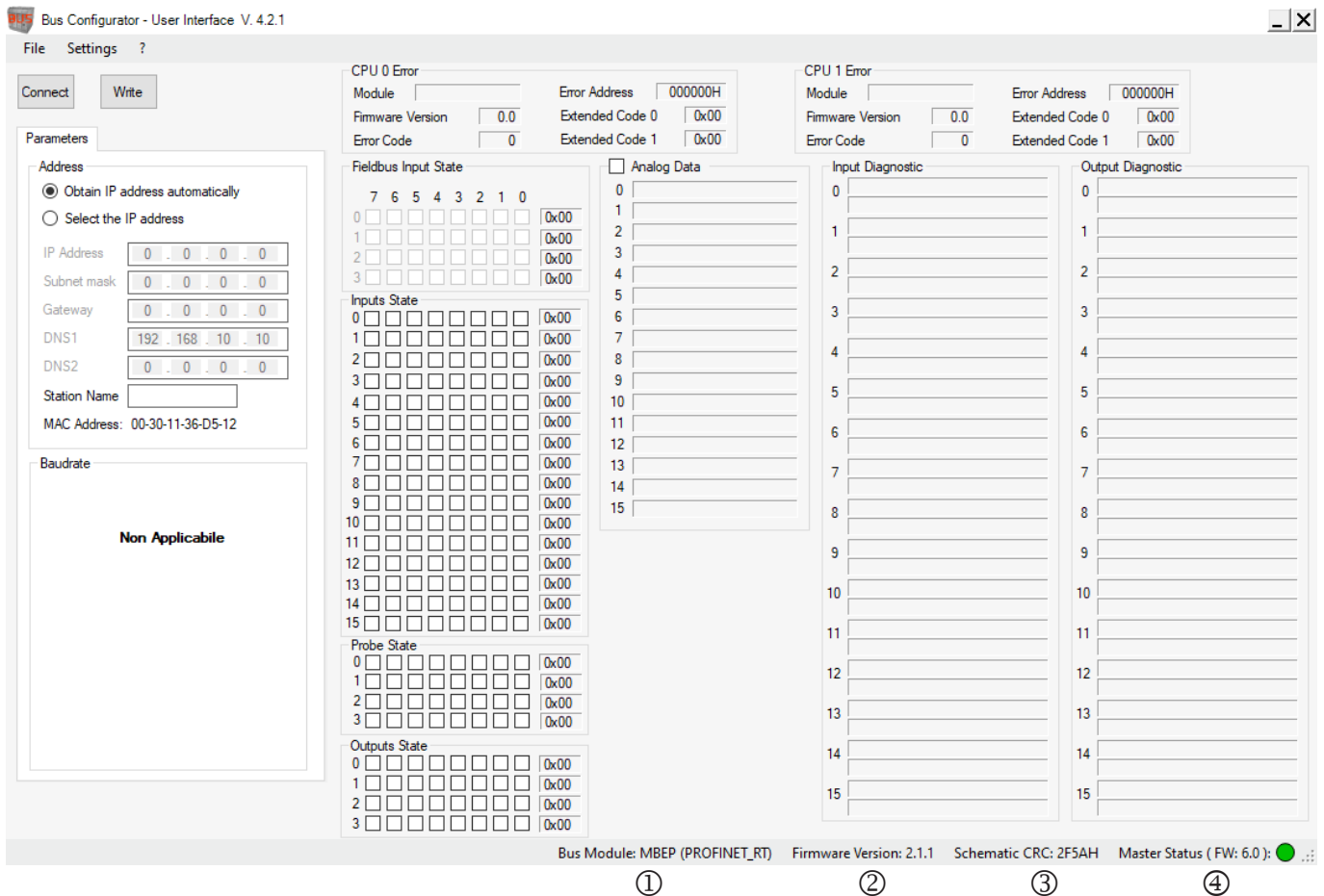

Fig. 13: Bus Configurator – User Interface, Bus Configurator information

Once the connection to the fieldbus module has been established and the fieldbus module has been detected, the parameters can be configured (see Fig. 13). Transfer the configuration data to the module by clicking the **Write** button.

	ADDRESS	BAUDRATE	DATA SETS
CE-CO	127	AUTO	Input status Fieldbus input status Fieldbus output status (Probe) Output status
CE-DN	63	AUTO	Input status Fieldbus input status Fieldbus output status (Probe) Output status
CE-PR	126	NZ	Input status Fieldbus input status Fieldbus output status (Probe) Output status
CE-EC	0	NZ	Input status Fieldbus input status Fieldbus output status (Probe) Output status
CE-EI	0.0.0.0	AUTO	Input status Fieldbus input status Probe state Output status
CE-PN	0.0.0.0	NZ	Input status Fieldbus input status Fieldbus output status (Probe) Output status

Table 13: Default values

As soon as the fieldbus module receives the data, the Configurator changes to state monitoring. The status of the inputs and outputs and the diagnostics are shown in *Fig. 14* and *Fig. 15*. The first 16 diagnostic elements are displayed. If more than 16 diagnostic elements are available, the additional diagnostic elements are displayed after the preceding ones are deleted.

Fieldbus Input State									
	7	6	5	4	3	2	1	0	
0	<input type="checkbox"/>	<input type="checkbox"/>	<input type="checkbox"/>	<input type="checkbox"/>	<input type="checkbox"/>	<input type="checkbox"/>	<input type="checkbox"/>	<input type="checkbox"/>	Ox00
1	<input type="checkbox"/>	<input type="checkbox"/>	<input type="checkbox"/>	<input type="checkbox"/>	<input type="checkbox"/>	<input type="checkbox"/>	<input type="checkbox"/>	<input type="checkbox"/>	Ox00
2	<input type="checkbox"/>	<input type="checkbox"/>	<input type="checkbox"/>	<input type="checkbox"/>	<input type="checkbox"/>	<input type="checkbox"/>	<input type="checkbox"/>	<input type="checkbox"/>	Ox00
3	<input type="checkbox"/>	<input type="checkbox"/>	<input type="checkbox"/>	<input type="checkbox"/>	<input type="checkbox"/>	<input type="checkbox"/>	<input type="checkbox"/>	<input type="checkbox"/>	Ox00

Inputs State								
0	<input type="checkbox"/>	<input type="checkbox"/>	<input type="checkbox"/>	<input type="checkbox"/>	<input type="checkbox"/>	<input type="checkbox"/>	<input type="checkbox"/>	Ox00
1	<input type="checkbox"/>	<input type="checkbox"/>	<input type="checkbox"/>	<input type="checkbox"/>	<input type="checkbox"/>	<input type="checkbox"/>	<input type="checkbox"/>	Ox00
2	<input type="checkbox"/>	<input type="checkbox"/>	<input type="checkbox"/>	<input type="checkbox"/>	<input type="checkbox"/>	<input type="checkbox"/>	<input type="checkbox"/>	Ox00
3	<input type="checkbox"/>	<input type="checkbox"/>	<input type="checkbox"/>	<input type="checkbox"/>	<input type="checkbox"/>	<input type="checkbox"/>	<input type="checkbox"/>	Ox00
4	<input type="checkbox"/>	<input type="checkbox"/>	<input type="checkbox"/>	<input type="checkbox"/>	<input type="checkbox"/>	<input type="checkbox"/>	<input type="checkbox"/>	Ox00
5	<input type="checkbox"/>	<input type="checkbox"/>	<input type="checkbox"/>	<input type="checkbox"/>	<input type="checkbox"/>	<input type="checkbox"/>	<input type="checkbox"/>	Ox00
6	<input type="checkbox"/>	<input type="checkbox"/>	<input type="checkbox"/>	<input type="checkbox"/>	<input type="checkbox"/>	<input type="checkbox"/>	<input type="checkbox"/>	Ox00
7	<input type="checkbox"/>	<input type="checkbox"/>	<input type="checkbox"/>	<input type="checkbox"/>	<input type="checkbox"/>	<input type="checkbox"/>	<input type="checkbox"/>	Ox00
8	<input type="checkbox"/>	<input type="checkbox"/>	<input type="checkbox"/>	<input type="checkbox"/>	<input type="checkbox"/>	<input type="checkbox"/>	<input type="checkbox"/>	Ox00
9	<input type="checkbox"/>	<input type="checkbox"/>	<input type="checkbox"/>	<input type="checkbox"/>	<input type="checkbox"/>	<input type="checkbox"/>	<input type="checkbox"/>	Ox00
10	<input type="checkbox"/>	<input type="checkbox"/>	<input type="checkbox"/>	<input type="checkbox"/>	<input type="checkbox"/>	<input type="checkbox"/>	<input type="checkbox"/>	Ox00
11	<input type="checkbox"/>	<input type="checkbox"/>	<input type="checkbox"/>	<input type="checkbox"/>	<input type="checkbox"/>	<input type="checkbox"/>	<input type="checkbox"/>	Ox00
12	<input type="checkbox"/>	<input type="checkbox"/>	<input type="checkbox"/>	<input type="checkbox"/>	<input type="checkbox"/>	<input type="checkbox"/>	<input type="checkbox"/>	Ox00
13	<input type="checkbox"/>	<input type="checkbox"/>	<input type="checkbox"/>	<input type="checkbox"/>	<input type="checkbox"/>	<input type="checkbox"/>	<input type="checkbox"/>	Ox00
14	<input type="checkbox"/>	<input type="checkbox"/>	<input type="checkbox"/>	<input type="checkbox"/>	<input type="checkbox"/>	<input type="checkbox"/>	<input type="checkbox"/>	Ox00
15	<input type="checkbox"/>	<input type="checkbox"/>	<input type="checkbox"/>	<input type="checkbox"/>	<input type="checkbox"/>	<input type="checkbox"/>	<input type="checkbox"/>	Ox00

Probe State								
0	<input type="checkbox"/>	<input type="checkbox"/>	<input type="checkbox"/>	<input type="checkbox"/>	<input type="checkbox"/>	<input type="checkbox"/>	<input type="checkbox"/>	Ox00
1	<input type="checkbox"/>	<input type="checkbox"/>	<input type="checkbox"/>	<input type="checkbox"/>	<input type="checkbox"/>	<input type="checkbox"/>	<input type="checkbox"/>	Ox00
2	<input type="checkbox"/>	<input type="checkbox"/>	<input type="checkbox"/>	<input type="checkbox"/>	<input type="checkbox"/>	<input type="checkbox"/>	<input type="checkbox"/>	Ox00
3	<input type="checkbox"/>	<input type="checkbox"/>	<input type="checkbox"/>	<input type="checkbox"/>	<input type="checkbox"/>	<input type="checkbox"/>	<input type="checkbox"/>	Ox00

Outputs State								
0	<input type="checkbox"/>	<input type="checkbox"/>	<input type="checkbox"/>	<input type="checkbox"/>	<input type="checkbox"/>	<input type="checkbox"/>	<input type="checkbox"/>	Ox00
1	<input type="checkbox"/>	<input type="checkbox"/>	<input type="checkbox"/>	<input type="checkbox"/>	<input type="checkbox"/>	<input type="checkbox"/>	<input type="checkbox"/>	Ox00
2	<input type="checkbox"/>	<input type="checkbox"/>	<input type="checkbox"/>	<input type="checkbox"/>	<input type="checkbox"/>	<input type="checkbox"/>	<input type="checkbox"/>	Ox00
3	<input type="checkbox"/>	<input type="checkbox"/>	<input type="checkbox"/>	<input type="checkbox"/>	<input type="checkbox"/>	<input type="checkbox"/>	<input type="checkbox"/>	Ox00

Fig. 14: Input/output status

Input Diagnostic	
0	<input type="checkbox"/>
1	<input type="checkbox"/>
2	<input type="checkbox"/>
3	<input type="checkbox"/>
4	<input type="checkbox"/>
5	<input type="checkbox"/>
6	<input type="checkbox"/>
7	<input type="checkbox"/>
8	<input type="checkbox"/>
9	<input type="checkbox"/>
10	<input type="checkbox"/>
11	<input type="checkbox"/>
12	<input type="checkbox"/>
13	<input type="checkbox"/>
14	<input type="checkbox"/>
15	<input type="checkbox"/>

Output Diagnostic	
0	<input type="checkbox"/>
1	<input type="checkbox"/>
2	<input type="checkbox"/>
3	<input type="checkbox"/>
4	<input type="checkbox"/>
5	<input type="checkbox"/>
6	<input type="checkbox"/>
7	<input type="checkbox"/>
8	<input type="checkbox"/>
9	<input type="checkbox"/>
10	<input type="checkbox"/>
11	<input type="checkbox"/>
12	<input type="checkbox"/>
13	<input type="checkbox"/>
14	<input type="checkbox"/>
15	<input type="checkbox"/>

Fig. 15: Input/output diagnostics

The fieldbus input, with a logical status that can be changed as required by the programmer (only for the module CE-US) or via the fieldbus, is indicated in the upper section of *Fig. 14*.

7.2. Example EUCHNER Safety Designer configuration

The examples in Fig. 16 and Fig. 17 show how the parameters are displayed. These figures show a project prepared using EUCHNER Safety Designer and how it is displayed in Bus Configurator.

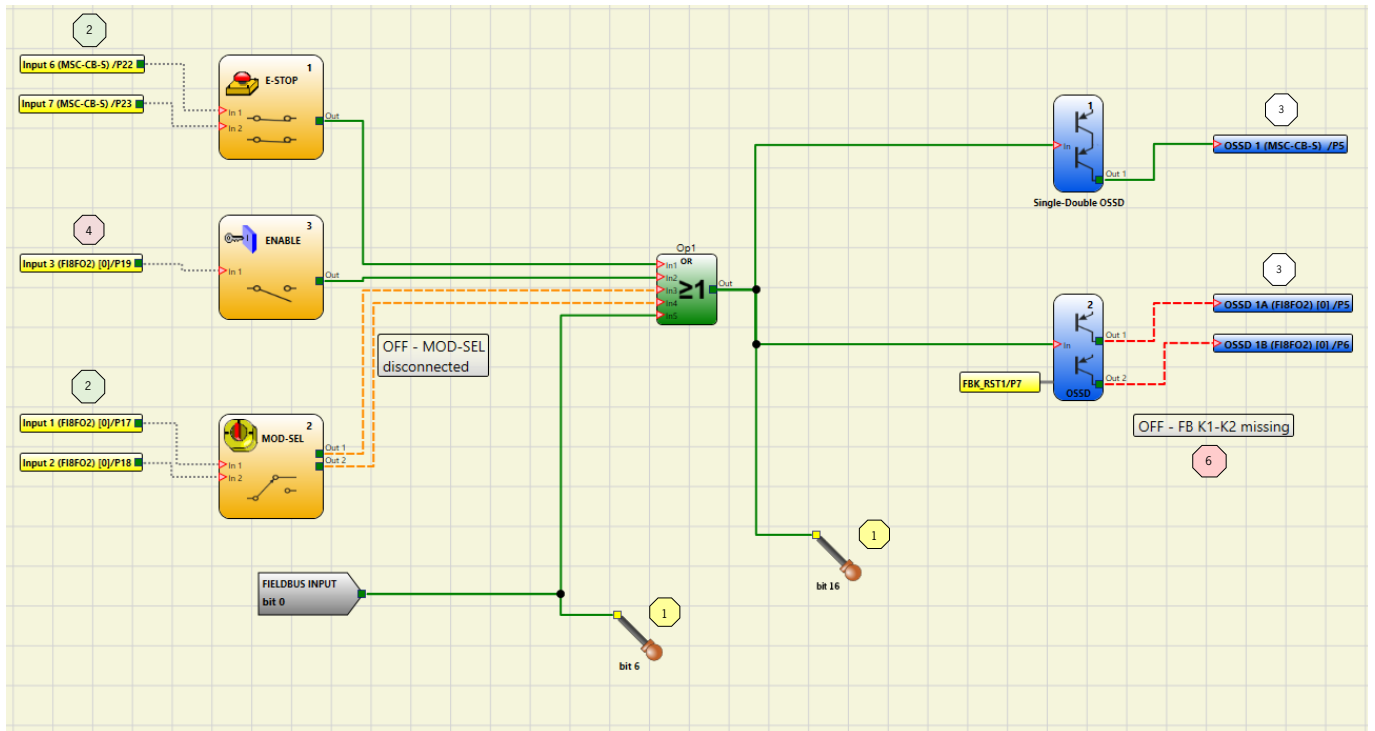

Fig. 16: Example of a project in EUCHNER Safety Designer

Fig. 17: Example of a project in the Bus Configurator

- The input block 1 “E-Stop” is connected to inputs 6/7, terminals K22/23, on the base unit. The corresponding status (0 or 1) is represented by bit 5 of byte 0 (“Input State” area). Bit 6 is set to 0; it is used to signal that the “E-Stop” occupies two terminals.
- The input block 2 “Enable” is connected to input 3, terminal K19 on the base unit. The corresponding status is represented by bit 7 of byte 0.
- The input block 3 “Mod-Sel” is connected to the inputs 1/2, terminals K17/18 on the FI8FO2 module. Here, the diagnostics indicates that MOD-SEL is not connected. The corresponding status is represented by the bit pair 0 and 1 of byte 1 (“Input State” area). The diagnostics information is displayed in the group box reserved for the input diagnostics, where 2 is displayed in the index field and the corresponding diagnostics information is displayed.
- The fieldbus outputs (FIELDBUS PROBE) on bits 6 and 16 are green, and the corresponding bits in the “Probe State” area are active. Bit 8 is displayed as bit 0 of the third byte.
- Output block 1 “OSSD” is ON and connected to the first output of the base unit. The corresponding status is represented by bit 0 of byte 0 (“Outputs State” area).
- The output block 2 “OSSD” is OFF; here, the diagnostics state that a restart is awaited. The OSSD is connected to the first output pair of FI8FO2. The corresponding status is represented by bit 2 of byte 0. The diagnostics are displayed in the group box reserved for diagnostics.
- Bit 0 is active in the “Fieldbus Input State” area.

8. Process data mapping

8.1. General Notes

1. The process data size is fixed, this means that the size and mapping of the process data image of the bus communication devices does not change depending on how many input or output modules are connected to the configurable safety controller.
2. "Reserved"-Bytes are allocated as variables where necessary (e.g., to maintain the inner sub-index structure of the CANopen user defined objects when an object is enlarged beyond 1 byte size)
3. Some data are available only if the communication module is used in a system where the MSC-CB/MS-CB-S firmware version is greater than a minimum value (i.e., Errors data are only available if MSC-CB/MS-CB-S firmware version is greater than 5.0, Project CRC data are available only with MSC-CB/MS-CB-S greater than 3.0).

8.2. EtherCAT (MSC CE-EC)

8.2.1. PDO predefined connection set

PDO Designation	Name	Length	Mapping Object
RxPDO 1	RxPDO 1	4 Byte	1600h
TxPDO 1	TxPDO 1	96 Byte	1A00h

8.2.2. Process data mapping (PDO)

RxPDO		Mapped object		Name
Index	Subindex	Index	Subindex	
1600 h	01h	2101h	01h	Fieldbus input byte 0
1600 h	02h	2101h	02h	Fieldbus input byte 1
1600 h	03h	2101h	03h	Fieldbus input byte 2
1600 h	04h	2101h	04h	Fieldbus input byte 3

TxPDO		Mapped object		Name
Index	Subindex	Index	Subindex	
1A00h	01h	2001h	01h	System status
1A00h	02h	2001h	02h	Reserved_2001_02
1A00h	03h	2001h	03h	Reserved_2001_03
1A00h	04h	2001h	04h	Reserved_2001_04
1A00h	05h	2001h	01h	Input status byte 0
1A00h	06h	2001h	02h	Input status byte 1
1A00h	07h	2001h	03h	Input status byte 2
1A00h	08h	2001h	04h	Input status byte 3
1A00h	09h	2001h	05h	Input status byte 4
1A00h	0Ah	2001h	06h	Input status byte 5
1A00h	0Bh	2001h	07h	Input status byte 6
1A00h	0Ch	2001h	08h	Input status byte 7
1A00h	0Dh	2001h	09h	Input status byte 8
1A00h	0Eh	2001h	0Ah	Input status byte 9
1A00h	0Fh	2001h	0Bh	Input status byte 10
1A00h	10h	2001h	0Ch	Input status byte 11
1A00h	11h	2001h	0Dh	Input status byte 12
1A00h	12h	2001h	0Eh	Input status byte 13
1A00h	13h	2001h	0Fh	Input status byte 14
1A00h	14h	2001h	10h	Input status byte 15

1A00h	15h	2181h	01h	Fieldbus input byte 0 feedback
1A00h	16h	2181h	02h	Fieldbus input byte 1 feedback
1A00h	17h	2181h	03h	Fieldbus input byte 2 feedback
1A00h	18h	2181h	04h	Fieldbus input byte 3 feedback
1A00h	19h	2203h	01h	Probe status byte 0
1A00h	1Ah	2203h	02h	Probe status byte 1
1A00h	1Bh	2203h	03h	Probe status byte 2
1A00h	1Ch	2203h	04h	Probe status byte 3
1A00h	1Dh	2202h	01h	OSSD status byte 0
1A00h	1Eh	2202h	02h	OSSD status byte 1
1A00h	1Fh	2202h	03h	OSSD status byte 2
1A00h	20h	2202h	04h	OSSD status byte 3
1A00h	21h	2204h	01h	Analog data float 0
1A00h	22h	2204h	02h	Analog data float 1
1A00h	23h	2204h	03h	Analog data float 2
1A00h	24h	2204h	04h	Analog data float 3
1A00h	25h	2204h	05h	Analog data float 4
1A00h	26h	2204h	06h	Analog data float 5
1A00h	27h	2204h	07h	Analog data float 6
1A00h	28h	2204h	08h	Analog data float 7
1A00h	29h	2204h	09h	Analog data float 8
1A00h	2Ah	2204h	0Ah	Analog data float 9
1A00h	2Bh	2204h	0Bh	Analog data float 10
1A00h	2Ch	2204h	0Ch	Analog data float 11
1A00h	2Dh	2204h	0Dh	Analog data float 12
1A00h	2Eh	2204h	0Eh	Analog data float 13
1A00h	2Fh	2204h	0Fh	Analog data float 14
1A00h	30h	2204h	10h	Analog data float 15

8.2.3. Vendor specific Objects

8.2.3.1. Object Index 2001h – System status

Object Type: Array

Subindex	Type	Name
00h	UNSIGNED8	Number Of Entries
01h	UNSIGNED8	System status
02h	UNSIGNED8	Reserved_2001_02
02h	UNSIGNED8	Reserved_2001_03
02h	UNSIGNED8	Reserved_2001_04

8.2.3.2. Object Index 2003h – Errors data CPU 0

Object Type: Array

Subindex	Type	Name
00h	UNSIGNED8	Number Of Entries
01h	UNSIGNED8	Module name
02h	UNSIGNED8	Error code
03h	UNSIGNED8	Error address byte 0
04h	UNSIGNED8	Error address byte 1
05h	UNSIGNED8	Error address byte 2
06h	UNSIGNED8	Error address byte 3
07h	UNSIGNED8	CPU firmware version
08h	UNSIGNED8	Extended code 0
09h	UNSIGNED8	Extended code 1

8.2.3.3. Object Index 2004h – Errors data CPU 1

Object Type: Array

Subindex	Type	Name
00h	UNSIGNED8	Number Of Entries
01h	UNSIGNED8	Module name
02h	UNSIGNED8	Error code
03h	UNSIGNED8	Error address byte 0
04h	UNSIGNED8	Error address byte 1
05h	UNSIGNED8	Error address byte 2
06h	UNSIGNED8	Error address byte 3
07h	UNSIGNED8	CPU firmware version
08h	UNSIGNED8	Extended code 0
09h	UNSIGNED8	Extended code 1

8.2.3.4. Object Index 2005h – Input diagnostics

Object Type: Array

Subindex	Type	Name
00h	UNSIGNED8	Number Of Entries
01h	UNSIGNED8	Diagnostic index 0
02h	UNSIGNED8	Diagnostic code 0
03h	UNSIGNED8	Diagnostic index 1
04h	UNSIGNED8	Diagnostic code 1
05h	UNSIGNED8	Diagnostic index 2
06h	UNSIGNED8	Diagnostic code 2
07h	UNSIGNED8	Diagnostic index 3
08h	UNSIGNED8	Diagnostic code 3
09h	UNSIGNED8	Diagnostic index 4
0Ah	UNSIGNED8	Diagnostic code 4
0Bh	UNSIGNED8	Diagnostic index 5
0Ch	UNSIGNED8	Diagnostic code 5
0Dh	UNSIGNED8	Diagnostic index 6
0Eh	UNSIGNED8	Diagnostic code 6
0Fh	UNSIGNED8	Diagnostic index 7
10h	UNSIGNED8	Diagnostic code 7
11h	UNSIGNED8	Diagnostic index 8
12h	UNSIGNED8	Diagnostic code 8
13h	UNSIGNED8	Diagnostic index 9
14h	UNSIGNED8	Diagnostic code 9
15h	UNSIGNED8	Diagnostic index 10
16h	UNSIGNED8	Diagnostic code 10
17h	UNSIGNED8	Diagnostic index 11
18h	UNSIGNED8	Diagnostic code 11
19h	UNSIGNED8	Diagnostic index 12
1Ah	UNSIGNED8	Diagnostic code 12
1Bh	UNSIGNED8	Diagnostic index 13
1Ch	UNSIGNED8	Diagnostic code 13
1Dh	UNSIGNED8	Diagnostic index 14
1Eh	UNSIGNED8	Diagnostic code 14
1Fh	UNSIGNED8	Diagnostic index 15
20h	UNSIGNED8	Diagnostic code 15

A maximum of 16 Input diagnostics are transferred, if more diagnostics are present on the system only the first 16 are available on the fieldbus.

8.2.3.5. Object Index 2006h – OSSD diagnostics

Object Type: Array

Subindex	Type	Name
00h	UNSIGNED8	Number Of Entries
01h	UNSIGNED8	Diagnostic index 0
02h	UNSIGNED8	Diagnostic code 0
03h	UNSIGNED8	Diagnostic index 1
04h	UNSIGNED8	Diagnostic code 1
05h	UNSIGNED8	Diagnostic index 2
06h	UNSIGNED8	Diagnostic code 2
07h	UNSIGNED8	Diagnostic index 3
08h	UNSIGNED8	Diagnostic code 3
09h	UNSIGNED8	Diagnostic index 4
0Ah	UNSIGNED8	Diagnostic code 4
0Bh	UNSIGNED8	Diagnostic index 5
0Ch	UNSIGNED8	Diagnostic code 5
0Dh	UNSIGNED8	Diagnostic index 6
0Eh	UNSIGNED8	Diagnostic code 6
0Fh	UNSIGNED8	Diagnostic index 7
10h	UNSIGNED8	Diagnostic code 7
11h	UNSIGNED8	Diagnostic index 8
12h	UNSIGNED8	Diagnostic code 8
13h	UNSIGNED8	Diagnostic index 9
14h	UNSIGNED8	Diagnostic code 9
15h	UNSIGNED8	Diagnostic index 10
16h	UNSIGNED8	Diagnostic code 10
17h	UNSIGNED8	Diagnostic index 11
18h	UNSIGNED8	Diagnostic code 11
19h	UNSIGNED8	Diagnostic index 12
1Ah	UNSIGNED8	Diagnostic code 12
1Bh	UNSIGNED8	Diagnostic index 13
1Ch	UNSIGNED8	Diagnostic code 13
1Dh	UNSIGNED8	Diagnostic index 14
1Eh	UNSIGNED8	Diagnostic code 14
1Fh	UNSIGNED8	Diagnostic index 15
20h	UNSIGNED8	Diagnostic code 15

A maximum of 16 OSSD diagnostics are transferred, if more diagnostics are present on the system only the first 16 are available on the fieldbus.

8.2.3.6. Object Index 2007h – Project CRC

Object Type: Array

Subindex	Type	Name
00h	UNSIGNED8	Number Of Entries
01h	UNSIGNED8	Project CRC High byte
02h	UNSIGNED8	Project CRC Low byte

8.2.3.7. Object Index 2101h – Fieldbus inputs

Object Type: Array

Subindex	Type	Name
00h	UNSIGNED8	Number Of Entries
01h	UNSIGNED8	Fieldbus input byte 0
02h	UNSIGNED8	Fieldbus input byte 1
03h	UNSIGNED8	Fieldbus input byte 2
04h	UNSIGNED8	Fieldbus input byte 3

8.2.3.8. Object Index 2181h – Fieldbus inputs feedback

Object Type: Array

Subindex	Type	Name
00h	UNSIGNED8	Number Of Entries
01h	UNSIGNED8	Fieldbus input byte 0 feedback
02h	UNSIGNED8	Fieldbus input byte 1 feedback
03h	UNSIGNED8	Fieldbus input byte 2 feedback
04h	UNSIGNED8	Fieldbus input byte 3 feedback

8.2.3.9. Object Index 2201h – Input status

Object Type: Array

Subindex	Type	Name
00h	UNSIGNED8	Number Of Entries
01h	UNSIGNED8	Input status byte 0
02h	UNSIGNED8	Input status byte 1
03h	UNSIGNED8	Input status byte 2
04h	UNSIGNED8	Input status byte 3
05h	UNSIGNED8	Input status byte 4
06h	UNSIGNED8	Input status byte 5
07h	UNSIGNED8	Input status byte 6
08h	UNSIGNED8	Input status byte 7
09h	UNSIGNED8	Input status byte 8
0Ah	UNSIGNED8	Input status byte 9
0Bh	UNSIGNED8	Input status byte 10
0Ch	UNSIGNED8	Input status byte 11
0Dh	UNSIGNED8	Input status byte 12
0Eh	UNSIGNED8	Input status byte 13
0Fh	UNSIGNED8	Input status byte 14
10h	UNSIGNED8	Input status byte 15

8.2.3.10. Object 2202h – OSSD status

Object Type: Array

Subindex	Type	Name
00h	UNSIGNED8	Number Of Entries
01h	UNSIGNED8	OSSD status byte 0
02h	UNSIGNED8	OSSD status byte 1
03h	UNSIGNED8	OSSD status byte 2
04h	UNSIGNED8	OSSD status byte 3

8.2.3.11. Object 2203h – Probe status

Object Type: Array

Subindex	Type	Name
00h	UNSIGNED8	Number Of Entries
01h	UNSIGNED8	Probe status byte 0
02h	UNSIGNED8	Probe status byte 1
03h	UNSIGNED8	Probe status byte 2
04h	UNSIGNED8	Probe status byte 3

8.2.3.12. Object Index 2204h – Analog data

Object Type: Array

Subindex	Type	Name
00h	UNSIGNED8	Number Of Entries
01h	REAL32	Analog data float 0
02h	REAL32	Analog data float 1
03h	REAL32	Analog data float 2
04h	REAL32	Analog data float 3
05h	REAL32	Analog data float 4
06h	REAL32	Analog data float 5
07h	REAL32	Analog data float 6
08h	REAL32	Analog data float 7
09h	REAL32	Analog data float 8
0Ah	REAL32	Analog data float 9
0Bh	REAL32	Analog data float 10
0Ch	REAL32	Analog data float 11
0Dh	REAL32	Analog data float 12
0Eh	REAL32	Analog data float 13
0Fh	REAL32	Analog data float 14
10h	REAL32	Analog data float 15

8.3. CANopen (MSC CE-CO)

8.3.1. PDO predefined connection set

PDO	Name	Length	Parameter	Mapping	Remarks
RxPDO 1	Fieldbus inputs	8 Byte	1400h	1600h	Part of the standard communication set
RxPDO 2	Dummy	8 Byte	1401h	1601h	Part of the standard communication set; not used; disabled by default
RxPDO 3	Dummy	8 Byte	1402h	1602h	
RxPDO 4	Dummy	8 Byte	1403h	1603h	
TxPDO 1	Status, Fieldbus inputs feedback	8 Byte	1800h	1A00h	
TxPDO 2	Inputs status 1	8 Byte	1801h	1A01h	Part of the standard communication set
TxPDO 3	Inputs status 2	8 Byte	1802h	1A02h	Part of the standard communication set
TxPDO 4	Outputs & Probes status	8 Byte	1803h	1A03h	Part of the standard communication set
TxPDO 5	Analog data 1	8 Byte	1804h	1A04h	
TxPDO 6	Analog data 2	8 Byte	1805h	1A05h	
TxPDO 7	Analog data 3	8 Byte	1806h	1A06h	
TxPDO 8	Analog data 4	8 Byte	1807h	1A07h	
TxPDO 9	Analog data 5	8 Byte	1808h	1A08h	
TxPDO 10	Analog data 6	8 Byte	1809h	1A09h	
TxPDO 11	Analog data 7	8 Byte	180Ah	1A0Ah	
TxPDO 12	Analog data 8	8 Byte	180Bh	1A0Bh	

8.3.2. Process data mapping (PDO)

RxPDO		Mapped object		Name
Index	Subindex	Index	Subindex	
1600h	01h	2101h	01h	Fieldbus input byte 0
1600h	02h	2001h	02h	Fieldbus input byte 1
1600h	03h	2001h	03h	Fieldbus input byte 2
1600h	04h	2001h	04h	Fieldbus input byte 3
1600h	05h	0005h	05h	Dummy entry
1600h	06h	0005h	06h	Dummy entry
1600h	07h	0005h	07h	Dummy entry
1600h	08h	0005h	08h	Dummy entry
1601h	01h	0005h	01h	Dummy entry
1601h	02h	0005h	02h	Dummy entry
1601h	03h	0005h	03h	Dummy entry
1601h	04h	0005h	04h	Dummy entry
1601h	05h	0005h	05h	Dummy entry
1601h	06h	0005h	06h	Dummy entry
1601h	07h	0005h	07h	Dummy entry
1601h	08h	0005h	08h	Dummy entry
1602h	01h	0005h	01h	Dummy entry
1602h	02h	0005h	02h	Dummy entry
1602h	03h	0005h	03h	Dummy entry
1602h	04h	0005h	04h	Dummy entry
1602h	05h	0005h	05h	Dummy entry
1602h	06h	0005h	06h	Dummy entry
1602h	07h	0005h	07h	Dummy entry
1602h	08h	0005h	08h	Dummy entry
1603h	01h	0005h	01h	Dummy entry
1603h	02h	0005h	02h	Dummy entry
1603h	03h	0005h	03h	Dummy entry
1603h	04h	0005h	04h	Dummy entry
1603h	05h	0005h	05h	Dummy entry
1603h	06h	0005h	06h	Dummy entry

1603h	07h	0005h	07h	Dummy entry
1603h	08h	0005h	08h	Dummy entry

TxPDO		Mapped object		Name
Index	Subindex	Index	Subindex	
1A00h	01h	2001h	01h	System status
1A00h	02h	0005h	00h	Dummy entry
1A00h	03h	0005h	00h	Dummy entry
1A00h	04h	0005h	00h	Dummy entry
1A00h	05h	2181h	01h	Fieldbus input byte 0 feedback
1A00h	06h	2181h	02h	Fieldbus input byte 1 feedback
1A00h	07h	2181h	03h	Fieldbus input byte 2 feedback
1A00h	08h	2181h	04h	Fieldbus input byte 3 feedback
1A01h	01h	2001h	01h	Input status byte 0
1A01h	02h	2001h	02h	Input status byte 1
1A01h	03h	2001h	03h	Input status byte 2
1A01h	04h	2001h	04h	Input status byte 3
1A01h	05h	2001h	05h	Input status byte 4
1A01h	06h	2001h	06h	Input status byte 5
1A01h	07h	2001h	07h	Input status byte 6
1A01h	08h	2001h	08h	Input status byte 7
1A02h	01h	2001h	09h	Input status byte 8
1A02h	02h	2001h	0Ah	Input status byte 9
1A02h	03h	2001h	0Bh	Input status byte 10
1A02h	04h	2001h	0Ch	Input status byte 11
1A02h	05h	2001h	0Dh	Input status byte 12
1A02h	06h	2001h	0Eh	Input status byte 13
1A02h	07h	2001h	0Fh	Input status byte 14
1A02h	08h	2001h	10h	Input status byte 15
1A03h	01h	2203h	01h	Probe status byte 0
1A03h	02h	2203h	02h	Probe status byte 1
1A03h	03h	2203h	03h	Probe status byte 2
1A03h	04h	2203h	04h	Probe status byte 3
1A03h	05h	2202h	01h	OSSD status byte 0
1A03h	06h	2202h	02h	OSSD status byte 1
1A03h	07h	2202h	03h	OSSD status byte 2
1A03h	08h	2202h	04h	OSSD status byte 3
1A04h	01h	2204h	01h	Analog data float 0
1A04h	02h	2204h	02h	Analog data float 1
1A05h	01h	2204h	03h	Analog data float 2
1A05h	02h	2204h	04h	Analog data float 3
1A06h	01h	2204h	05h	Analog data float 4
1A06h	02h	2204h	06h	Analog data float 5
1A07h	01h	2204h	07h	Analog data float 6
1A07h	02h	2204h	08h	Analog data float 7
1A08h	01h	2204h	09h	Analog data float 8
1A08h	02h	2204h	0Ah	Analog data float 9
1A09h	01h	2204h	0Bh	Analog data float 10
1A09h	02h	2204h	0Ch	Analog data float 11
1A0Ah	01h	2204h	0Dh	Analog data float 12
1A0Ah	02h	2204h	0Eh	Analog data float 13
1A0Bh	01h	2204h	0Fh	Analog data float 14
1A0Bh	02h	2204h	10h	Analog data float 15

8.3.3. Vendor specific Objects

8.3.3.1. Object Index 2001h – System status

Object Type: Array

Subindex	Type	Name
00h	UNSIGNED8	Number Of Entries
01h	UNSIGNED8	System status
02h	UNSIGNED8	Reserved
03h	UNSIGNED8	Reserved
04h	UNSIGNED8	Reserved

8.3.3.2. Object Index 2003h – Errors data CPU 0

Object Type: Array

Subindex	Type	Name
00h	UNSIGNED8	Number Of Entries
01h	UNSIGNED8	Module name
02h	UNSIGNED8	Error code
03h	UNSIGNED8	Error address byte 0
04h	UNSIGNED8	Error address byte 1
05h	UNSIGNED8	Error address byte 2
06h	UNSIGNED8	Error address byte 3
07h	UNSIGNED8	CPU firmware version
08h	UNSIGNED8	Extended code 0
09h	UNSIGNED8	Extended code 1

8.3.3.3. Object Index 2004h – Errors data CPU 1

Object Type: Array

Subindex	Type	Name
00h	UNSIGNED8	Number Of Entries
01h	UNSIGNED8	Module name
02h	UNSIGNED8	Error code
03h	UNSIGNED8	Error address byte 0
04h	UNSIGNED8	Error address byte 1
05h	UNSIGNED8	Error address byte 2
06h	UNSIGNED8	Error address byte 3
07h	UNSIGNED8	CPU firmware version
08h	UNSIGNED8	Extended code 0
09h	UNSIGNED8	Extended code 1

8.3.3.4. Object Index 2005h – Input diagnostics

Object Type: Array

Subindex	Type	Name
00h	UNSIGNED8	Number Of Entries
01h	UNSIGNED8	Diagnostic index 0
02h	UNSIGNED8	Diagnostic code 0
03h	UNSIGNED8	Diagnostic index 1
04h	UNSIGNED8	Diagnostic code 1
05h	UNSIGNED8	Diagnostic index 2
06h	UNSIGNED8	Diagnostic code 2
07h	UNSIGNED8	Diagnostic index 3
08h	UNSIGNED8	Diagnostic code 3
09h	UNSIGNED8	Diagnostic index 4
0Ah	UNSIGNED8	Diagnostic code 4
0Bh	UNSIGNED8	Diagnostic index 5

0Ch	UNSIGNED8	Diagnostic code 5
0Dh	UNSIGNED8	Diagnostic index 6
0Eh	UNSIGNED8	Diagnostic code 6
0Fh	UNSIGNED8	Diagnostic index 7
10h	UNSIGNED8	Diagnostic code 7
11h	UNSIGNED8	Diagnostic index 8
12h	UNSIGNED8	Diagnostic code 8
13h	UNSIGNED8	Diagnostic index 9
14h	UNSIGNED8	Diagnostic code 9
15h	UNSIGNED8	Diagnostic index 10
16h	UNSIGNED8	Diagnostic code 10
17h	UNSIGNED8	Diagnostic index 11
18h	UNSIGNED8	Diagnostic code 11
19h	UNSIGNED8	Diagnostic index 12
1Ah	UNSIGNED8	Diagnostic code 12
1Bh	UNSIGNED8	Diagnostic index 13
1Ch	UNSIGNED8	Diagnostic code 13
1Dh	UNSIGNED8	Diagnostic index 14
1Eh	UNSIGNED8	Diagnostic code 14
1Fh	UNSIGNED8	Diagnostic index 15
20h	UNSIGNED8	Diagnostic code 15

A maximum of 16 Input diagnostics are transferred, if more diagnostics are present on the system only the first 16 are available on the fieldbus.

8.3.3.5. Object Index 2006h – OSSD diagnostics

Object Type: Array

Subindex	Type	Name
00h	UNSIGNED8	Number Of Entries
01h	UNSIGNED8	Diagnostic index 0
02h	UNSIGNED8	Diagnostic code 0
03h	UNSIGNED8	Diagnostic index 1
04h	UNSIGNED8	Diagnostic code 1
05h	UNSIGNED8	Diagnostic index 2
06h	UNSIGNED8	Diagnostic code 2
07h	UNSIGNED8	Diagnostic index 3
08h	UNSIGNED8	Diagnostic code 3
09h	UNSIGNED8	Diagnostic index 4
0Ah	UNSIGNED8	Diagnostic code 4
0Bh	UNSIGNED8	Diagnostic index 5
0Ch	UNSIGNED8	Diagnostic code 5
0Dh	UNSIGNED8	Diagnostic index 6
0Eh	UNSIGNED8	Diagnostic code 6
0Fh	UNSIGNED8	Diagnostic index 7
10h	UNSIGNED8	Diagnostic code 7
11h	UNSIGNED8	Diagnostic index 8
12h	UNSIGNED8	Diagnostic code 8
13h	UNSIGNED8	Diagnostic index 9
14h	UNSIGNED8	Diagnostic code 9
15h	UNSIGNED8	Diagnostic index 10
16h	UNSIGNED8	Diagnostic code 10
17h	UNSIGNED8	Diagnostic index 11
18h	UNSIGNED8	Diagnostic code 11
19h	UNSIGNED8	Diagnostic index 12

1Ah	UNSIGNED8	Diagnostic code 12
1Bh	UNSIGNED8	Diagnostic index 13
1Ch	UNSIGNED8	Diagnostic code 13
1Dh	UNSIGNED8	Diagnostic index 14
1Eh	UNSIGNED8	Diagnostic code 14
1Fh	UNSIGNED8	Diagnostic index 15
20h	UNSIGNED8	Diagnostic code 15

A maximum of 16 OSSD diagnostics are transferred, if more diagnostics are present on the system only the first 16 are available on the fieldbus.

8.3.3.6. Object Index 2007h – Project CRC

Object Type: Array

Subindex	Type	Name
00h	UNSIGNED8	Number Of Entries
01h	UNSIGNED8	Project CRC Low byte
02h	UNSIGNED8	Project CRC High byte

8.3.3.7. Object Index 2101h – Fieldbus inputs

Object Type: Array

Subindex	Type	Name
00h	UNSIGNED8	Number Of Entries
01h	UNSIGNED8	Fieldbus input byte 0
02h	UNSIGNED8	Fieldbus input byte 1
03h	UNSIGNED8	Fieldbus input byte 2
04h	UNSIGNED8	Fieldbus input byte 3

8.3.3.8. Object Index 2181h – Fieldbus inputs feedback

Object Type: Array

Subindex	Type	Name
00h	UNSIGNED8	Number Of Entries
01h	UNSIGNED8	Fieldbus input byte 0 feedback
02h	UNSIGNED8	Fieldbus input byte 1 feedback
03h	UNSIGNED8	Fieldbus input byte 2 feedback
04h	UNSIGNED8	Fieldbus input byte 3 feedback

8.3.3.9. Object Index 2201h – Input status

Object Type: Array

Subindex	Type	Name
00h	UNSIGNED8	Number Of Entries
01h	UNSIGNED8	Input status byte 0
02h	UNSIGNED8	Input status byte 1
03h	UNSIGNED8	Input status byte 2
04h	UNSIGNED8	Input status byte 3
05h	UNSIGNED8	Input status byte 4
06h	UNSIGNED8	Input status byte 5
07h	UNSIGNED8	Input status byte 6
08h	UNSIGNED8	Input status byte 7
09h	UNSIGNED8	Input status byte 8
0Ah	UNSIGNED8	Input status byte 9
0Bh	UNSIGNED8	Input status byte 10
0Ch	UNSIGNED8	Input status byte 11
0Dh	UNSIGNED8	Input status byte 12
0Eh	UNSIGNED8	Input status byte 13

0Fh	UNSIGNED8	Input status byte 14
10h	UNSIGNED8	Input status byte 15

8.3.3.10. Object 2202h – OSSD status

Object Type: Array

Subindex	Type	Name
00h	UNSIGNED8	Number Of Entries
01h	UNSIGNED8	OSSD status byte 0
02h	UNSIGNED8	OSSD status byte 1
03h	UNSIGNED8	OSSD status byte 2
04h	UNSIGNED8	OSSD status byte 3

8.3.3.11. Object 2203h – Probe status

Object Type: Array

Subindex	Type	Name
00h	UNSIGNED8	Number Of Entries
01h	UNSIGNED8	Probe status byte 0
02h	UNSIGNED8	Probe status byte 1
03h	UNSIGNED8	Probe status byte 2
04h	UNSIGNED8	Probe status byte 3

8.3.3.12. Object Index 2204h – Analog data

Object Type: Array

Subindex	Type	Name
00h	UNSIGNED8	Number Of Entries
01h	REAL32	Analog data float 0
02h	REAL32	Analog data float 1
03h	REAL32	Analog data float 2
04h	REAL32	Analog data float 3
05h	REAL32	Analog data float 4
06h	REAL32	Analog data float 5
07h	REAL32	Analog data float 6
08h	REAL32	Analog data float 7
09h	REAL32	Analog data float 8
0Ah	REAL32	Analog data float 9
0Bh	REAL32	Analog data float 10
0Ch	REAL32	Analog data float 11
0Dh	REAL32	Analog data float 12
0Eh	REAL32	Analog data float 13
0Fh	REAL32	Analog data float 14
10h	REAL32	Analog data float 15

8.4. EtherNet/IP (MSC CE-EI)

8.4.1. Process data mapping (Class 1 Connection)

8.4.1.1. Assembly instance 96h (Connection point O->T Consuming Instance)

Byte offset	Size	Name
0	USINT	Fieldbus input byte 0
1	USINT	Fieldbus input byte 1
2	USINT	Fieldbus input byte 2
3	USINT	Fieldbus input byte 3

O->T connection type: Point-to-point

8.4.1.2. Assembly instance 64h (Connection point T->O Producing Instance)

Byte offset	Size	Name	Byte offset	Size	Name
0	USINT	System status	22	USINT	Probe status byte 0
1	USINT	Reserved	23	USINT	Probe status byte 1
2	USINT	Input status byte 0	24	USINT	Probe status byte 2
3	USINT	Input status byte 1	25	USINT	Probe status byte 3
4	USINT	Input status byte 2	26	USINT	OSSD status byte 0
5	USINT	Input status byte 3	27	USINT	OSSD status byte 1
6	USINT	Input status byte 4	28	USINT	OSSD status byte 2
7	USINT	Input status byte 5	29	USINT	OSSD status byte 3
8	USINT	Input status byte 6	30	REAL	Analog data float 0
9	USINT	Input status byte 7	34	REAL	Analog data float 1
10	USINT	Input status byte 8	38	REAL	Analog data float 2
11	USINT	Input status byte 9	42	REAL	Analog data float 3
12	USINT	Input status byte 10	46	REAL	Analog data float 4
13	USINT	Input status byte 11	50	REAL	Analog data float 5
14	USINT	Input status byte 12	54	REAL	Analog data float 6
15	USINT	Input status byte 13	58	REAL	Analog data float 7
16	USINT	Input status byte 14	62	REAL	Analog data float 8
17	USINT	Input status byte 15	66	REAL	Analog data float 9
18	USINT	Fieldbus input byte 0 feedback	70	REAL	Analog data float 10
19	USINT	Fieldbus input byte 1 feedback	74	REAL	Analog data float 11
20	USINT	Fieldbus input byte 2 feedback	78	REAL	Analog data float 12
21	USINT	Fieldbus input byte 3 feedback	82	REAL	Analog data float 13
			86	REAL	Analog data float 14
			90	REAL	Analog data float 15

T->O connection type: Point-to-point, Multicast.

8.4.1.3. Assembly instance 05h (Configuration Data)

Set this instance to size 0

Supported trigger types: Cyclic

8.4.2. Explicit messaging¹

To access Errors data, Input diagnostics, OSSD diagnostic and Project CRC the service 0x0E (Get attribute single) shall be used.

Name	Class	Instance	Attribute	Length (byte)	Access type
Fieldbus inputs	A2h	101h	05h	4	Set/Get
System I/O	A2h	01h	05h	30	Get
Analog data	A2h	204h	05h	64	Get
Errors data	A2h	03h	05h	9	Get
Errors data	A2h	04h	05h	9	Get
Input diagnostics	A2h	05h	05h	32	Get
OSSD diagnostics	A2h	06h	05h	32	Get
Project CRC	A2h	07h	05h	2	Get

¹ See 8.10. *Acyclic data format* for more information.

8.5. DeviceNet (MSC CE-DN)

8.5.1. Process data mapping

8.5.1.1. Assembly instance 96h (Consuming Instance)

Byte offset	Size	Name
0	USINT	Fieldbus input byte 0
1	USINT	Fieldbus input byte 1
2	USINT	Fieldbus input byte 2
3	USINT	Fieldbus input byte 3

8.5.1.2. Assembly instance 64h (Producing Instance)

Byte offset	Size	Name	Byte offset	Size	Name
0	USINT	System status	22	USINT	Probe status byte 0
1	USINT	Reserved	23	USINT	Probe status byte 1
2	USINT	Input status byte 0	24	USINT	Probe status byte 2
3	USINT	Input status byte 1	25	USINT	Probe status byte 3
4	USINT	Input status byte 2	26	USINT	OSSD status byte 0
5	USINT	Input status byte 3	27	USINT	OSSD status byte 1
6	USINT	Input status byte 4	28	USINT	OSSD status byte 2
7	USINT	Input status byte 5	29	USINT	OSSD status byte 3
8	USINT	Input status byte 6	30	REAL	Analog data float 0
9	USINT	Input status byte 7	34	REAL	Analog data float 1
10	USINT	Input status byte 8	38	REAL	Analog data float 2
11	USINT	Input status byte 9	42	REAL	Analog data float 3
12	USINT	Input status byte 10	46	REAL	Analog data float 4
13	USINT	Input status byte 11	50	REAL	Analog data float 5
14	USINT	Input status byte 12	54	REAL	Analog data float 6
15	USINT	Input status byte 13	58	REAL	Analog data float 7
16	USINT	Input status byte 14	62	REAL	Analog data float 8
17	USINT	Input status byte 15	66	REAL	Analog data float 9
18	USINT	Fieldbus input byte 0 feedback	70	REAL	Analog data float 10
19	USINT	Fieldbus input byte 1 feedback	74	REAL	Analog data float 11
20	USINT	Fieldbus input byte 2 feedback	78	REAL	Analog data float 12
21	USINT	Fieldbus input byte 3 feedback	82	REAL	Analog data float 13
			86	REAL	Analog data float 14
			90	REAL	Analog data float 15

8.5.2. Explicit messaging¹

To access Errors data, Input diagnostics, OSSD diagnostic and Project CRC the service 0x0E (Get attribute single) shall be used.

Name	Class	Instance	Attribute	Length (byte)	Access type
Fieldbus inputs	A2h	101h	05h	4	Set/Get
System I/O	A2h	01h	05h	30	Get
Analog data	A2h	204h	05h	64	Get
Errors data CPU 0	A2h	03h	05h	9	Get
Errors data CPU 1	A2h	04h	05h	9	Get
Input diagnostics	A2h	05h	05h	32	Get
OSSD diagnostics	A2h	06h	05h	32	Get
Project CRC	A2h	07h	05h	2	Get

¹ See 8.10. *Acyclic data format* for more information.

8.6. Modbus TCP/IP (MSC CE-MT) / Modbus Serial (MSC CE-MR)

8.6.1. Register mapping

8.6.1.1. Holding Registers (4x)

Register(s)	Size	Name	Register(s)	Size	Name
000h Low byte	UINT8	Fieldbus input byte 0	80Fh-810h	FLOAT	Analog data float 0
000h High byte	UINT8	Fieldbus input byte 1	811h-812h	FLOAT	Analog data float 1
001h Low byte	UINT8	Fieldbus input byte 2	813h-814h	FLOAT	Analog data float 2
001h High byte	UINT8	Fieldbus input byte 3	815h-816h	FLOAT	Analog data float 3
800h Low byte	UINT8	System status	817h-818h	FLOAT	Analog data float 4
800h High byte	UINT8	Reserved	819h-81Ah	FLOAT	Analog data float 5
801h Low byte	UINT8	Input status byte 0	81Bh-81Ch	FLOAT	Analog data float 6
801h High byte	UINT8	Input status byte 1	81Dh-81Eh	FLOAT	Analog data float 7
802h Low byte	UINT8	Input status byte 2	81Fh-820h	FLOAT	Analog data float 8
802h High byte	UINT8	Input status byte 3	821h-822h	FLOAT	Analog data float 9
803h Low byte	UINT8	Input status byte 4	823h-824h	FLOAT	Analog data float 10
803h High byte	UINT8	Input status byte 5	825h-826h	FLOAT	Analog data float 11
804h Low byte	UINT8	Input status byte 6	827h-828h	FLOAT	Analog data float 12
804h High byte	UINT8	Input status byte 7	829h-82Ah	FLOAT	Analog data float 13
805h Low byte	UINT8	Input status byte 8	82Bh-82Ch	FLOAT	Analog data float 14
805h High byte	UINT8	Input status byte 9	82Dh-82Eh	FLOAT	Analog data float 15
806h Low byte	UINT8	Input status byte 10	1030h Low byte	UINT8	Error CPU0 – Module
806h High byte	UINT8	Input status byte 11	1030h High byte	UINT8	Error CPU0 – Error code
807h Low byte	UINT8	Input status byte 12	1031h-1032h	UINT32	Error CPU0 – Error address
807h High byte	UINT8	Input status byte 13	1033h Low byte	UINT8	Error CPU0 – Firmware version
808h Low byte	UINT8	Input status byte 14	1033h High byte	UINT8	Error CPU0 – Extended code 0
808h High byte	UINT8	Input status byte 15	1034h Low byte	UINT8	Error CPU0 – Extended code 1
809h Low byte	UINT8	Fieldbus input feedback byte 0	1040h Low byte	UINT8	Error CPU1 – Module
809h High byte	UINT8	Fieldbus input feedback byte 1	1040h High byte	UINT8	Error CPU1 – Error code
80Ah Low byte	UINT8	Fieldbus input feedback byte 2	1041h-1042h	UINT32	Error CPU1 – Error address
80Ah High byte	UINT8	Fieldbus input feedback byte 3	1043h Low byte	UINT8	Error CPU1 – Firmware version
80Bh Low byte	UINT8	Probe status byte 0	1043h High byte	UINT8	Error CPU1 – Extended code 0
80Bh High byte	UINT8	Probe status byte 1	1044h Low byte	UINT8	Error CPU1 – Extended code 1
80Ch Low byte	UINT8	Probe status byte 2			
80Ch High byte	UINT8	Probe status byte 3			
80Dh Low byte	UINT8	OSSD status byte 0			
80Dh High byte	UINT8	OSSD status byte 1			
80Eh Low byte	UINT8	OSSD status byte 2			
80Eh High byte	UINT8	OSSD status byte 3			

Register(s)	Size	Name
1050h Low byte	UINT8	Input diagnostics index 1
1050h High byte	UINT8	Input diagnostics code 1
1051h Low byte	UINT8	Input diagnostics index 2
1051h High byte	UINT8	Input diagnostics code 2
1052h Low byte	UINT8	Input diagnostics index 3
1052h High byte	UINT8	Input diagnostics code 3
1053h Low byte	UINT8	Input diagnostics index 4
1053h High byte	UINT8	Input diagnostics code 4
1054h Low byte	UINT8	Input diagnostics index 5
1054h High byte	UINT8	Input diagnostics code 5
1055h Low byte	UINT8	Input diagnostics index 6
1055h High byte	UINT8	Input diagnostics code 6
1056h Low byte	UINT8	Input diagnostics index 7
1056h High byte	UINT8	Input diagnostics code 7
1057h Low byte	UINT8	Input diagnostics index 8
1057h High byte	UINT8	Input diagnostics code 8
1058h Low byte	UINT8	Input diagnostics index 9
1058h High byte	UINT8	Input diagnostics code 9
1059h Low byte	UINT8	Input diagnostics index 10
1059h High byte	UINT8	Input diagnostics code 10
105Ah Low byte	UINT8	Input diagnostics index 11
105Ah High byte	UINT8	Input diagnostics code 11
105Bh Low byte	UINT8	Input diagnostics index 12
105Bh High byte	UINT8	Input diagnostics code 12
105Ch Low byte	UINT8	Input diagnostics index 13
105Ch High byte	UINT8	Input diagnostics code 13
105Dh Low byte	UINT8	Input diagnostics index 14
105Dh High byte	UINT8	Input diagnostics code 14
105Eh Low byte	UINT8	Input diagnostics index 15
105Eh High byte	UINT8	Input diagnostics code 15
105Fh Low byte	UINT8	Input diagnostics index 16
105Fh High byte	UINT8	Input diagnostics code 16
1060h Low byte	UINT8	Output diagnostics index 1
1060h High byte	UINT8	Output diagnostics code 1
1061h Low byte	UINT8	Output diagnostics index 2
1061h High byte	UINT8	Output diagnostics code 2
1062h Low byte	UINT8	Output diagnostics index 3
1062h High byte	UINT8	Output diagnostics code 3
1063h Low byte	UINT8	Output diagnostics index 4
1063h High byte	UINT8	Output diagnostics code 4
1064h Low byte	UINT8	Output diagnostics index 5
1064h High byte	UINT8	Output diagnostics code 5
1065h Low byte	UINT8	Output diagnostics index 6
1065h High byte	UINT8	Output diagnostics code 6
1066h Low byte	UINT8	Output diagnostics index 7
1066h High byte	UINT8	Output diagnostics code 7
1067h Low byte	UINT8	Output diagnostics index 8
1067h High byte	UINT8	Output diagnostics code 8
1068h Low byte	UINT8	Output diagnostics index 9
1068h High byte	UINT8	Output diagnostics code 9
1069h Low byte	UINT8	Output diagnostics index 10
1069h High byte	UINT8	Output diagnostics code 10

Register(s)	Size	Name
106Ah Low byte	UINT8	Output diagnostics index 11
106Ah High byte	UINT8	Output diagnostics code 11
106Bh Low byte	UINT8	Output diagnostics index 12
106Bh High byte	UINT8	Output diagnostics code 12
106Ch Low byte	UINT8	Output diagnostics index 13
106Ch High byte	UINT8	Output diagnostics code 13
106Dh Low byte	UINT8	Output diagnostics index 14
106Dh High byte	UINT8	Output diagnostics code 14
106Eh Low byte	UINT8	Output diagnostics index 15
106Eh High byte	UINT8	Output diagnostics code 15
106Fh Low byte	UINT8	Output diagnostics index 16
106Fh High byte	UINT8	Output diagnostics code 16
1070h Low byte	UINT8	Project CRC High byte
1070h High byte	UINT8	Project CRC Low byte

8.7. CC-LINK (MBCCL)

8.7.1. Process data mapping

8.7.1.1. Master to slave

Bit area content

Register(s)	Content
RY #7... 0	System area
RY #15...8	

Word area content

Point(s)	Content (LSB)	Content (MSB)
RWw #0	Fieldbus input byte 1	Fieldbus input byte 0
RWw #1	Fieldbus input byte 3	Fieldbus input byte 2

8.7.1.2. Slave to master

Bit area content

Register(s)	Content
RY #7... 0	System area
RY #15...8	

Word area content

Point(s)	Content (LSB)	Content (MSB)
RWw #0	Reserved	System status
RWw #1	Input status byte 1	Input status byte 0
RWr #2	Input status byte 3	Input status byte 2
RWr #3	Input status byte 5	Input status byte 4
RWr #4	Input status byte 7	Input status byte 6
RWr #5	Input status byte 9	Input status byte 8
RWr #6	Input status byte 11	Input status byte 10
RWr #7	Input status byte 13	Input status byte 12
RWr #8	Input status byte 15	Input status byte 14
RWr #9	Fieldbus input feedback byte 1	Fieldbus input feedback byte 0
RWr #10	Fieldbus input feedback byte 3	Fieldbus input feedback byte 2
RWr #11	Probe status byte 1	Probe status byte 0
RWr #12	Probe status byte 3	Probe status byte 2
RWr #13	OSSD status byte 1	OSSD status byte 0
RWr #14	OSSD status byte 3	OSSD status byte 2
RWr #15	Analog data 0 byte 1	Analog data 0 byte 0
RWr #16	Analog data 0 byte 3	Analog data 0 byte 2
RWr #17	Analog data 1 byte 1	Analog data 1 byte 0
RWr #18	Analog data 1 byte 3	Analog data 1 byte 2
RWr #19	Analog data 2 byte 1	Analog data 2 byte 0
RWr #20	Analog data 2 byte 3	Analog data 2 byte 2
RWr #21	Analog data 3 byte 1	Analog data 3 byte 0
RWr #22	Analog data 3 byte 3	Analog data 3 byte 2
RWr #23	Analog data 4 byte 1	Analog data 4 byte 0
RWr #24	Analog data 4 byte 3	Analog data 4 byte 2
RWr #25	Analog data 5 byte 1	Analog data 5 byte 0
RWr #26	Analog data 5 byte 3	Analog data 5 byte 2
RWr #27	Analog data 6 byte 1	Analog data 6 byte 0
RWr #28	Analog data 6 byte 3	Analog data 6 byte 2
RWr #29	Analog data 7 byte 1	Analog data 7 byte 0
RWr #30	Analog data 7 byte 3	Analog data 7 byte 2
RWr #31	Analog data 8 byte 1	Analog data 8 byte 0

RWr #32	Analog data 8 byte 3	Analog data 8 byte 2
RWr #33	Analog data 9 byte 1	Analog data 9 byte 0
RWr #34	Analog data 9 byte 3	Analog data 9 byte 1
RWr #35	Analog data 10 byte 1	Analog data 10 byte 0
RWr #36	Analog data 10 byte 3	Analog data 10 byte 1
RWr #37	Analog data 11 byte 1	Analog data 11 byte 0
RWr #38	Analog data 11 byte 3	Analog data 11 byte 1
RWr #39	Analog data 12 byte 1	Analog data 12 byte 0
RWr #40	Analog data 12 byte 3	Analog data 12 byte 1
RWr #41	Analog data 13 byte 1	Analog data 13 byte 0
RWr #42	Analog data 13 byte 3	Analog data 13 byte 1
RWr #43	Analog data 14 byte 1	Analog data 14 byte 0
RWr #44	Analog data 14 byte 3	Analog data 14 byte 1
RWr #45	Analog data 15 byte 1	Analog data 15 byte 0
RWr #46	Analog data 15 byte 3	Analog data 15 byte 1
RWr #47	Error Code[LSB]	Error Code[MSB]

Please note that CC-Link does not allow acyclic exchange, so all the acyclic data like Errors, Diagnostics and Project CRC are not available.

8.8. PROFINET (MSC CE-PN)

8.8.1. Process data mapping

Module Fieldbus input

Byte offset	Data direction ²	Size	Name
0	In	UINT8	Fieldbus input byte 0
1	In	UINT8	Fieldbus input byte 1
2	In	UINT8	Fieldbus input byte 2
3	In	UINT8	Fieldbus input byte 3

² Direction from the MSC point of view

Module System I/O

Byte offset	Data direction ²	Size	Name
0	Out	UINT8	System status
1	Out	UINT8	Reserved
2	Out	UINT8	Input status byte 0
3	Out	UINT8	Input status byte 1
4	Out	UINT8	Input status byte 2
5	Out	UINT8	Input status byte 3
6	Out	UINT8	Input status byte 4
7	Out	UINT8	Input status byte 5
8	Out	UINT8	Input status byte 6
9	Out	UINT8	Input status byte 7
10	Out	UINT8	Input status byte 8
11	Out	UINT8	Input status byte 9
12	Out	UINT8	Input status byte 10
13	Out	UINT8	Input status byte 11
14	Out	UINT8	Input status byte 12
15	Out	UINT8	Input status byte 13
16	Out	UINT8	Input status byte 14
17	Out	UINT8	Input status byte 15
18	Out	UINT8	Fieldbus input byte 0 feedback
19	Out	UINT8	Fieldbus input byte 1 feedback
20	Out	UINT8	Fieldbus input byte 2 feedback
21	Out	UINT8	Fieldbus input byte 3 feedback
22	Out	UINT8	Probe status byte 0
23	Out	UINT8	Probe status byte 1
24	Out	UINT8	Probe status byte 2
25	Out	UINT8	Probe status byte 3
26	Out	UINT8	OSSD status byte 0
27	Out	UINT8	OSSD status byte 1
28	Out	UINT8	OSSD status byte 2
29	Out	UINT8	OSSD status byte 3

² Direction from the MSC point of view

Module Analog data

Byte offset	Data direction ²	Size	Name
0	Out	FLOAT	Analog data float 0
4	Out	FLOAT	Analog data float 1
8	Out	FLOAT	Analog data float 2
12	Out	FLOAT	Analog data float 3
16	Out	FLOAT	Analog data float 4
20	Out	FLOAT	Analog data float 5
24	Out	FLOAT	Analog data float 6
28	Out	FLOAT	Analog data float 7
32	Out	FLOAT	Analog data float 8
36	Out	FLOAT	Analog data float 9
40	Out	FLOAT	Analog data float 10
44	Out	FLOAT	Analog data float 11
48	Out	FLOAT	Analog data float 12
52	Out	FLOAT	Analog data float 13
56	Out	FLOAT	Analog data float 14
60	Out	FLOAT	Analog data float 15

² Direction from the MSC point of view

8.8.2. Record Data read/write services¹

Name	Slot	Index	Length (byte)	Access type
Fieldbus inputs	01h	01h	4	Set/Get
System I/O	00h	00h	30	Get
Analog data	02h	05h	64	Get
Errors data CPU 0	00h	03h	9	Get
Errors data CPU 1	00h	04h	9	Get
Input diagnostics	00h	05h	32	Get
OSSD diagnostics	00h	06h	32	Get
Project CRC	00h	07h	2	Get

¹ See 8.10. *Acyclic data format* for more information.

8.9. PROFIBUS DP (MSC CE-PR)

8.9.1. Process data mapping

Module 1 (with Analog data)

Byte offset	Data direction ²	Size	Name
0	Out	UINT8	System status
1	Out	UINT8	Reserved
2	Out	UINT8	Input status byte 0
3	Out	UINT8	Input status byte 1
4	Out	UINT8	Input status byte 2
5	Out	UINT8	Input status byte 3
6	Out	UINT8	Input status byte 4
7	Out	UINT8	Input status byte 5
8	Out	UINT8	Input status byte 6
9	Out	UINT8	Input status byte 7
10	Out	UINT8	Input status byte 8
11	Out	UINT8	Input status byte 9
12	Out	UINT8	Input status byte 10
13	Out	UINT8	Input status byte 11
14	Out	UINT8	Input status byte 12
15	Out	UINT8	Input status byte 13
16	Out	UINT8	Input status byte 14
17	Out	UINT8	Input status byte 15
18	Out	UINT8	Fieldbus input byte 0 feedback
19	Out	UINT8	Fieldbus input byte 1 feedback
20	Out	UINT8	Fieldbus input byte 2 feedback
21	Out	UINT8	Fieldbus input byte 3 feedback
22	Out	UINT8	Probe status byte 0
23	Out	UINT8	Probe status byte 1
24	Out	UINT8	Probe status byte 2
25	Out	UINT8	Probe status byte 3
26	Out	UINT8	OSSD status byte 0
27	Out	UINT8	OSSD status byte 1
28	Out	UINT8	OSSD status byte 2
29	Out	UINT8	OSSD status byte 3
30-33	Out	FLOAT	Analog data float 0
34-37	Out	FLOAT	Analog data float 1
38-41	Out	FLOAT	Analog data float 2
42-45	Out	FLOAT	Analog data float 3
46-49	Out	FLOAT	Analog data float 4
50-53	Out	FLOAT	Analog data float 5
54-57	Out	FLOAT	Analog data float 6
58-61	Out	FLOAT	Analog data float 7
62-65	Out	FLOAT	Analog data float 8
66-69	Out	FLOAT	Analog data float 9
70-73	Out	FLOAT	Analog data float 10
74-77	Out	FLOAT	Analog data float 11
78-81	Out	FLOAT	Analog data float 12
82-85	Out	FLOAT	Analog data float 13
86-89	Out	FLOAT	Analog data float 14
90-94	Out	FLOAT	Analog data float 15
0	In	UINT8	Fieldbus input byte 0
1	In	UINT8	Fieldbus input byte 1
2	In	UINT8	Fieldbus input byte 2

3	In	UINT8	Fieldbus input byte 3
---	----	-------	-----------------------

² Direction from the MSC point of view

Module 2 (without Analog data)

Byte offset	Data direction ²	Size	Name
0	Out	UINT8	System status
1	Out	UINT8	Reserved
2	Out	UINT8	Input status byte 0
3	Out	UINT8	Input status byte 1
4	Out	UINT8	Input status byte 2
5	Out	UINT8	Input status byte 3
6	Out	UINT8	Input status byte 4
7	Out	UINT8	Input status byte 5
8	Out	UINT8	Input status byte 6
9	Out	UINT8	Input status byte 7
10	Out	UINT8	Input status byte 8
11	Out	UINT8	Input status byte 9
12	Out	UINT8	Input status byte 10
13	Out	UINT8	Input status byte 11
14	Out	UINT8	Input status byte 12
15	Out	UINT8	Input status byte 13
16	Out	UINT8	Input status byte 14
17	Out	UINT8	Input status byte 15
18	Out	UINT8	Fieldbus input byte 0 feedback
19	Out	UINT8	Fieldbus input byte 1 feedback
20	Out	UINT8	Fieldbus input byte 2 feedback
21	Out	UINT8	Fieldbus input byte 3 feedback
22	Out	UINT8	Probe status byte 0
23	Out	UINT8	Probe status byte 1
24	Out	UINT8	Probe status byte 2
25	Out	UINT8	Probe status byte 3
26	Out	UINT8	OSSD status byte 0
27	Out	UINT8	OSSD status byte 1
28	Out	UINT8	OSSD status byte 2
29	Out	UINT8	OSSD status byte 3
0	In	UINT8	Fieldbus input byte 0
1	In	UINT8	Fieldbus input byte 1
2	In	UINT8	Fieldbus input byte 2
3	In	UINT8	Fieldbus input byte 3

² Direction from the MSC point of view

8.9.2. Record Data read/write services¹

Name	Slot	Index	Length (byte)	Access type
Fieldbus inputs	01h	01h	4	Set/Get
System I/O	00h	00h	30	Get
Analog data	02h	05h	64	Get
Errors data CPU 0	00h	02h	9	Get
Errors data CPU 1	00h	03h	9	Get
Input diagnostics	00h	04h	32	Get
OSSD diagnostics	00h	05h	32	Get
Project CRC	00h	06h	2	Get

¹ See 8.10. *Acyclic data format* for more information.

8.10. Acyclic data format

8.10.1. Errors data CPUx format

Name	Size
Module	UINT8
Error code	UINT8
Error address	UINT32
Firmware version (x.y in hexadecimal format)	UINT8
Extended code 0 (optional)	UINT8
Extended code 1 (optional)	UINT8

The Module field is defined as follow:

B7-B2	B1-B0
Module name	Node

The subfield Module name is defined as follow:

Name	Code	Name	Code
CE-AC-F18F02	2	CE-SPM0	10
CE-AC-F02	3	CE-AZ-F04	11
CE-F116	4	CE-AZ-F0408	12
CE-F18	5	CE-O8	13
CE-AC-F04	6	CE-O16	14
CE-FM4	7	CE-AH-F04S08	15
CE-SPM2	8	CE-AC-F18F04S	17
CE-SPM1	9		

For the Error code field please refer to the EUCHNER manual Dok.-Nr. 2121331 "Operating Instructions Installation and Use Modular Safety Control System MSC".

8.10.2. Input diagnostics format

Name	Size
Diagnostic index	UINT8
Diagnostic code	UINT8

A maximum of 16 Input diagnostics are transferred, if more diagnostics are present on the system only the first 16 are available on the fieldbus.

8.10.3. OSSD diagnostics format

Name	Size
Diagnostic index	UINT8
Diagnostic code	UINT8

A maximum of 16 OSSD diagnostics are transferred, if more diagnostics are present on the system only the first 16 are available on the fieldbus.

8.10.4. Project CRC format

Name	Size
CRC byte 0	UINT8
CRC byte 1	UINT8

Euchner GmbH + Co. KG
Kohlhammerstraße 16
70771 Leinfelden-Echterdingen
info@euchner.de
www.euchner.com

Edition:
2121341-09-12/23
Title:
Operating Instructions MODULAR SAFETY CONTROL SYSTEM
MSC
MSC FIELDBUS MODULES CE-...
(translation of the original operating instructions)
Copyright:
© EUCHNER GmbH + Co. KG, 12/2023

Subject to technical modifications; no responsibility is accepted for the accuracy of this information.