

# EUCHNER

## Operating Instructions

Non-Contact Safety Switch  
**CES-AP-C.2-... (Unicode/Multicode)**

EN

## Contents

<b>1.</b>	<b>About this document</b> .....	<b>4</b>
1.1.	Scope.....	4
1.2.	Target group .....	4
1.3.	Key to symbols.....	4
1.4.	Supplementary documents .....	4
<b>2.</b>	<b>Correct use</b> .....	<b>5</b>
<b>3.</b>	<b>Description of the safety function</b> .....	<b>6</b>
<b>4.</b>	<b>Exclusion of liability and warranty</b> .....	<b>6</b>
<b>5.</b>	<b>General safety precautions</b> .....	<b>6</b>
<b>6.</b>	<b>Function</b> .....	<b>7</b>
6.1.	Door monitoring output .....	7
6.2.	Diagnostic output .....	7
6.3.	Limit-range monitoring .....	7
6.4.	Switching states .....	7
<b>7.</b>	<b>Mounting</b> .....	<b>8</b>
<b>8.</b>	<b>Electrical connection</b> .....	<b>9</b>
8.1.	Notes about  .....	10
8.2.	Safety in case of faults.....	10
8.3.	Fuse protection for power supply .....	10
8.4.	Requirements for connecting cables.....	10
8.5.	Connector assignment of safety switch CES-AP-C.2.....	11
8.6.	Connection.....	12
8.7.	Notes on operation with safe control systems.....	13
8.8.	Devices for direct connection to IP65 field modules.....	13
<b>9.</b>	<b>Setup</b> .....	<b>14</b>
9.1.	LED displays .....	14
9.2.	Teach-in function for actuator (only for unicode evaluation) .....	14
9.2.1.	Preparing device for the teach-in operation and teaching-in actuator .....	14
9.3.	Functional check.....	15
9.3.1.	Electrical function test.....	15
<b>10.</b>	<b>System status table</b> .....	<b>16</b>

<b>11.</b>	<b>Technical data .....</b>	<b>17</b>
11.1.	Technical data of safety switch CES-AP-C.2-.....	17
11.1.1.	Typical system times.....	18
11.1.2.	Dimension drawing of safety switch CES-AP-C.2-.....	19
11.2.	Technical data of actuator CES-ABL-.....	20
11.2.1.	Dimension drawing.....	20
11.2.2.	Operating distances .....	21
11.2.3.	Typical actuating range.....	21
11.3.	Technical data of actuator CES-ABDN-06.....	22
11.3.1.	Dimension drawing.....	22
11.3.2.	Operating distances .....	22
<b>12.</b>	<b>Ordering information and accessories .....</b>	<b>23</b>
<b>13.</b>	<b>Inspection and service .....</b>	<b>23</b>
<b>14.</b>	<b>Service .....</b>	<b>23</b>
<b>15.</b>	<b>Declaration of conformity .....</b>	<b>24</b>

## 1. About this document





### 1.1. Scope

These operating instructions are valid for all CES-AP-C.2-... with version number V1.1.2 or higher. These operating instructions, the document *Safety information* and any enclosed data sheet form the complete user information for your device.

### 1.2. Target group



Design engineers and installation planners for safety devices on machines, as well as setup and servicing staff possessing special expertise in handling safety components.

### 1.3. Key to symbols

Symbol/depiction	Meaning
	Printed document
	Document is available for download at <a href="http://www.euchner.com">www.euchner.com</a>
 <b>DANGER</b> <b>WARNING</b> <b>CAUTION</b>	Safety precautions <b>Danger</b> of death or severe injuries <b>Warning</b> about possible injuries <b>Caution</b> slight injuries possible
 <b>NOTICE</b> <b>Important!</b>	<b>Notice</b> about possible device damage <b>Important</b> information
<b>Tip</b>	Useful information

### 1.4. Supplementary documents

The overall documentation for this device consists of the following documents:

Document title (document number)	Contents	
Safety information (2525460)	Basic safety information	
Operating instructions (2105360)	(this document)	
Possibly enclosed data sheet	Item-specific information about deviations or additions	

	<b>Important!</b> Always read all documents to gain a complete overview of safe installation, setup and use of the device. The documents can be downloaded from <a href="http://www.euchner.com">www.euchner.com</a> . For this purpose enter the doc. no. in the search box.
---	--

### 2. Correct use

Safety switches series CES-AP are interlocking devices without guard locking (type 4). The device meets the requirements according to EN IEC 60947-5-3. Devices with unicode evaluation possess a high coding level, devices with multicode evaluation possess a low coding level.

In combination with a movable guard and the machine control, this safety component prevents dangerous machine functions from occurring while the guard is open. A stop command is triggered if the guard is opened during the dangerous machine function.

This means:

- Starting commands that cause a dangerous machine function must become active only when the guard is closed.
- Opening the guard triggers a stop command.
- Closing a guard must not cause automatic starting of a dangerous machine function. A separate start command must be issued. For exceptions, refer to EN ISO 12100 or relevant C-standards.

Before the device is used, a risk assessment must be performed on the machine, e.g. in accordance with the following standards:

- EN ISO 13849-1
- EN ISO 12100
- IEC 62061

Correct use includes observing the relevant requirements for installation and operation, particularly based on the following standards:

- EN ISO 13849-1
- EN ISO 14119
- EN 60204-1

The safety switch is only allowed to be operated in conjunction with the intended EUCHNER CES actuators and the related connection components from EUCHNER. On the use of different actuators or other connection components, EUCHNER provides no warranty for safe function.



#### Important!

- The user is responsible for the proper integration of the device into a safe overall system. For this purpose, the overall system must be validated, e.g. in accordance with EN ISO 13849-2.
- It is only allowed to use components that are permissible in accordance with the table below.

Table 1: Possible combinations for CES components

Safety switch	Actuator				
	Door hinge right CES-A-BLN-R2-100776 100776	Door hinge left CES-A-BLN-L2-104510 104510	Usage independent of position of door hinge CES-A-BLN-U2-103450 103450		CES-A-BDN-06-104730 104730
Door hinge right CES-AP-CR2-...	●		●	●	
Door hinge left CES-AP-CL2-...		●	●		●
Key to symbols	●	Combination possible			

### 3. Description of the safety function

Devices from this series feature the following safety functions:

#### Monitoring of the guard position (interlocking device according to EN ISO 14119)

- Safety function:
  - The safety outputs are switched off when the guard is open (see chapter 6.4. *Switching states on page 7*).
- Safety characteristics: category, Performance Level, PFH<sub>D</sub> (see chapter 11. *Technical data on page 17*).

### 4. Exclusion of liability and warranty

In case of failure to comply with the conditions for correct use stated above, or if the safety regulations are not followed, or if any servicing is not performed as required, liability will be excluded and the warranty void.

### 5. General safety precautions

Safety switches fulfill personnel protection functions. Incorrect installation or tampering can lead to fatal injuries to personnel.

Check the safe function of the safeguard particularly

- after any setup work
- after the replacement of a system component
- after an extended period without use
- after every fault

Independent of these checks, the safe function of the guard should be checked at suitable intervals as part of the maintenance schedule.



#### **WARNING**

Danger to life due to improper installation or due to bypassing (tampering). Safety components fulfill a personnel protection function.

- Safety components must not be bypassed, turned away, removed or otherwise rendered ineffective. On this topic pay attention in particular to the measures for reducing the possibility of bypassing according to EN ISO 14119:2013, section 7.
- The switching operation must be triggered only by actuators designated for this purpose.
- Prevent bypassing by means of replacement actuators (only for multicode evaluation). For this purpose, restrict access to actuators and to keys for releases, for example.
- Mounting, electrical connection and setup only by authorized personnel possessing the following knowledge:
  - specialist knowledge in handling safety components
  - knowledge about the applicable EMC regulations
  - knowledge about the applicable regulations on operational safety and accident prevention.



#### **Important!**

Prior to use, read the operating instructions and keep these in a safe place. Ensure the operating instructions are always available during mounting, setup and servicing. For this reason you should archive a printed copy of the operating instructions. You can download the operating instructions from [www.euchner.com](http://www.euchner.com).

### 6. Function

The safety switch monitors the position of movable guards. The safety outputs are switched on/off when the actuator is moved to/removed from the actuating range.

The system consists of the following components: coded actuator (transponder) and switch.

Whether the device learns the complete actuator code (unicode) or not (multicode) depends on the respective version.

- ▶ **Devices with unicode evaluation:** The actuator must be assigned to the safety switch by a teach-in operation so that it is detected by the system. This unambiguous assignment ensures a particularly high level of protection against tampering. The system thus possesses a high coding level.
- ▶ **Devices with multicode evaluation:** Unlike systems with unique code detection, on multicode devices a specific code is not requested but instead it is only checked whether the actuator is of a type that can be detected by the system (multicode detection). There is no exact comparison of the actuator code with the taught-in code in the safety switch (unique code detection). The system possesses a low coding level.

When the guard is closed, the actuator is moved towards the safety switch. When the operating distance is reached, power is supplied to the actuator by the switch and data are transferred.

If a permissible code is detected, the safety outputs are switched on.

The safety outputs are turned off when the guard is opened.

In the event of a fault in the safety switch, the safety outputs are switched off and the DIA LED illuminates red. The occurrence of faults is detected at the latest on the next demand to close the safety outputs (e.g. on starting).

#### 6.1. Door monitoring output

The door monitoring output is switched on as soon as a valid actuator is detected in the actuating range.

#### 6.2. Diagnostic output

The diagnostic output is switched on in the event of a fault (switch-on condition as for DIA LED).

#### 6.3. Limit-range monitoring

If the safety door with the actuator should settle over time, the actuator can drift out of the read head actuating range. The device recognizes this situation and indicates that the actuator is in the limit range by flashing the STATE LED. This allows the safety door to be readjusted in time. Also see chapter 10. *System status table on page 16.*

#### 6.4. Switching states

The detailed switching states for your switch can be found in the system status table (see chapter 10. *System status table on page 16*). All safety outputs, monitoring outputs and display LEDs are described there.

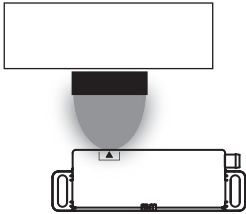
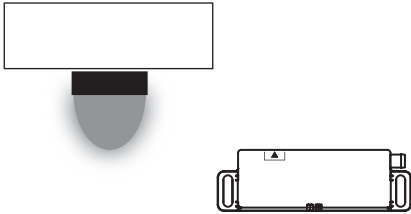
	Guard closed (actuator in the actuating range and permissible code detected)	Guard open (actuator not in the actuating range)
		
Safety outputs OA and OB	on	off
Monitoring output OUT	on	off

## 7. Mounting



### CAUTION

Safety switches must not be bypassed (bridging of contacts), turned away, removed or otherwise rendered ineffective.

- › Observe EN ISO 14119:2013, section 7, for information about reducing the possibilities for bypassing an interlocking device.



### NOTICE

Risk of damage to equipment and malfunctions as a result of incorrect installation.

- › Safety switches and actuators must not be used as an end stop.
- › Observe EN ISO 14119:2013, sections 5.2 and 5.3, for information about mounting the safety switch and the actuator.
- › From the assured release distance  $S_{ar}$ , the safety outputs are safely shut down.
- › When mounting several safety switches, observe the stipulated minimum distance to avoid mutual interference.

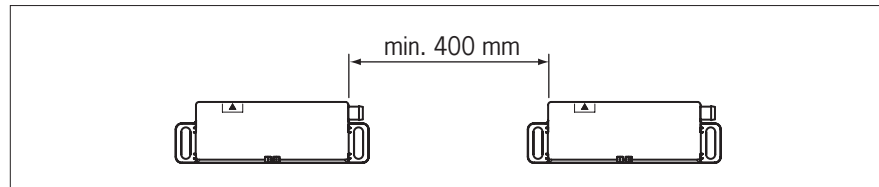

- › The operating distances change during the mounting of the actuator as a function of the material used for the guard.

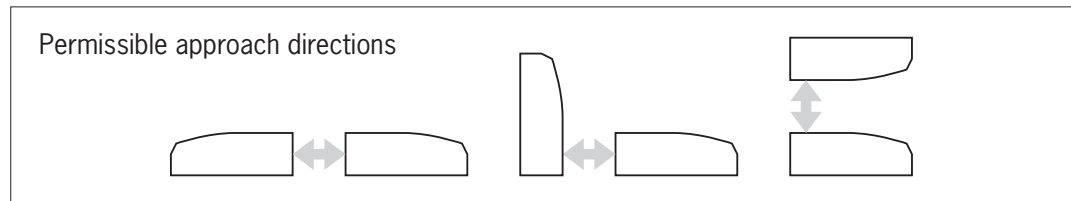

### Note the following points:

- › Actuator and safety switch must be easily accessible for inspection and replacement.
- › Actuator and safety switch must be fitted so that
  - the front faces are at the minimum operating distance  $0.8 \times S_{a0}$  or closer when the guard is closed. To avoid entering the area of possible side lobes, a minimum distance is to be maintained in case of a side approach direction. See chapter 11. *Technical data*, section *Typical actuating range* for the related actuator.
  - when the guard is open up to the distance  $S_{ar}$  (assured release distance), a hazard is excluded.
  - the actuator is positively mounted on the guard, e.g. by using the safety screws included.
  - The safety screws cannot be removed or tampered with using simple means.
- › Pay attention to the maximum tightening torque for the read head or safety switch and actuator fastenings of 1 Nm.



## 8. Electrical connection



### WARNING

- In the event of a fault, loss of the safety function due to incorrect connection.
- › To ensure safety, both safety outputs must always be evaluated.
  - › Monitoring outputs must not be used as safety outputs.
  - › Lay the connecting cables with protection to prevent the risk of short circuits.



### CAUTION

- Risk of damage to equipment or malfunctions as a result of incorrect connection.
- › The device generates its own clock signal on the output lines OA/OB. A downstream control system must tolerate these clock pulses, which may have a length of up to 0.3 ms. No clock pulses are output when the safety outputs are switched off.
  - › The inputs on a connected evaluation unit must be positive switching, as the two outputs on the safety switch deliver a level of +24 V in the switched-on state.
  - › All the electrical connections must either be isolated from the mains supply by a safety transformer according to IEC 61558-2-6 with limited output voltage in the event of a fault, or by other equivalent isolation measures (PELV).
  - › All electrical outputs must have an adequate protective circuit for inductive loads. The outputs must be protected with a free-wheeling diode for this purpose. RC interference suppression units must not be used.
  - › Power devices which are a powerful source of interference must be installed in a separate location away from the input and output circuits for signal processing. The cable routing for safety circuits should be as far away as possible from the cables of the power circuits.
  - › To avoid EMC interference, the physical environmental and operating conditions at the installation site of the device must comply with the requirements according to the standard EN 60204-1:2006, section 4.4.2 (EMC).
  - › Pay attention to any interference fields from devices such as frequency converters or induction heating systems. Observe the EMC instructions in the manuals from the respective manufacturer.





### Important!

If the device does not appear to function when operating voltage is applied (e.g. green STATE LED does not flash), the safety switch must be returned unopened to the manufacturer.

## 8.1. Notes about



### Important!

- ▶ This device is intended to be used with a *Class 2* power source in accordance with UL1310. As an alternative an LV/C (Limited Voltage/Current) power source with the following properties can be used:
  - This device shall be used with a suitable isolating source in conjunction with a fuse in accordance with UL248. The fuse shall be rated max. 3.3 A and be installed in the max. 30 V DC power supply to the device in order to limit the available current to comply with the  requirements. Please note possibly lower connection ratings for your device (refer to the technical data).
- ▶ For use and application as per the requirements of  1) a connecting cable listed under the UL category code CYJV2 or CYJV must be used.

1) Note on the scope of the UL approval: the devices have been tested as per the requirements of UL508 and CSA/ C22.2 no. 14 (protection against electric shock and fire). Only for applications as per NFPA 79 (Industrial Machinery).

## 8.2. Safety in case of faults

- ▶ The operating voltage  $U_B$  is reverse polarity protected.
- ▶ The safety outputs are short circuit-proof.
- ▶ A short circuit between the safety outputs is detected by the switch.
- ▶ A short circuit in the cable can be excluded by laying the cable with protection.

## 8.3. Fuse protection for power supply

The power supply must be provided with fuse protection depending on the number of switches and the current required for the outputs. The following rules apply:

### Max. current consumption of an individual switch $I_{max}$

$$I_{max} = I_{UB} + I_{OUT} + I_{OA+OB}$$

$$I_{UB} = \text{Switch operating current (30 mA)}$$

$$I_{OUT} = \text{Load current of monitoring outputs (max. 50 mA)}$$

$$I_{OA+OB} = \text{Load current of safety outputs OA + OB (2 x max. 150 mA)}$$

## 8.4. Requirements for connecting cables



### CAUTION

- Risk of damage to equipment or malfunctions as a result of incorrect connecting cables.
- ▶ Use connection components and connecting cables from EUCHNER.
  - ▶ On the use of other connection components, the requirements in the following table apply. EUCHNER provides no warranty for safe function in case of failure to comply with these requirements.
  - ▶ Observe the maximum cable length of 200 m.

Observe the following requirements with respect to the connecting cables:

Parameter	Value	Unit
Conductor cross-section, min.	0.14 ... 0.34	mm <sup>2</sup>
R max.	150	Ω/km
C max.	120	nF/km
L max.	0.65	mH/km
Recommended cable type	5x0.34 mm <sup>2</sup>	

### 8.5. Connector assignment of safety switch CES-AP-C.2

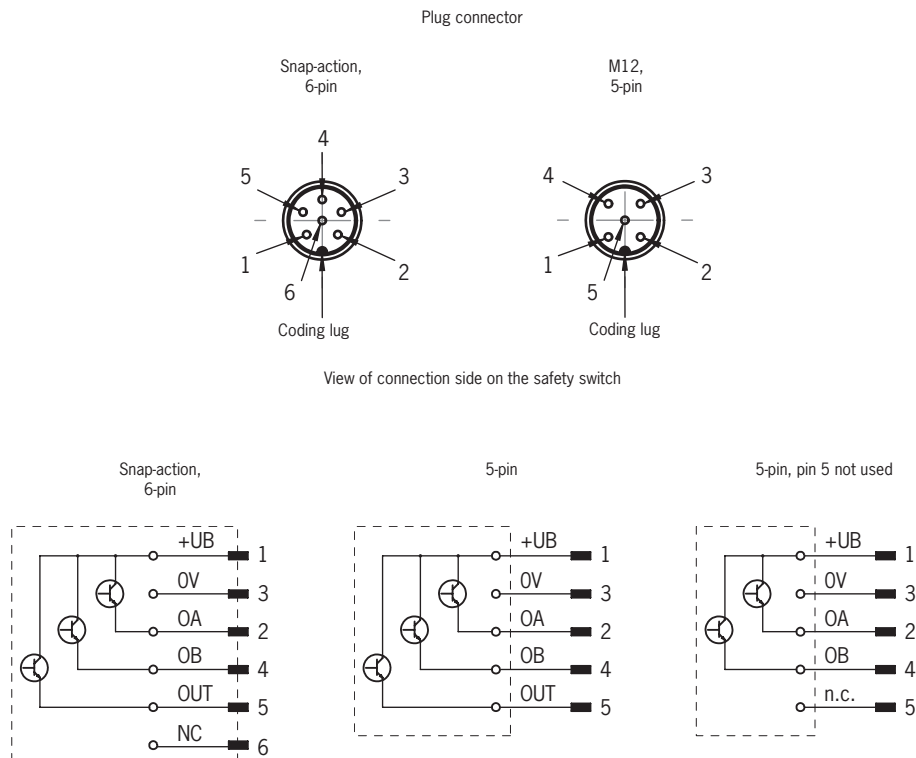

Figure 1: Connector assignment of safety switch CES-AP-C.2

Snap-action 6-pin		Pin Plug connector M12 5-pin, pin 5 not used		Designation	Description	Conductor coloring
1	1	1	1	UB	Power supply, DC 24 V	BN
2	2	2	2	OA	Safety output, channel 1	WH
3	3	3	3	OV	Ground, DC 0 V	BU
4	4	4	4	OB	Safety output, channel 2	BK
5	5	-	-	OUT	Monitoring output	GY
6	-	-	-	n.c.	Not used	PK

## 8.6. Connection



### WARNING

In the event of a fault, loss of the safety function due to incorrect connection.  
 ▶ To ensure safety, both safety outputs (OA and OB) must always be evaluated.



### Important!

The example shows only an excerpt that is relevant for connection of the CES system. The example illustrated here does not show complete system planning. The user is responsible for safe integration into the overall system. Detailed application examples can be found at [www.euchner.com](http://www.euchner.com). Simply enter the order number of your switch in the search box. You will find all available connection examples for the device in *Downloads*.

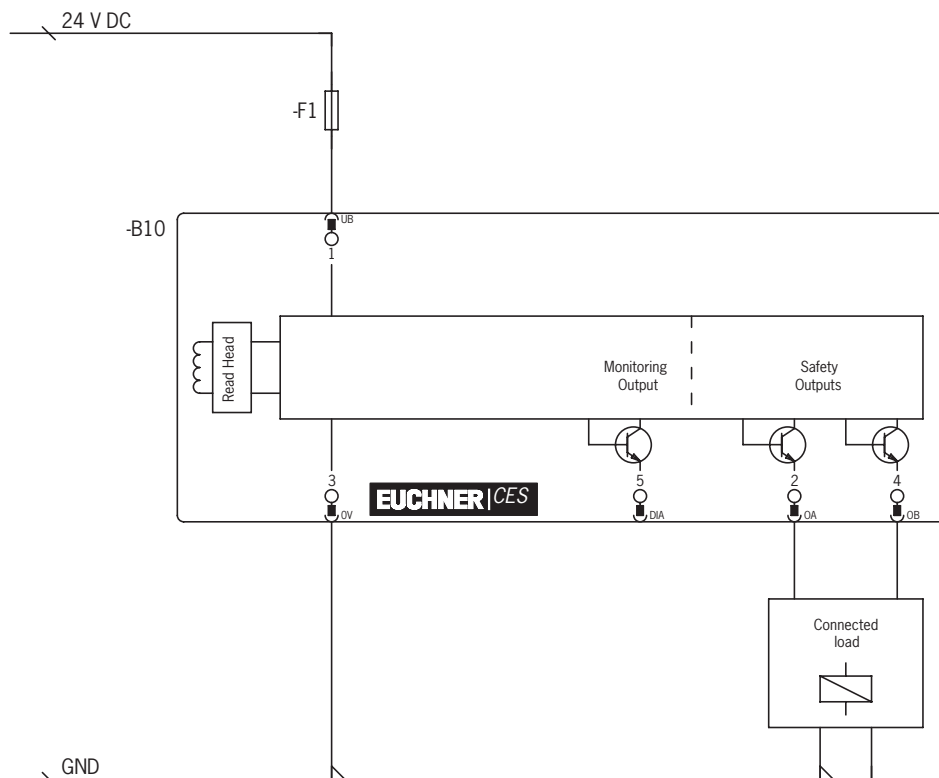

Figure 2: Connection example CES-AP-...

## 8.7. Notes on operation with safe control systems

Please observe the following requirements for connection to safe control systems:

- Use a common power supply for the control system and the connected safety switches.
- The device tolerates voltage interruptions at UB up to 5 ms in duration, provided that the time between two voltage interruptions is at least 110 ms. Tap the supply voltage directly from the power supply unit. If the power supply is connected to a terminal of a safe control system, this output must provide sufficient electrical current.
- The safety outputs (OA and OB) can be connected to the safe inputs of a control system. Prerequisite: The input must be suitable for pulsed safety signals (OSSD signals, e.g. from light grids). The control system must tolerate test pulses on the input signals. This normally can be set up by parameter assignment in the control system. Observe the notes of the control system manufacturer. For the test-pulse duration of your safety switch, please refer to chapter 11. *Technical data on page 17.*

A detailed example of connecting and setting the parameters of the control system is available for many devices at [www.euchner.com](http://www.euchner.com), in the area *Downloads/Applications/CES*. The features of the respective device are dealt with there in greater detail.

## 8.8. Devices for direct connection to IP65 field modules

The version CES-AP-...-SB-... (M12, 5-pin; pin 5 not assigned) is optimized for connection to decentralized peripheral systems with M12 plug connector, such as the ET200pro series from Siemens. The devices are parameterized and connected like an OSSD (e.g. like light curtains).

If flying leads are used, connection to IP20 input and output modules (e.g. ET200s) is naturally also possible.



### Important!

Observe the following notes prior to connection:

- Parameter assignment must be performed for the input/output modules (see application example at [www.euchner.com](http://www.euchner.com), in the area *Downloads/Applications/CES*).
- Additionally observe notes from the control system manufacturer where necessary.

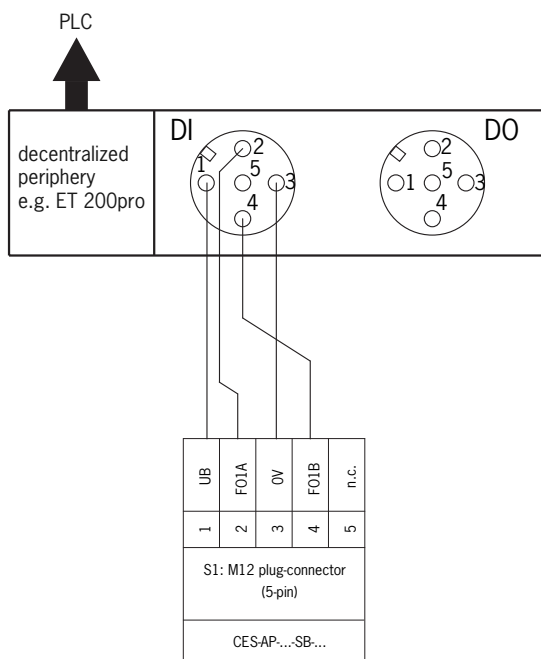

Figure 3: Connection example for connection to decentralized peripheral systems

## 9. Setup

### 9.1. LED displays

You will find a detailed description of the signal functions in chapter 10. *System status table on page 16.*

LED	Color
STATE	green
DIA	red

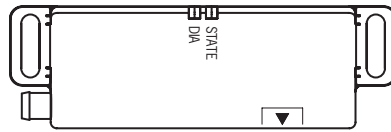

### 9.2. Teach-in function for actuator (only for unicode evaluation)

The actuator must be allocated to the safety switch using a teach-in function before the system forms a functional unit.

During a teach-in operation, the safety outputs and the monitoring output OUT are switched off, i.e. the system is in the safe state.



#### Important!

- › The teach-in operation may be performed only if the device functions flawlessly. The red DIA LED must not be illuminated.
- › The safety switch disables the code of the preceding device if teach-in is carried out for a new actuator. Teach-in is not possible again immediately for this device if a new teach-in operation is carried out. The disabled code is released again in the safety switch only after a third code has been taught-in.
- › The safety switch can be operated only with the last actuator taught-in.
- › The number of teach-in operations is unlimited.
- › After starting, the device remains in teach-in standby state for 3 min. If no new actuator is detected in this time, the device changes to normal operation. If the switch detects the actuator that was most recently taught-in when in the teach-in standby state, this state is ended immediately and the switch changes to normal operation.
- › If the actuator to be taught-in is within the actuating range for less than 60 s, it will not be activated and the most recently taught-in actuator will remain saved.
- › After an unsuccessful teach-in operation, the switch changes to normal operation.

#### 9.2.1. Preparing device for the teach-in operation and teaching-in actuator

1. Apply operating voltage to the safety switch.
  - ➔ A self-test is performed for approx. 0.5 s. After this, the LED flashes cyclically three times and signals that it is in standby state for teach-in.  
Standby state for teach-in remains active for approx. 3 minutes.
2. Move new actuator to the read head (observe distance  $< S_{a0}$ ).
  - ➔ Teach-in operation starts, green LED flashes (approx. 1 Hz). During the teach-in operation, the safety switch checks whether the actuator is a disabled actuator. Provided this is not the case, the teach-in operation is completed after approx. 60 seconds, and the green LED goes out. The new code has now been stored, and the old code is disabled.
3. To activate the new actuator code from the teach-in operation in the safety switch, the operating voltage to the safety switch must then be switched off for min. 3 seconds.

### 9.3. Functional check



#### WARNING

Danger of fatal injury as a result of faults in installation and functional check.

- › Before carrying out the functional check, make sure that there are no persons in the danger zone.
- › Observe the valid accident prevention regulations.















#### 9.3.1. Electrical function test

After installation and any fault, the safety function must be fully checked. Proceed as follows:

1. Switch on operating voltage.
  - ➔ The machine must not start automatically.
  - ➔ The safety switch carries out a self-test. The green STATE LED then flashes at regular intervals.
2. Close all guards.
  - ➔ The machine must not start automatically.
  - ➔ The green STATE LED illuminates continuously.
3. Enable operation in the control system.
4. Open the guard.
  - ➔ The machine must switch off and it must not be possible to start it as long as the guard is open.
  - ➔ The green STATE LED flashes at regular intervals.

Repeat steps 2 - 4 for each guard.

## 10. System status table

Operating mode	Actuator/door position	Safety outputs OA and OB	LED indicator Output		State
			STATE (green)	DIA (red)	
<b>Normal operation</b>	closed	on		○	Normal operation, door closed
	closed	on	 Inverted flash burst	○	Normal operation, door closed, actuator in the limit range → Re-adjust door
	open	off	 1 x	○	Normal operation, door open
	open	off	 2 x	○	Normal operation, door open; no actuator was taught in successfully during initial setup
<b>Teach-in operation</b> (only unicode)	open	off	 3 x	○	- Door open, device is ready for teach-in for a new actuator (only a short time after power-up). - Switches that have not been taught-in remain in teach-in standby until the teach-in operation starts.
	closed	off	 1 Hz	○	Teach-in operation
	X	off	○	○	Positive acknowledgment after completion of teach-in operation
<b>Fault display</b>	closed	off	 3 x		Defective actuator (e.g. fault in code or code not readable)
	X	off	 4 x		Output fault (e.g. short circuits, loss of switching ability)
	X	off	 5 x		Internal fault (e.g. component faulty, data error)
<b>Key to symbols</b>			○	LED not illuminated	
				LED illuminated	
			 10 Hz (8 s)	LED flashes for 8 seconds at 10 Hz	
			 3 x	LED flashes three times, cycle time 7 s	
			X	Any state	

After the cause has been remedied, faults can generally be reset by opening and closing the guard. If the fault is still displayed afterward, briefly interrupt the power supply. Please contact the manufacturer if the fault could not be reset after restarting.



### Important!

If you do not find the displayed device status in the system status table, this indicates an internal device fault. In this case, you should contact the manufacturer.



### 11. Technical data



#### NOTICE

If a data sheet is included with the product, the information on the data sheet applies.

#### 11.1. Technical data of safety switch CES-AP-C.2-...

Parameter	Value			Unit
	min.	typ.	max.	
Housing material	PBT plastic			
Dimensions	95 x 30 x 12			
Weight (device without connecting cable)	0.04			kg
Degree of protection	IP67/IP69K (IP67 for version with M12 plug connector)			
Safety class	III			
Degree of contamination	3			
Installation orientation	Any			
Connection	<ul style="list-style-type: none"> <li>- Plug connector with snap-action, 6-pin, or</li> <li>- Connecting cable PUR, 0.14 mm<sup>2</sup>, with plug connector M12, 5-pin, or</li> <li>- Connecting cable PVC with flying lead, 6 x 0.14 mm<sup>2</sup></li> </ul>			
Ambient temperature at U <sub>B</sub> = DC 24 V				°C
- Plug connector with snap-action	- 30	-	+ 65	
- Connecting cable laid rigidly	- 40	-	+ 65	
- Connecting cable movable	0	-	+ 65	
Storage temperature	- 40	-	+ 70	
Operating voltage U <sub>B</sub> (regulated, residual ripple < 5%)	24 ± 15% (PELV)			V DC
Current consumption	30			mA
External fuse (operating voltage)	0.25	-	8	A
Safety outputs OA/OB	Semiconductor outputs, p-switching, short circuit-proof			
- Output voltage U(OA)/U(OB) <sup>1)</sup>				
HIGH U(OA)	U <sub>B</sub> -1.5	-	U <sub>B</sub>	V DC
HIGH U(OB)				
LOW U(OA)/U(OB)	0		1	
Switching current per safety output	1	-	150	mA
Utilization category acc. to EN IEC 60947-5-2	DC-13 24 V 150 mA Caution: Outputs must be protected by a free-wheeling diode in the case of inductive loads.			
Off-state current I <sub>r</sub> <sup>2)</sup>	≤ 0.25			mA
Monitoring output DIA <sup>1)</sup>	p-switching, short circuit-proof			
- Output voltage	0.8 x U <sub>B</sub>	-	U <sub>B</sub>	V DC
- Max. load	-	-	50	mA
Rated insulation voltage U <sub>i</sub>	-	-	75	V
Rated impulse withstand voltage U <sub>imp</sub>	-	-	1.5	kV
Conditional short-circuit current	100			A
Resilience to vibration	Acc. to EN IEC 60947-5-2			
Switching frequency	-	-	1	Hz
Repeat accuracy R acc. to EN IEC 60947-5-2	≤ 10			%
EMC protection requirements	Acc. to EN IEC 60947-5-3			
Ready delay	-	0.5	-	s
Risk time	-	-	260	ms
Turn-on time	-	-	300	ms
Discrepancy time	-	-	10	ms
Test-pulse duration	300			µs
Test-pulse interval	100			ms
<b>Reliability values acc. to EN ISO 13849-1</b>				
Category	4			
Performance Level	PL e			
PFH <sub>D</sub>	1.8 x 10 <sup>-9</sup> / h			
Mission time	20			years

1) Values at a switching current of 50 mA without taking into account the cable length.

2) Maximum current at an output in switched-off state.

### 11.1.1. Typical system times

Please refer to the technical data for the exact values.

**Ready delay:** After switch-on, the device carries out a self-test. The system is ready for operation only after this time.

**Turn-on time of safety outputs:** The max. reaction time  $t_{on}$  is the time from the moment when the actuator is in the actuating range to the moment when the safety outputs switch on.

**Risk time according to EN 60947-5-3:** If an actuator moves outside the actuating range, the safety outputs (OA and OB) are deactivated at the latest after the risk time.

**Discrepancy time:** The safety outputs (OA and OB) switch with a slight time offset. They have the same signal state no later than after the discrepancy time.

**Test pulses at the safety outputs:** The device generates its own test pulses on the safety outputs (OA and OB). A downstream control system must tolerate these test pulses.

This can usually be set up in the control systems by parameter assignment. If parameter assignment is not possible for your control system or if shorter test pulses are required, please contact our support organization.

The test pulses are output only if the safety outputs are switched on.

### 11.1.2. Dimension drawing of safety switch CES-AP-C.2-...

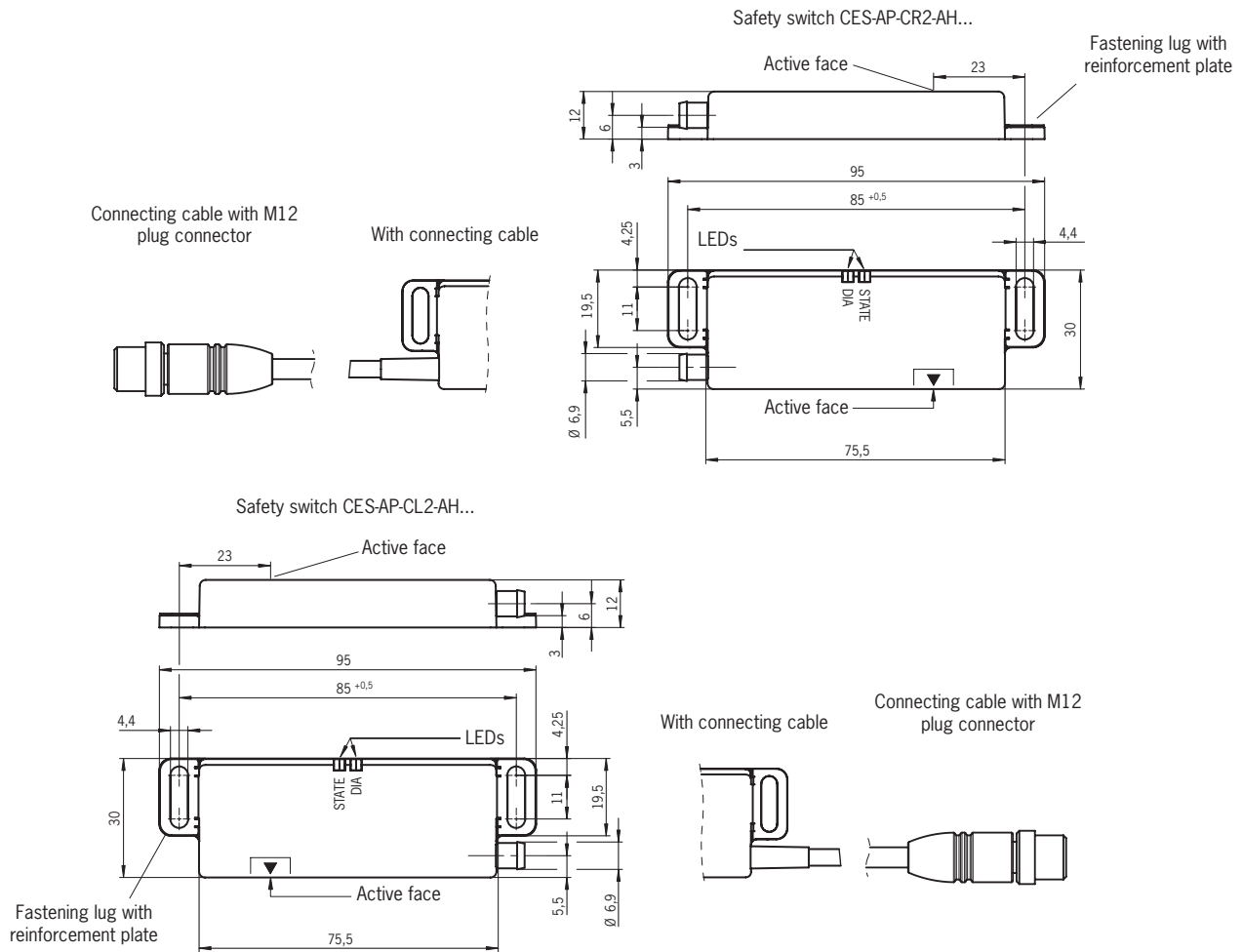

## 11.2. Technical data of actuator CES-A-BLN-...

Parameter	Value			Unit
	min.	typ.	max.	
Housing material	PBT plastic			
Dimensions - CES-A-BLN-R2/CES-A-BLN-L2 - CES-A-BLN-U2	95 x 30 x 12 55 x 30 x 12			mm
Weight - CES-A-BLN-R2/CES-A-BLN-L2 - CES-A-BLN-U2	0.04 0.02			kg
Ambient temperature	-40	-	+70	°C
Degree of protection	IP67/IP69K			
Installation orientation	Active face opposite read head			
Power supply	Inductive via read head			

### 11.2.1. Dimension drawing

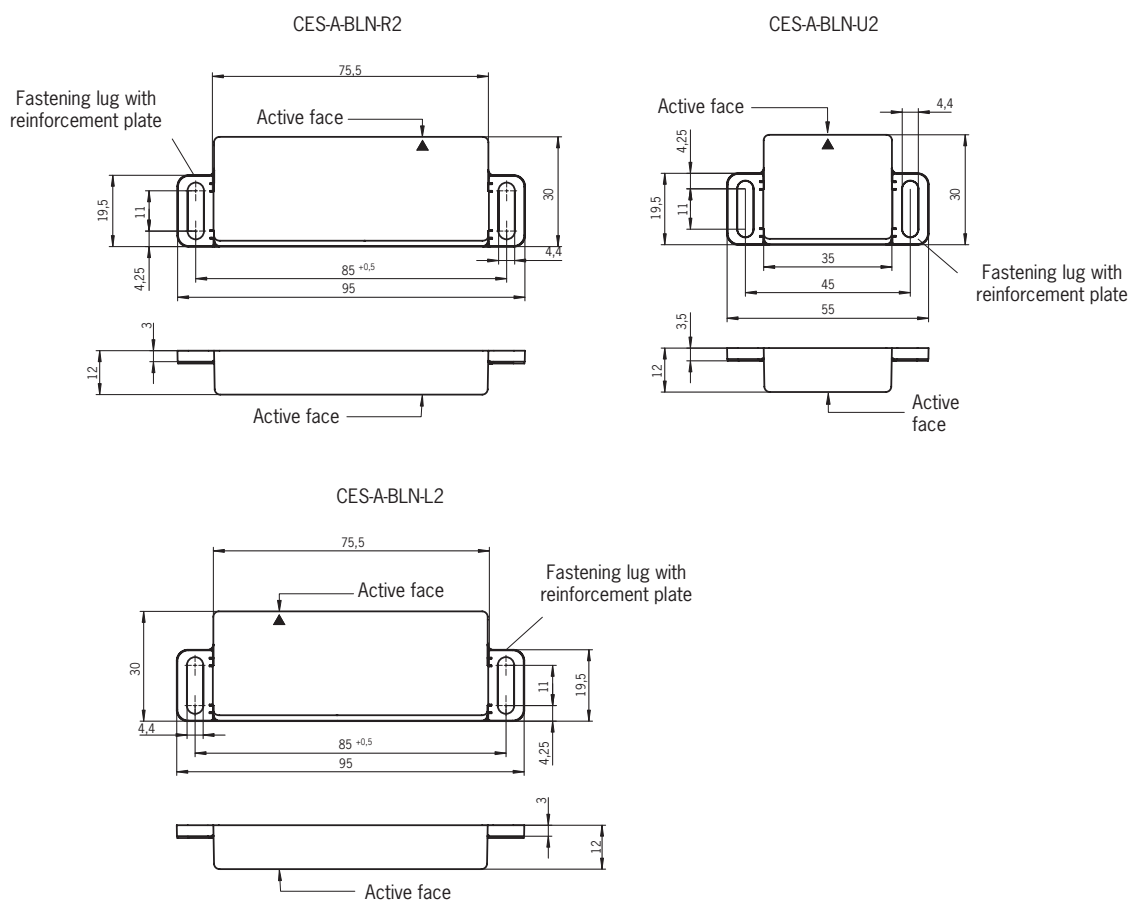

#### NOTICE

Two safety screws M4x14 included.

### 11.2.2. Operating distances

#### Actuating range for center offset $m = 0$ <sup>1)</sup>

Parameter	Value			Unit
	min.	typ.	max.	
Operating distance	-	15	-	mm
Assured operating distance $s_{ao}$	10	-	-	
Switching hysteresis	1	2	-	
Assured release distance $s_{ar}$	-	-	40	
- in x/z direction	-	-	60	
- in y direction	-	-	60	

1) The values apply to surface mounting of the actuator in metal.

### 11.2.3. Typical actuating range

(only in combination with actuator CES-ABL-...)

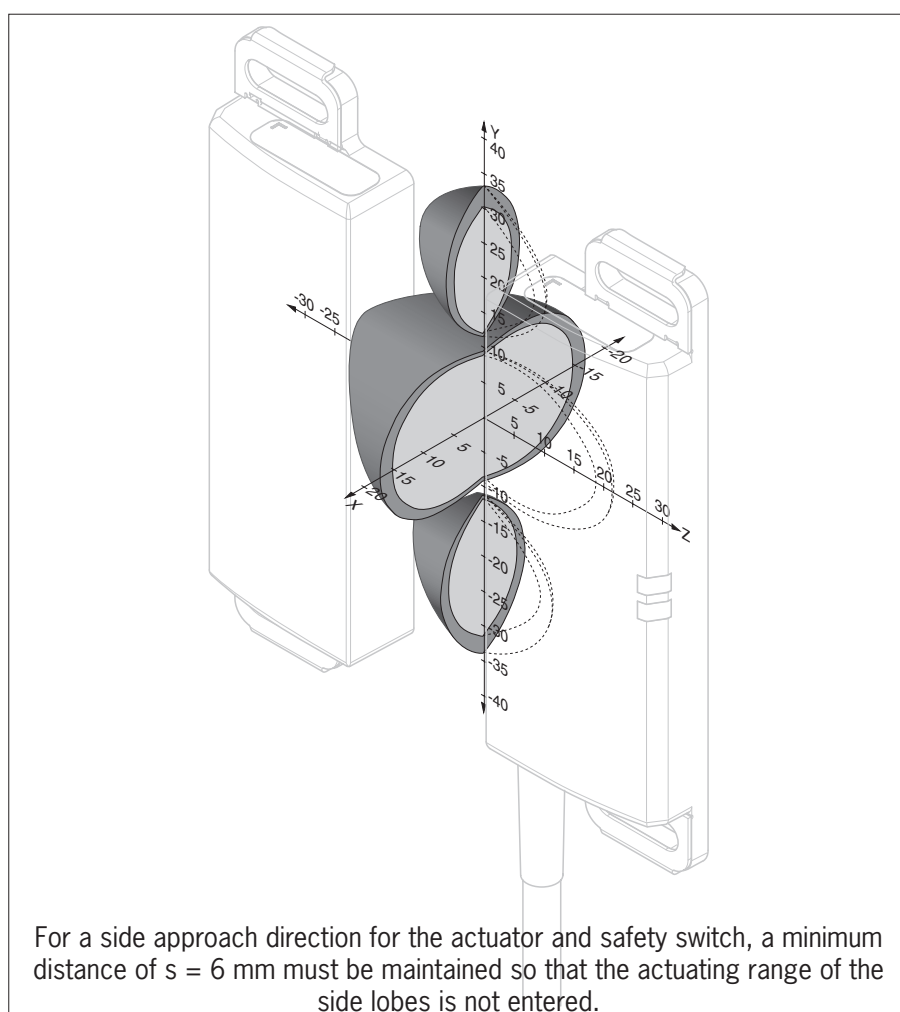
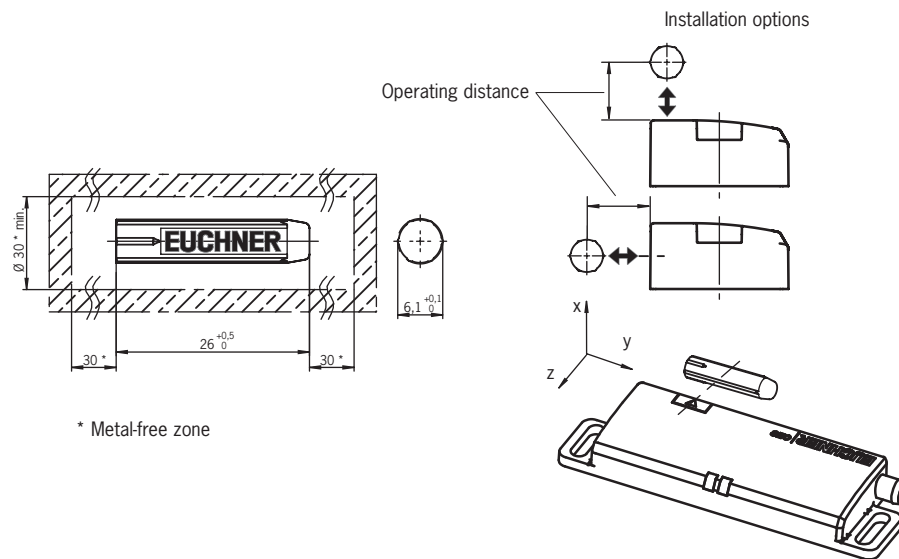

Figure 4: Typical actuating range

### 11.3. Technical data of actuator CES-A-BDN-06

According to drawing	Value			Unit
	min.	typ.	max.	
Housing material	Macromelt PA-based plastic			
Dimensions	26 x Ø 6			mm
Weight	0.005			kg
Ambient temperature	- 40	-	+ 70	°C
Degree of protection	IP65/IP67			
Installation orientation	Any			
Power supply	Inductive via read head			

#### 11.3.1. Dimension drawing



#### CAUTION

- Do not mount at temperatures below 0 °C.
- The actuator can be damaged during mounting.

#### 11.3.2. Operating distances

Actuating range for center offset  $m = 0$  <sup>1)</sup>

Parameter	Value			Unit
	min.	typ.	max.	
Operating distance	-	19	-	mm
Assured operating distance $s_{ao}$	14	-	-	
Switching hysteresis	-	2	-	
Assured release distance $s_{ar}$				
- in x/z direction	-	-	40	
- in y direction	-	-	60	

1) The values apply to surface mounting of the actuator in non-metallic material.

## 12. Ordering information and accessories



### Tip!

Suitable accessories, e.g. cables or assembly material, can be found at [www.euchner.com](http://www.euchner.com). To order, enter the order number of your item in the search box and open the item view. Accessories that can be combined with the item are listed in *Accessories*.

## 13. Inspection and service



### WARNING

Loss of the safety function because of damage to the device.

- › In case of damage, the entire device must be replaced.
- › Only accessories or spare parts that can be ordered from EUCHNER may be replaced.

Regular inspection of the following is necessary to ensure trouble-free long-term operation:

- › Check the switching function (see chapter 9.3. *Functional check on page 15*)
- › Check the secure mounting of the devices and the connections
- › Check for soiling

No servicing is required. Repairs to the device are only allowed to be made by the manufacturer.



### NOTICE

The year of manufacture can be seen in the lower right corner of the rating plate. The current version number in the format (VX.X.X) can also be found on the device.

## 14. Service

If servicing is required, please contact:

EUCHNER GmbH + Co. KG  
Kohlhammerstraße 16  
70771 Leinfelden-Echterdingen

### Service telephone:

+49 711 7597-500

### E-mail:

[support@euchner.de](mailto:support@euchner.de)

### Internet:

[www.euchner.com](http://www.euchner.com)

## 15. Declaration of conformity



**EUCHNER**

More than safety.

**EU-Konformitätserklärung**  
**EU declaration of conformity**  
**Déclaration UE de conformité**  
**Dichiarazione di conformità UE**  
**Declaración UE de conformidad**

Original DE  
Translation EN  
Traduction FR  
Traduzione IT  
Traducción ES

2109923-14-03/19

Die nachfolgend aufgeführten Produkte sind konform mit den Anforderungen der folgenden Richtlinien (falls zutreffend):  
The beneath listed products are in conformity with the requirements of the following directives (if applicable):  
Les produits mentionnés ci-dessous sont conformes aux exigences imposées par les directives suivantes (si valable)  
I prodotti sotto elencati sono conformi alle direttive sotto riportate (dove applicabili):  
Los productos listados a continuación son conforme a los requisitos de las siguientes directivas (si fueran aplicables):

I:	Maschinenrichtlinie Machinery directive Directive Machines Direttiva Macchine Directiva de máquinas	2006/42/EG 2006/42/EC 2006/42/CE 2006/42/CE 2006/42/CE
II:	Funkanlagen-Richtlinie (RED) Radio equipment directive Directive équipement radioélectrique Direttiva apparecchiatura radio Directiva equipo radioeléctrico	2014/53/EU 2014/53/EU 2014/53/UE 2014/53/UE 2014/53/UE
III:	RoHS Richtlinie RoHS directive Directive de RoHS Direttiva RoHS Directiva RoHS	2011/65/EU 2011/65/UE 2011/65/UE 2011/65/UE 2011/65/UE

Die Schutzziele der Niederspannungsrichtlinie 2014/35/EU und EMV Richtlinie 2014/30/EU werden gemäß Artikel 3.1 der Funkanlagen-Richtlinie eingehalten.  
The safety objectives of the Low-voltage directive 2014/35/EU and EMC Directive 2014/30/EU comply with article 3.1 of the Radio equipment directive.  
Les objectifs de sécurité de la Directive basse tension 2014/35/UE et Directive de CEM 2014/30/UE sont conformes à l'article 3.1 de la Directive équipement radioélectrique.  
Gli obiettivi di sicurezza della Direttiva bassa tensione 2014/35/UE e Direttiva CEM 2014/30/UE sono conformi a quanto riportato nell'articolo 3.1 della Direttiva apparecchiatura radio.  
Los objetivos de seguridad de la Directiva de bajo voltaje 2014/35/UE y Directiva CEM 2014/30/UE cumplen con el artículo 3.1 de la Directiva equipo radioeléctrico.

Folgende Normen sind angewandt: a: EN 60947-5-3:2013 e: EN 50364:2010  
Following standards are used: b: EN ISO 14119:2013 f: EN 300 330 V2.1.1  
Les normes suivantes sont appliquées: c: EN ISO 13849-1:2015  
Vengono applicate le seguenti norme: d: EN 50581:2012 (RoHS)  
Se utilizan los siguientes estándares:

Bezeichnung der Bauteile Description of components Description des composants Descrizione dei componenti Descripción de componentes	Type Type Type Tipo Tipo	Richtlinie Directives Directive Direttiva Directivas	Normen Standards Normes Norme Estándares	Zertifikats-Nr. No. of certificate Número du certificat Número del certificado Número del certificado
Sicherheitsschalter Safety Switches	CES-AP-CR2-... CES-AP-CL2-...	I, II, III	a, b, c, d, e, f	ET 19007
Interrupteurs de sécurité Fincorsa di sicurezza Interruptores de seguridad	CES-AP-C01-CH-SA CES-AR-C01-... CES-AR-CL2-... CES-AR-CR2-...			
Betätiger Actuator Actionneur Azionatore Actuador	CES-A-BLN... CES-A-BDN... CES-A-BBA... CES-A-BCA... CES-A-BPA... CES-A-BRN...	I, II, III	a, b, c, d, e, f	ET 19007 ET 19009 ET 18055

Benannte Stelle  
Notified Body  
Organisme notifié  
Sede indicata  
Entidad citada

NB 0340  
DGUV Test  
Prüf- und Zertifizierungsstelle Elektrotechnik  
Fachbereich ETEM  
Gustav-Heinemann-Ufer 130  
50968 Köln





# EUCHNER

More than safety.

Bezeichnung der Bauteile <i>Description of components</i> <i>Description des composants</i> <i>Descrizione dei componenti</i> <i>Descripción de componentes</i>	Type <i>Type</i> <i>Type</i> <i>Tipo</i> <i>Typo</i>	Richtlinie <i>Directives</i> <i>Directive</i> <i>Direttiva</i> <i>Directivas</i>	Normen <i>Standards</i> <i>Normes</i> <i>Norma</i> <i>Estándares</i>	Prüfbericht <i>Test report</i> <i>Rapport du test</i> <i>Rapporto di prova</i> <i>Informe de prueba</i>
Sicherheitsschalter <i>Safety Switches</i> <i>Interrupteurs de sécurité</i> <i>Finecorsa di sicurezza</i> <i>Interruptores de seguridad</i>	CES-AH-C03-AH-SM-106300	I, II, III	a, b, c, d, e, f	Euchner QS PB 21/2010
	CES-AP-C01...	I, II, III	a, b, c, d, e, f	Euchner QS PB 76/2010
Auswertegerät <i>Safety Unit</i> <i>Analyseur</i> <i>Centralina</i> <i>Unidad de evaluación</i>	CES-AR-AES-12	I, II, III	a, b, c, d, e, f	Euchner QS PB 53/2007
	CES-FD-AP...	I, II, III	a, b, c, d, e, f	UQS 116784
Betätiger <i>Actuator</i> <i>Actionneur</i> <i>Azionatore</i> <i>Actuador</i>	CES-A-BBN... CES-A-BMB...	I, II, III	a, b, c, d, e, f	UQS 116783 UQS 116784
Lesekopf <i>Read head</i> <i>Tête de lecture</i> <i>Testina di lettura</i> <i>Cabeza lectora</i>	CES-A-LMN-SC...	I, II, III	a, b, c, d, e, f	UQS 116784

Genehmigung der umfassenden Qualitätssicherung (UQS) durch die benannte Stelle  
*Approval of the full quality assurance system by the notified body*  
*Approbation du système d'assurance qualité complet par l'organisme notifié*  
*Approvazione del sistema di garanzia di qualità totale da parte dell'organismo notificato*  
*Aprobación del sistema de aseguramiento de calidad total por parte del organismo notificado*

0035  
TÜV Rheinland Industrie Service GmbH  
Alboinstr. 56, 12103 Berlin  
Germany

Die alleinige Verantwortung für die Ausstellung dieser Konformitätserklärung trägt der Hersteller:  
*This declaration of conformity is issued under the sole responsibility of the manufacturer:*  
*La présente déclaration de conformité est établie sous la seule responsabilité du fabricant:*  
*La presente dichiarazione di conformità è rilasciata sotto la responsabilità esclusiva del fabbricante:*  
*La presente declaración de conformidad se expide bajo la exclusiva responsabilidad del fabricante:*

EUCHNER GmbH + Co. KG  
Kohlhammerstraße 16  
70771 Leinfelden-Echterdingen  
Germany

Leinfelden, März 2019

EUCHNER GmbH + Co. KG  
Kohlhammerstraße 16  
70771 Leinfelden-Echterdingen  
Germany

i.A. Dipl.-Ing. Richard Holz  
Leiter Elektronik-Entwicklung  
*Manager Electronic Development*  
*Responsable Développement Électronique*  
*Direttore Sviluppo Elettronica*  
*Director de desarrollo electrónico*

i.A. Dipl.-Ing. (FH) Duc Binh Nguyen  
Dokumentationsbevollmächtigter  
*Documentation manager*  
*Responsable documentation*  
*Responsabilità della documentazione*  
*Agente documenta*





EUCHNER GmbH + Co. KG  
Kohlhammerstraße 16  
70771 Leinfelden-Echterdingen  
info@euchner.de  
www.euchner.com

Edition:  
2105360-12-05/20  
Title:  
Operating Instructions Non-Contact Safety Switch  
CES-AP-C.2-...  
(Translation of the original operating instructions)  
Copyright:  
© EUCHNER GmbH + Co. KG, 05/2020

Subject to technical modifications; no responsibility is accepted for the accuracy of this information.