

EUCHNER

Operating Instructions

Non-Contact Safety Switch
CES-I-AR-.-C04/C14-... (Unicode/Multicode)

EN

Contents

1.	About this document	4
1.1.	Scope.....	4
1.2.	Target group	4
1.3.	Key to symbols.....	4
1.4.	Supplementary documents	4
2.	Correct use	5
3.	Description of the safety function	6
4.	Exclusion of liability and warranty	6
5.	General safety precautions	7
6.	Function	8
6.1.	Door monitoring output	8
6.2.	Diagnostic output	8
6.3.	Limit-range monitoring	8
6.4.	Switching states	9
7.	Mounting	10
8.	Electrical connection	12
8.1.	Notes on 	13
8.2.	Safety in case of faults.....	13
8.3.	Fuse protection for power supply	13
8.4.	Requirements for connecting cables.....	14
8.5.	Maximum cable lengths.....	15
8.5.1.	Determining cable lengths using the example table.....	16
8.6.	Connector assignment of safety switch CES-I-AR--C04.....	17
8.7.	Terminal assignment of safety switch CES-I-AR--C14.....	17
8.8.	Connector assignment for Y-distributor	18
8.9.	Connection of a single AR device	19
8.10.	Connection of several devices in a switch chain	20
8.11.	Notes on operation on an AR evaluation unit	22
8.12.	Notes on operation with safe control systems.....	22
9.	Setup	24
9.1.	LED displays	24
9.2.	Teach-in function for actuator (only for unicode evaluation)	24
9.2.1.	Preparing device for the teach-in operation and teaching-in actuator	24
9.2.2.	Teach-in function with series connection, replacing and teaching-in device	25
9.3.	Functional check.....	25
9.3.1.	Electrical function test.....	25

10.	System status table CES-I-AR-.....	26
11.	Technical data	27
11.1.	Technical data for safety switch CES-I-AR-C04-.....	27
11.1.1.	Dimension drawing for safety switch CES-I-AR-C04-.....	28
11.2.	Technical data for safety switch CES-I-AR-.C14-.....	29
11.2.1.	Dimension drawing for safety switch CES-I-AR-C14-.....	30
11.3.	Typical system times.....	31
11.4.	Technical data for actuator CES-A-BBN-C04	32
11.4.1.	Dimension drawing.....	32
11.4.2.	Operating distances	32
11.4.3.	Typical operating distance in installation position A	33
11.5.	Technical data for actuator CES-A-BDN-06-161742.....	34
11.5.1.	Dimension drawing.....	34
11.5.2.	Operating distances	34
11.6.	Technical data for actuator CES-A-BDN-06-161742.....	35
11.6.1.	Dimension drawing.....	35
11.6.2.	Operating distances	35
11.7.	Technical data for actuator CES-A-BBN-161502.....	36
11.7.1.	Dimension drawing.....	36
11.7.2.	Operating distances	36
11.8.	Technical data for actuator CES-A-BBN-C14-160441.....	37
11.8.1.	Dimension drawing.....	37
11.8.2.	Operating distances	38
11.8.3.	Typical operating distance in installation position A	39
12.	Ordering information and accessories	40
13.	Inspection and service	40
14.	Service	40
15.	Declaration of conformity	40

1. About this document

1.1. Scope





These operating instructions apply to all CES-I-AR--C04/C14-... of version V1.0.X. These operating instructions, the document *Safety information* and any available data sheet form the complete user information for your device.

	<p>Important!</p> <p>Make sure to use the operating instructions valid for your product version. Please contact the EUCHNER service team if you have any questions.</p>
---	--

1.2. Target group





Design engineers and installation planners for safety systems on machines, as well as setup and servicing staff possessing special expertise in handling safety components.

1.3. Key to symbols

Symbol/depiction	Meaning
	Printed document
	Document is available for download at www.euchner.com
 DANGER WARNING CAUTION	<p>Safety precautions</p> <p>Danger of death or severe injuries</p> <p>Warning about possible injuries</p> <p>Caution slight injuries possible</p>
 NOTICE Important!	<p>Notice about possible device damage</p> <p>Important information</p>
Tip	Useful information

1.4. Supplementary documents

The overall documentation for this device consists of the following documents:

Document title (document number)	Contents	
Safety information (2525460)	Basic safety information	
Operating instructions (2119563)	(this document)	
Declaration of conformity	Declaration of conformity	
Possibly available data sheet	Item-specific information about deviations or additions	

	<p>Important!</p> <p>Always read all documents to gain a complete overview of safe installation, setup and use of the device. The documents can be downloaded from www.euchner.com. Simply enter the document number or the order number in the search box.</p>
---	---

2. Correct use

Safety switches series CES-I-AR are interlocking devices without guard locking (type 4). The device meets the requirements according to EN IEC 60947-5-3. Devices with unicode evaluation possess a high coding level, devices with multicode evaluation possess a low coding level.

In combination with a movable guard and the machine control, this safety component prevents dangerous machine functions from occurring while the guard is open. A stop command is triggered if the guard is opened during the dangerous machine function.

This means:

- › Starting commands that cause a dangerous machine function must become active only when the guard is closed.
- › Opening the guard triggers a stop command.
- › Closing a guard must not cause automatic starting of a dangerous machine function. A separate start command must be issued. For exceptions, refer to EN ISO 12100 or relevant C-standards.

Before the device is used, a risk assessment must be performed on the machine, e.g. in accordance with the following standards:

- › EN ISO 13849-1
- › EN ISO 12100
- › EN IEC 62061

Correct use includes observing the relevant requirements for installation and operation, particularly based on the following standards:

- › EN ISO 13849-1
- › EN ISO 14119
- › EN IEC 60204-1

The safety switch is only allowed to be operated in conjunction with the intended EUCHNER CES actuators and the related connection components from EUCHNER. If different actuators or other connection components are used, EUCHNER provides no warranty for safe function.

Connection of several devices in an AR switch chain is permitted only using devices intended for series connection in an AR switch chain. Check this in the instructions of the device in question.

A maximum of 20 safety switches are allowed to be operated in a switch chain.



Important!

- › The user is responsible for the proper integration of the device into a safe overall system. For this purpose, the overall system must be validated, e.g. in accordance with EN ISO 13849-1.
- › It is only allowed to use components that are permissible in accordance with the table below.

Table 1: Possible combinations for CES components

Safety switch	Actuator			
	CES-A-BBN-C04-115271	CES-A-BDN-06-104730 CES-A-BDN-06-161742	CES-A-BBN-161502	CES-A-BBN-C14-160441
CES-I-AR-.-C04-...	●	●	●	-
CES-I-AR-.-C14-...	●	-	-	●
Key to symbols	●	Combination possible		



NOTICE

The devices can be operated on an AR evaluation unit. Refer to the operating instructions for the relevant AR evaluation unit for more information.

3. Description of the safety function

Devices from this series feature the following safety functions:

Monitoring of the guard position (interlocking device according to EN ISO 14119)

- Safety function:
 - The safety outputs are switched off when the guard is open (see chapter 6.4. *Switching states on page 9*).
 - The following additionally applies in an AR series connection: The safety outputs are switched on only when the device receives a corresponding signal from its predecessor in the chain.
- Safety characteristics: category, Performance Level, PFH (see chapter 11. *Technical data on page 27*).



NOTICE

You can regard the complete AR device chain as one subsystem during calculation. The following calculation method applies to the PFH value:

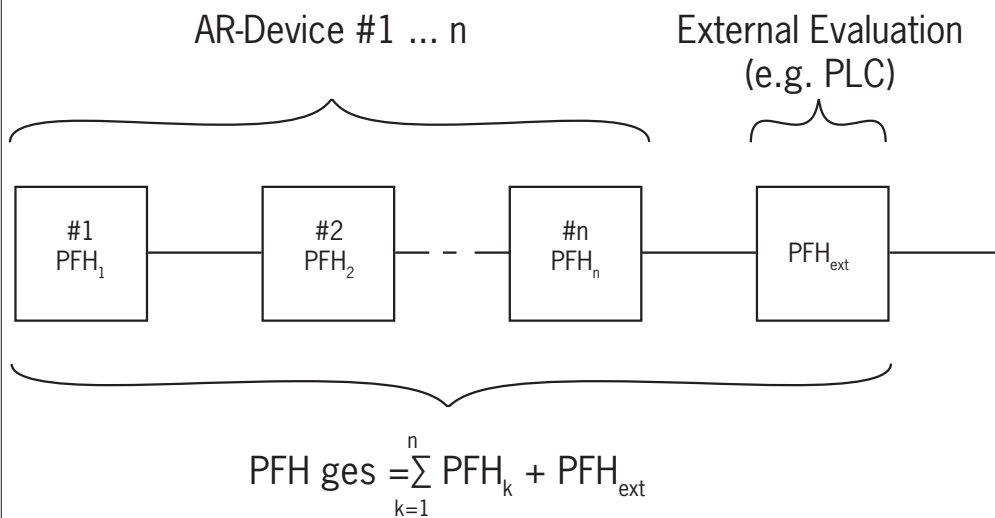

4. Exclusion of liability and warranty

In case of failure to comply with the conditions for correct use stated above, or if the safety regulations are not followed, or if any servicing is not performed as required, liability will be excluded and the warranty void.

5. General safety precautions

Safety switches fulfill personnel protection functions. Incorrect installation or tampering can lead to fatal injuries to personnel.

Check the safe function of the guard particularly

- › after any setup work
- › after the replacement of a system component
- › after an extended period without use
- › after every fault

Independent of these checks, the safe function of the guard should be checked at suitable intervals as part of the maintenance schedule.



WARNING

Danger to life due to improper installation or due to bypassing (tampering). Safety components fulfill a personnel protection function.

- › Safety components must not be bypassed, turned away, removed or otherwise rendered ineffective. On this topic pay attention in particular to the measures for reducing the possibility of bypassing according to EN ISO 14119:2025, section 8.
- › The switching operation must be triggered only by actuators designated for this purpose.
- › Prevent bypassing by means of replacement actuators (only for multicode evaluation). For this purpose, restrict access to actuators and to keys for releases, for example.
- › Mounting, electrical connection and setup only by authorized personnel possessing the following knowledge:
 - specialist knowledge in handling safety components
 - knowledge about the applicable EMC regulations
 - knowledge about the applicable regulations on operational safety and accident prevention.



Important!

Prior to use, read the operating instructions and keep these in a safe place. Ensure the operating instructions are always available during mounting, setup and servicing. For this reason you should archive a printed copy of the operating instructions. You can download the operating instructions from www.euchner.com.

6. Function

The safety switch monitors the position of movable guards. The safety outputs are switched on/off when the actuator is moved to/removed from the actuating range.

The system consists of the following components: coded actuator (transponder) and switch.

Whether the device learns the complete actuator code (unicode) or not (multicode) depends on the respective version.

- › **Devices with unicode evaluation:** The actuator must be assigned to the safety switch by a teach-in operation so that it is detected by the system. This unambiguous assignment ensures a particularly high level of protection against tampering. The system thus possesses a high coding level.
- › **Devices with multicode evaluation:** Unlike systems with unicode evaluation, on multicode devices a specific code is not requested but instead it is only checked whether the actuator is of a type that can be detected by the system (multicode evaluation). There is no exact comparison of the actuator code with the taught-in code in the safety switch (unicode evaluation). The system possesses a low coding level.
- › **Devices with fixcode evaluation:** For devices of the fixcode version, a permanently assigned actuator of series CES-A-BBN is supplied with the device. The device can be operated only with this one actuator. No additional actuators can be taught in. This unambiguous assignment ensures a particularly high level of protection against tampering.

When the guard is closed, the actuator is moved toward the safety switch. When the operating distance is reached, power is supplied to the actuator by the switch and data are transferred.

If a permissible code is detected, the safety outputs are switched on.

The safety outputs are switched off when the guard is opened.

In the event of a fault in the safety switch, the safety outputs are switched off and the DIA LED illuminates red. The occurrence of faults is detected at the latest on the next demand to close the safety outputs (e.g. on starting).

6.1. Door monitoring output

The door monitoring output is switched on as soon as a valid actuator is detected in the actuating range.

6.2. Diagnostic output

The diagnostic output is switched on in the event of a fault (switch-on condition as for DIA LED).

6.3. Limit-range monitoring

If the safety door with the actuator should settle over time, the actuator can drift out of the read head actuating range. The device recognizes this situation and indicates that the actuator is in the limit range by flashing the STATE LED. This allows the safety door to be readjusted in time. See also chapter 10. *System status table CES-I-AR-... on page 26.*

6.4. Switching states

The detailed switching states for your switch can be found in the system status table (see chapter 10. *System status table CES-I-AR-... on page 26*). All safety outputs, monitoring outputs and display LEDs are described there.

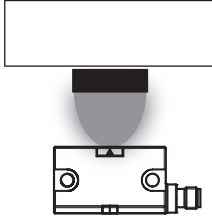
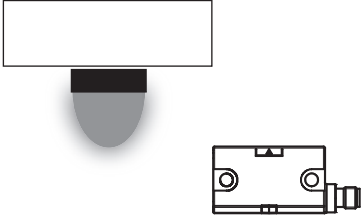
	Guard closed (actuator in the actuating range and permissible code detected)	Guard open (actuator not in the actuating range)
		
Safety outputs FO1A and FO1B	on	off
Monitoring output OD	on	off

7. Mounting



CAUTION

Safety switches must not be bypassed (bridging of contacts), turned away, removed or otherwise rendered ineffective.

- › Observe EN ISO 14119:2025, section 8, for information about reducing the possibilities for bypassing an interlocking device.



NOTICE

Risk of damage to equipment and malfunctions as a result of incorrect installation.

- › Safety switches and actuators must not be used as an end stop.
- › Observe EN ISO 14119:2025, sections 6.2 and 6.3, for information about mounting the safety switch and the actuator.
- › From the assured release distance S_{ar} , the safety outputs are safely shut down.
- › When mounting several safety switches/actuators, observe the stipulated minimum distance to avoid mutual interference.

CES-I-AR-.-C04-...

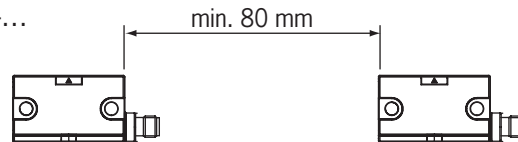

CES-I-AR-.-C14-...

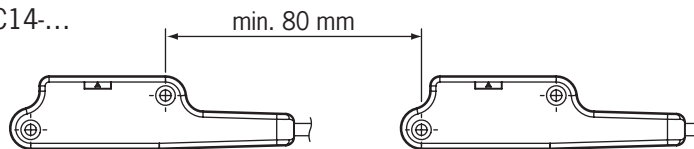

- › The operating distances change during the mounting of the actuator as a function of the material used for the guard.
- › Observe direction of arrow on the device (see figure below).

Permissible installation positions

CES-I-AR-.-C04-...

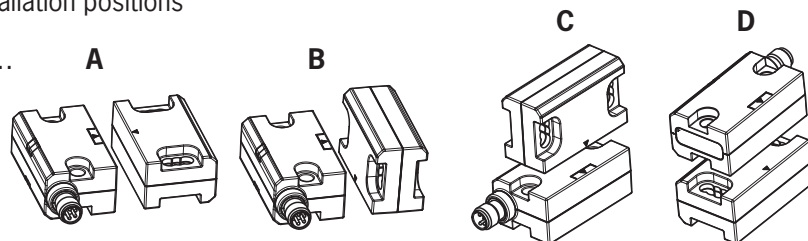

CES-I-AR-.-C14-...



Note the following points:

- › Actuator and safety switch must be easily accessible for inspection and replacement.
- › Actuator and safety switch must be fitted so that
 - the front faces are at the minimum operating distance $0.8 \times S_{a0}$ or closer when the guard is closed (see chapter 11. *Technical data*, sections *Operating distances* and *Typical operating distance* of the respective actuator). To avoid entering the area of possible side lobes, a minimum distance is to be maintained in case of a side approach direction. See chapter 11. *Technical data*, section *Typical operating distance* for the related actuator.
 - when the guard is open up to the distance S_{ar} (assured release distance), a hazard is excluded.
 - the actuator is positively mounted on the guard, e.g. by using the safety screws included.
 - the safety screws cannot be removed or tampered with using simple means.
- › Pay attention to the maximum tightening torque for the safety switch and actuator mountings:
 - CES-I-AR-.-C04-.../CES-A-BBN-C04-115271 0.8 Nm
 - CES-A-BBN-161502 1.0 Nm
 - CES-I-AR-.-C14-.../CES-A-BBN-C14-160441 2.0 Nm ¹⁾
- › In order to avoid damage, the connecting cable must be laid with protection in areas in which high-pressure cleaners are used.

¹⁾ To prevent the threaded connection from loosening, effective screw locking must be provided in addition to the tightening torque.

8. Electrical connection

The following connection options are available:

- › Separate operation
- › Series connection with Y-distributors or the passive distribution module AC-DP-...-SA-... from EUCHNER (only with M12 plug connector)
- › Series connection, e.g. with wiring in the control cabinet
- › Operation on an AR evaluation unit.



WARNING

In the event of a fault, loss of the safety function due to incorrect connection.

- › To ensure safety, both safety outputs must always be evaluated.
- › Monitoring outputs must not be used as safety outputs.
- › Lay the connecting cables with protection to prevent the risk of short circuits.



CAUTION

Risk of damage to equipment or malfunctions as a result of incorrect connection.

- › Do not use a control system with pulsing or switch off the pulsing function in your control system. The device generates its own test pulses on the safety outputs. A downstream control system must tolerate these test pulses, which may have a length of up to 1 ms. The test pulses are also output when the safety outputs are switched off. Depending on the inertia of the downstream device (control system, relay, etc.), this can lead to short switching processes.
- › The inputs on a connected evaluation unit must be positive switching, as the two outputs on the safety switch deliver a level of +24 V in the switched-on state.
- › All the electrical connections must either be isolated from the mains supply by a safety transformer according to IEC 61558-2-6 with limited output voltage in the event of a fault, or by other equivalent insulation measures (PELV).
- › All electrical outputs must have an adequate protective circuit for inductive loads. The outputs must be protected with a free-wheeling diode for this purpose. Varistors and RC interference suppression units must not be used.
- › Power devices which are a powerful source of interference must be installed in a separate location away from the input and output circuits for signal processing. The cable routing for safety circuits should be as far away as possible from the cables of the power circuits.
- › To avoid EMC interference, the physical environmental and operating conditions at the installation site of the device must comply with the requirements according to the standard IEC 60204-1 (EMC).
- › Pay attention to any interference fields from devices such as frequency converters or induction heating systems. Observe the EMC instructions in the manuals from the respective manufacturer.



Important!

If the device does not appear to function when operating voltage is applied (e.g. green STATE LED does not flash), the safety switch must be returned unopened to the manufacturer.

8.1. Notes on



Important!

- › This device is intended to be used with a Class 2 power source in accordance with UL1310. As an alternative an LV/C (Limited Voltage/Current) power source with the following properties can be used:
 - This device shall be used with a suitable isolating source in conjunction with a fuse in accordance with UL248. The fuse shall be rated max. 3.3 A and be installed in the max. 30 V DC power supply to the device in order to limit the available current to comply with the UL requirements. Please note possibly lower connection ratings for your device (refer to the technical data).
- › For use and application as per the requirements of ¹⁾ a connecting cable listed under the UL category code CYJV2 or CYJV must be used.

1) Note on the scope of the UL approval: only for applications as per NFPA 79 (Industrial Machinery). The devices have been tested as per the requirements of UL508 and CSA/ C22.2 no. 14 (protection against electric shock and fire).

8.2. Safety in case of faults

- › The operating voltage U_B is reverse polarity protected.
- › The safety outputs are short circuit-proof.
- › A short circuit between the safety outputs is detected by the switch.
- › A short circuit in the cable can be excluded by laying the cable with protection.

8.3. Fuse protection for power supply

The power supply must be provided with fuse protection depending on the number of switches and the current required for the outputs. The following rules apply:

Max. current consumption of an individual switch I_{max}

$$I_{max} = I_{UB} + I_{OD} + I_{F01A+F01B}$$

$$I_{UB} = \text{Switch operating current (35 mA)}$$

$$I_{OD} = \text{Load current of monitoring outputs (max. 50 mA)}$$

$$I_{F01A+F01B} = \text{Load current of safety outputs F01A + F01B (2 x max. 200 mA)}$$

Max. current consumption of a switch chain ΣI_{max}

$$\Sigma I_{max} = I_{F01A+F01B} + n \times (I_{UB} + I_{OD})$$

$$n = \text{Number of connected switches}$$

8.4. Requirements for connecting cables



CAUTION

Risk of damage to equipment or malfunctions as a result of incorrect connecting cables.

- › Use connection components and connecting cables from EUCHNER.
- › If other connection components are used, the requirements in the following table apply. EUCHNER provides no warranty for safe function in case of failure to comply with these requirements.
- › Observe the maximum cable length of 200 m.

Observe the following requirements with respect to the connecting cables:

Parameter	Value				Unit
	M12 / 8-pin	M8 / 8-pin	M12 / 5-pin	M12 / 5-pin	
Recommended cable type	LIYY 8 x 0.25	LIYY 8 x 0.14	LIYY 5 x 0.25	LIYY 5 x 0.34	mm ²
Cable	8 x 0.25	8 x 0.14	5 x 0.25	5 x 0.34	mm ²
Cable resistance R max.	78	57	78	58	Ω/km
Inductance L max.	0.51	0.57	0.64	0.53	mH/km
Capacitance C max.	107	102	60	100	nF/km

8.5. Maximum cable lengths

Switch chains are permitted up to a maximum overall cable length of 200 m taking into account the voltage drop as a result of the cable resistance (see table below with example data and case example).

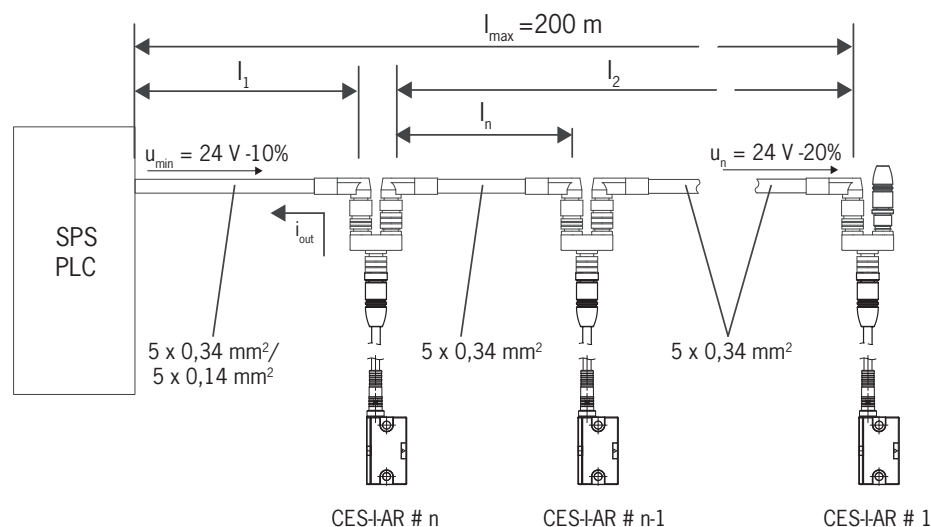

n Max. number of switches	I _{od} (mA) Possible output current per channel F01A/F01B	l ₁ (m) Max. cable length from the last switch to the control system	
		0.14 mm ²	0.34 mm ²
5	10	70	140
	25	50	110
	50	35	80
	100	25	50
	200	13	25
6	10	60	120
	25	50	90
	50	35	70
	100	20	50
	200	13	25
10	10	35	70
	25	30	60
	50	25	50
	100	15	35
	200	10	20

8.5.1. Determining cable lengths using the example table

Example: 6 switches are to be used in series. Cabling with a length of 40 m is routed from a safety relay in the control cabinet to the last switch (#6). Cables with a length of 20 m each are connected between the individual safety switches.

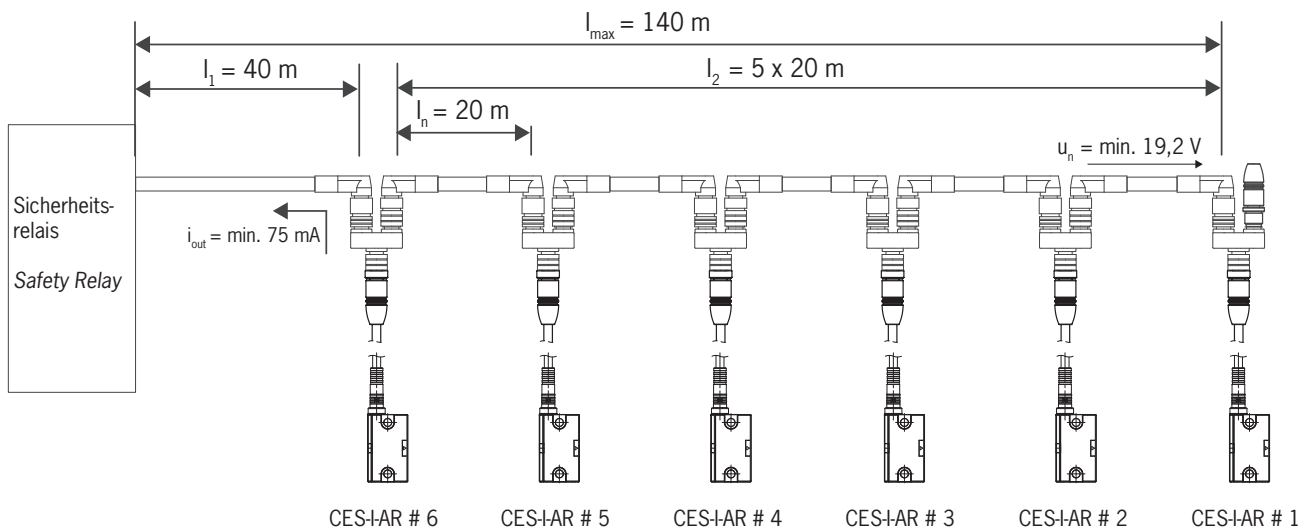

Fig. 1: Circuit example with six CES-I-AR

A safety relay is connected downstream that consumes 75 mA of current at each of the two safety inputs. It operates over the whole temperature range with a voltage of 19.2 V (corresponds to 24 V - 20%).

All the relevant values can now be determined using the example table:

1. Select the corresponding section in the column n (max. number of switches). In this case: 6 switches.
 2. In column I_{OD} (possible output current per channel FO1A/FO1B), find a current greater than or equal to 75 mA. In this case: 100 mA.
- ➔ It is then possible to determine the maximum cable length from the last switch (#6) to the control system from column l_1 . In this case, a length of 50 m is permitted.

Result: The desired cable length l_1 of 40 m is below the permitted value from the table. The overall length of the switch chain l_{max} of 140 m is less than the maximum value of 200 m.

- ➔ The planned application is therefore functional in this form.

8.6. Connector assignment of safety switch CES-I-AR-.C04

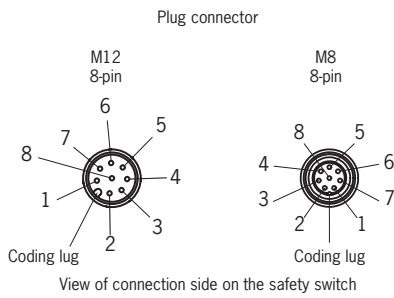

Fig. 2: Connector assignment of safety switch CES-I-AR

Pin	Designation	Description	Conductor coloring
1	F11B	Enable input for channel B	WH
2	UB	Power supply, DC 24 V	BN
3	FO1A	Safety output, channel A	GN
4	FO1B	Safety output, channel B	YE
5	OD	Monitoring output	GY
6	F11A	Enable input for channel A	PK
7	OV	Ground, DC 0 V	BU
8	RST	Reset input	RD

8.7. Terminal assignment of safety switch CES-I-AR-.C14

Designation	Description	Conductor coloring
F11B	Enable input for channel B	WH
UB	Power supply, DC 24 V	BN
FO1A	Safety output, channel A	GN
FO1B	Safety output, channel B	YE
OD	Monitoring output	GY
F11A	Enable input for channel A	PK
OV	Ground, DC 0 V	BU
RST	Reset input	RD

8.8. Connector assignment for Y-distributor

Connector assignment of safety switch CES-I-AR (8-pin plug) and Y-distributor (8-pin socket)

Pin	Function
X1.1	F11B
X1.2	U _B
X1.3	FO1A
X1.4	FO1B
X1.5	OD
X1.6	F11A
X1.7	0 V
X1.8	RST

Strapping plug 097645
4-pin, plug
(figure similar)

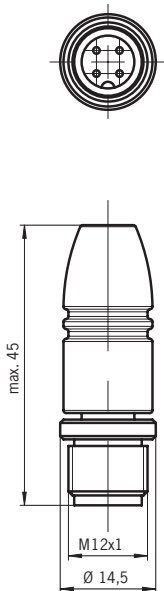

Y-distributor with connecting cable 111696 or 112395

Socket

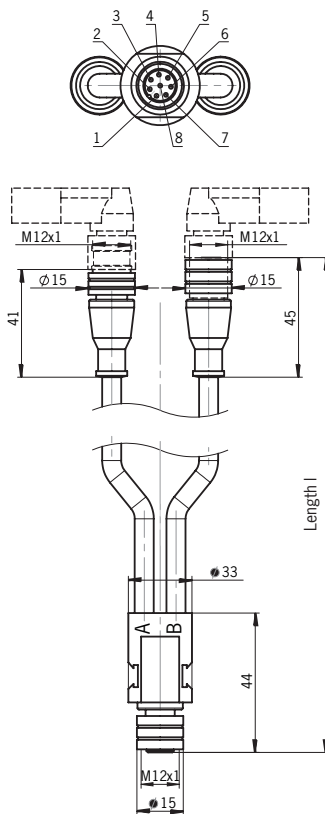

Order no.	Length l [mm]
111696	200
112395	1,000

Y-distributor 097627

Socket

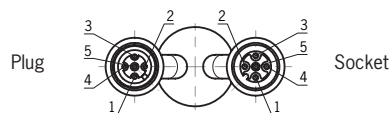
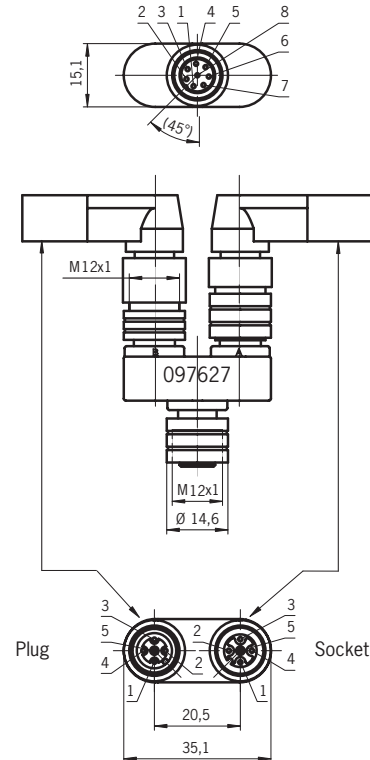

Pin	Function	Pin	Function
X2.1	U _B	X3.1	U _B
X2.2	FO1A	X3.2	F11A
X2.3	0 V	X3.3	0 V
X2.4	FO1B	X3.4	F11B
X2.5	RST	X3.5	RST

Pin	Function	Pin	Function
X2.1	U _B	X3.1	U _B
X2.2	FO1A	X3.2	F11A
X2.3	0 V	X3.3	0 V
X2.4	FO1B	X3.4	F11B
X2.5	RST	X3.5	RST

8.9. Connection of a single AR device

If a single AR device is used, connect the device as shown in Fig. 3. Monitoring outputs can be routed to a control system. The switch can be reset via the RST input. To do this, a voltage of 24 V is applied to the RST input for at least 3 seconds. The RST input must be connected to 0 V if it is not used.



WARNING

In the event of a fault, loss of the safety function due to incorrect connection.
 › To ensure safety, both safety outputs (FO1A and FO1B) must always be evaluated.



Important!

The example shows only an excerpt that is relevant for the connection of the CES system. The example illustrated here does not show complete system planning. The user is responsible for safe integration into the overall system. Detailed application examples can be found at www.euchner.com. Simply enter the order number of your switch in the search box. You will find all available connection examples for the device in *Downloads*.

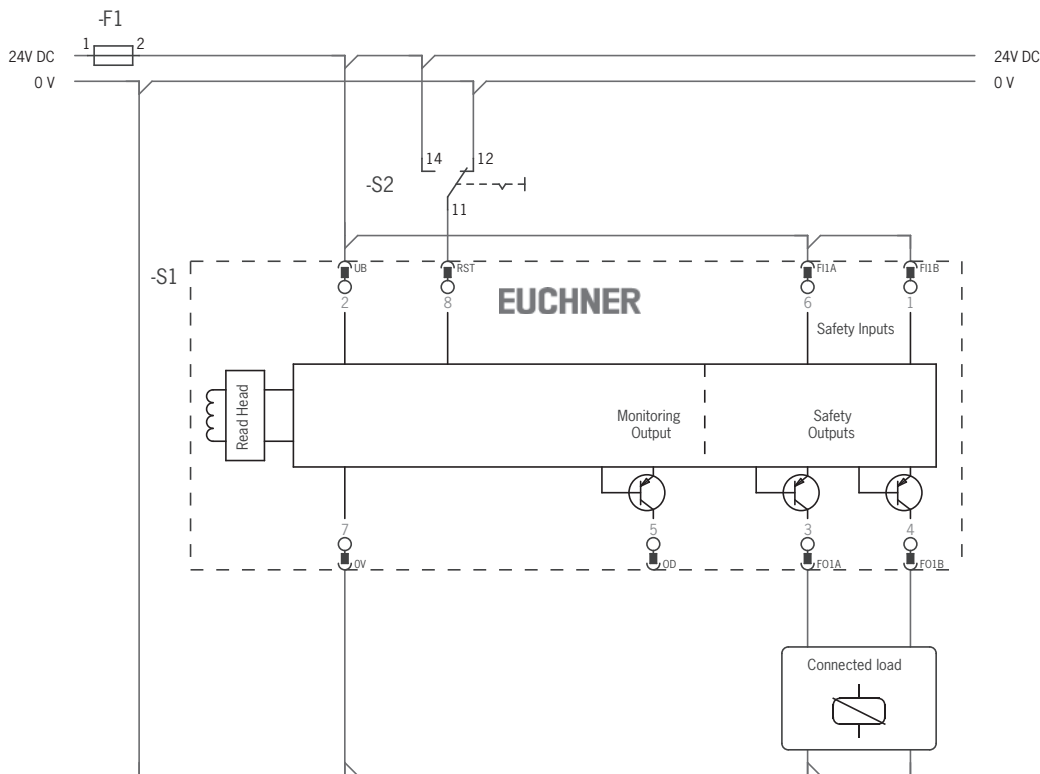

Fig. 3: Connection example for separate operation of a CES-I-AR...

8.10. Connection of several devices in a switch chain



Important!

- › An AR switch chain may contain a maximum of 20 safety switches.
- › The example shows only an excerpt that is relevant for the connection of the CES system. The example illustrated here does not show complete system planning. The user is responsible for safe integration into the overall system. Detailed application examples can be found at www.euchner.com. Simply enter the order number of your switch in the search box. You will find all available connection examples for the device in Downloads.

The series connection is shown here based on the example of the version with plug connector M12. The switches are connected one behind the other with the aid of pre-assembled connecting cables and Y-distributors. If a safety door is opened or if a fault occurs on one of the switches, the system shuts down the machine. A higher-level control system cannot, however, detect which safety door is open or on which switch a fault has occurred with this connection technology. A special AR evaluation unit is required for this purpose (see chapter 8.11. *Notes on operation on an AR evaluation unit on page 22*).

The series connection can also be realized via additional terminals in a control cabinet.

The safety outputs are permanently assigned to the respective safety inputs of the downstream switch. FO1A must be routed to FI1A and FO1B to FI1B. If the connections are interchanged (e.g. FO1A to FI1B), the device will switch to the fault state.

Always use the RST input in series connections. All switches in a chain can be reset at the same time with this reset input. To do this, a voltage of 24 V must be applied to the RST input for at least 3 seconds. If the RST input is not used in your application, it must be connected to 0 V.

Note the following on this aspect:

- › A common signal must be used for all switches in the chain. This can be a changeover switch or the output of a control system. A pushbutton is not suitable because the reset must always be connected to GND during operation (see switch S1 in *Fig. 4 on page 21*).
- › Reset must always be performed simultaneously for all switches of the chain.

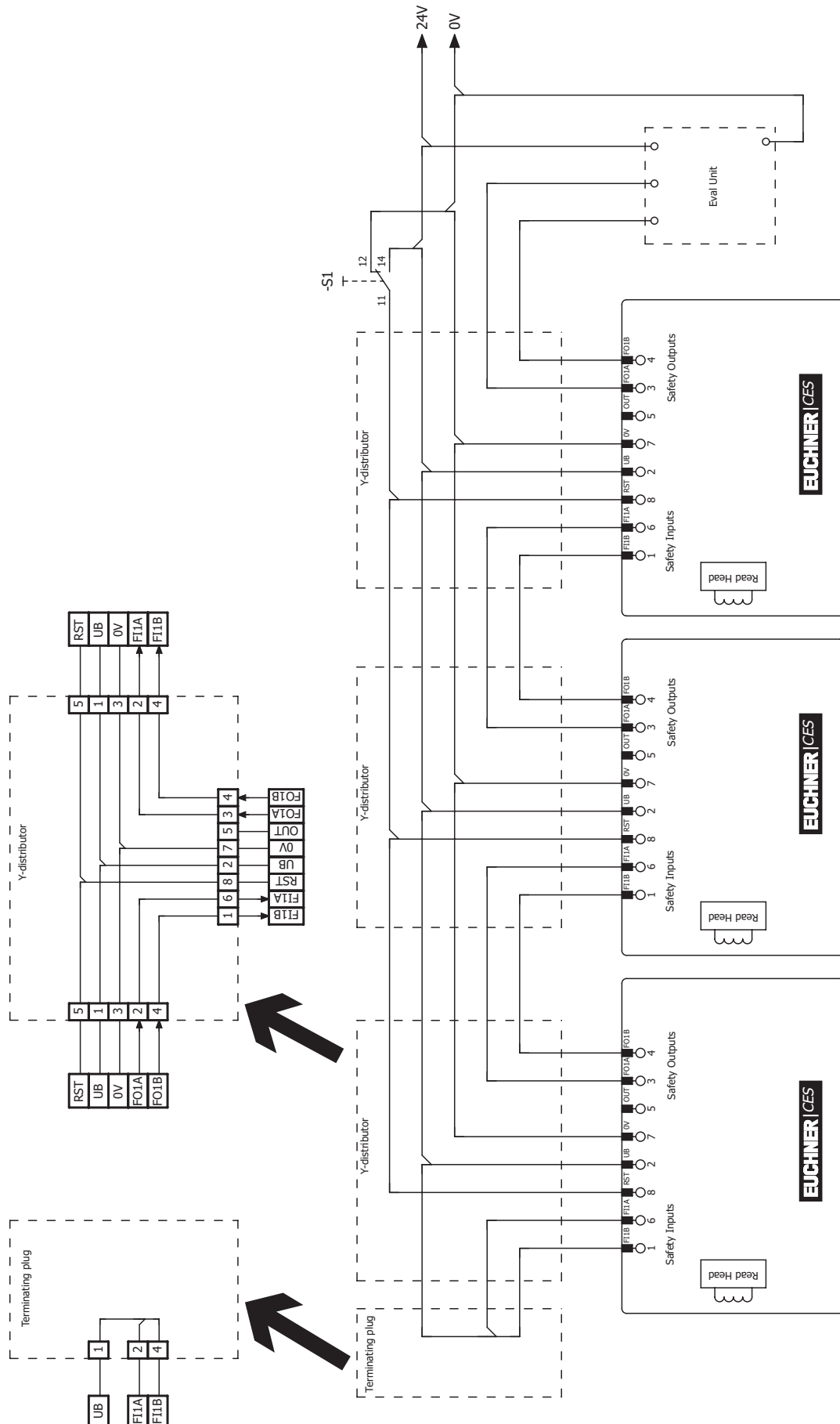

Fig. 4: Connection example for series connection with reset and changeover switch

8.11. Notes on operation on an AR evaluation unit

The devices can be operated on an AR evaluation unit. Refer to the operating instructions for the relevant AR evaluation unit for more information.

8.12. Notes on operation with safe control systems

Observe the following guidelines for connection to safe control systems:

- › Use a common power supply for the control system and the connected safety switches.
- › A pulsed power supply must not be used for U_B . Tap the supply voltage directly from the power supply unit. If the power supply is connected to a terminal of a safe control system, this output must provide sufficient electrical current.
- › Always connect inputs F11A and F11B directly to a power supply unit or to outputs FO1A and FO1B of another EUCHNER AR device (series connection). Pulsed signals must not be present at inputs F11A and F11B.
- › The safety outputs (FO1A and FO1B) can be connected to the safe inputs of a control system. Prerequisite: The input must be suitable for pulsed safety signals (OSSD signals, e.g. from light grids). The control system must tolerate test pulses on the input signals. This normally can be set up by parameter assignment in the control system. Observe the notes of the control system manufacturer. For the test pulse duration of your safety switch, refer to chapter 11. *Technical data on page 27.*

A detailed example of connecting and setting the parameters of the control system is available for many devices at www.euchner.com, in the area *Downloads/Applications/CES*. The features of the respective device are dealt with there in greater detail.

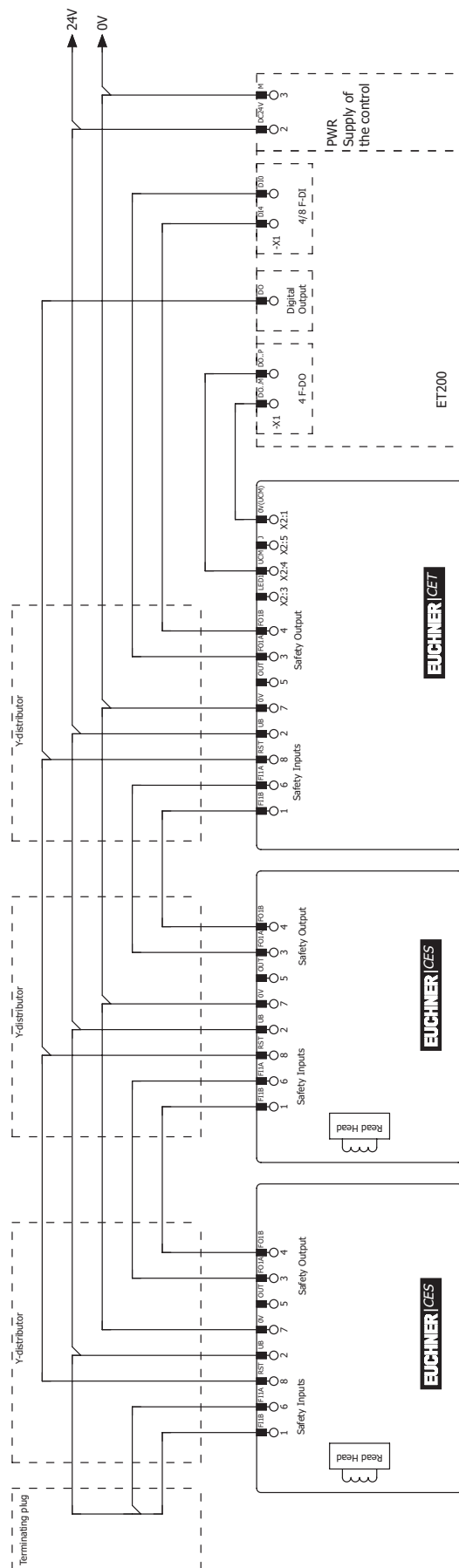

Fig. 5: Connection example for mixed series connection (2 x CES and 1 x CET) to ET200

9. Setup

9.1. LED displays

You will find a detailed description of the signal functions in chapter 10. *System status table CES-I-AR... on page 26.*

LED	Color
STATE	green
DIA	red

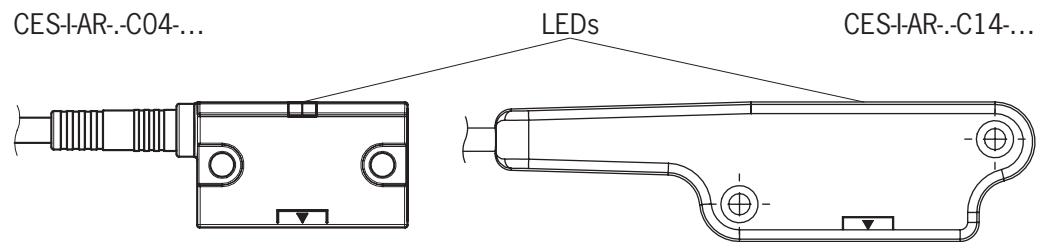

9.2. Teach-in function for actuator (only for unicode evaluation)

The actuator must be allocated to the safety switch using a teach-in function before the system forms a functional unit.

During a teach-in operation, the safety outputs and the monitoring output OD are switched off, i.e. the system is in the safe state.



Tip!

It is recommended to perform the teach-in operation prior to mounting. Mark switches and actuators that belong together in order to avoid confusion. For devices to be connected in series, we recommend performing the teach-in operation separately for each device prior to series connection.



Important!

- › The teach-in operation may be performed only if the device functions flawlessly. The red DIA LED must not be illuminated.
- › The safety switch disables the code of the preceding device if teach-in is carried out for a new actuator. Teach-in is not possible again immediately for this device if a new teach-in operation is carried out. The disabled code is enabled again in the safety switch only after a third code has been taught-in.
- › The safety switch can be operated only with the last actuator taught-in.
- › The number of teach-in operations is unlimited.
- › After starting, the device remains in the teach-in standby state for 3 min. If no new actuator is detected in this time, the device changes to normal operation. If the switch detects the actuator that was most recently taught-in when in the teach-in standby state, this state is ended immediately and the switch changes to normal operation.
- › If the actuator to be taught-in is in the actuating range for less than 60 s, it will not be activated and the most recently taught-in actuator will remain saved.
- › After an unsuccessful teach-in operation, the switch changes to normal operation.

9.2.1. Preparing device for the teach-in operation and teaching-in actuator

1. Apply operating voltage to the safety switch.
 - ➔ The green LED flashes quickly (approx. 5 Hz)
A self-test is performed during this time (approx. 8 s). After this, the LED flashes cyclically three times and signals teach-in standby.
Teach-in standby state remains active for approx. 3 minutes.
2. Move new actuator to the read head (observe distance $< S_{a0}$).
 - ➔ Teach-in operation starts, green LED flashes (approx. 1 Hz). During the teach-in operation, the safety switch checks whether the actuator is a disabled actuator. If this is not the case, the teach-in operation is completed after approx. 60 seconds, the green LED goes out. The new code has been saved, the old code disabled.
3. To activate the new actuator code from the teach-in operation in the safety switch, the operating voltage to the safety switch must then be switched off for min. 3 seconds.

9.2.2. Teach-in function with series connection, replacing and teaching-in device

It is recommended not to teach-in the actuators in the series connection but to teach them in one by one instead. Teach-in in a series connection works analogously to separate operation in principle. All switches in the chain can be taught-in at the same time. The prerequisite is that the switch chain functions without problems and the following steps are followed. Further steps might have to be observed for mixed switch chains (e.g. for chains with CES and safety switches with guard locking). Observe the operating instructions for the other devices in the chain for this purpose.

Work on the wiring (e.g. during device replacement) should generally be performed in a de-energized state. On certain systems, it is nevertheless necessary to perform this work and subsequent teach-in during ongoing operation.

The RST input must be connected as shown in *Fig. 4 on page 21* to permit this.

Proceed as follows:

1. Open the guard on which the switch or actuator is to be replaced.
2. Mount the new switch or actuator and prepare it for the teach-in operation (see chapter 9.2.1. *Preparing device for the teach-in operation and teaching-in actuator on page 24*).
3. Close all guards in the chain.
4. Actuate the reset for at least 3 s (24 V on RST).
 - ➔ On the safety switch that is positioned at a new actuator, the green LED flashes at approx. 1 Hz and the actuator is taught-in. This takes approx. 1 min. Do not switch off during this time and do not actuate reset! The teach-in operation has ended when all LEDs on the device are off.
5. Actuate the reset for at least 3 s (24 V on RST).
 - ➔ The system restarts and then continues to function in normal operation.

9.3. Functional check



WARNING

- Danger of fatal injury as a result of faults in installation and the functional check.
- › Before carrying out the functional check, make sure that there are no persons in the danger area.
 - › Observe the valid accident prevention regulations.



















9.3.1. Electrical function test

After installation and any fault, the safety function must be fully checked. Proceed as follows:

1. Switch on operating voltage.
 - ➔ The machine must not start automatically.
 - ➔ The safety switch carries out a self-test. The green STATE LED flashes for 8 s at 5 Hz. The green STATE LED then flashes at regular intervals.
2. Close all guards.
 - ➔ The machine must not start automatically.
 - ➔ The green STATE LED illuminates continuously.
3. Enable operation in the control system.
4. Open the guard.
 - ➔ The machine must switch off and it must not be possible to start it as long as the guard is open.
 - ➔ The green STATE LED flashes at regular intervals.

Repeat steps 2 - 4 for each guard.

10. System status table CES-I-AR-...

Operating mode	Actuator/door position	Safety outputs FO1A and FO1B	Monitoring output OD	LED indicator Output		State
				STATE (green)	DIA (red)	
Self-test	X	off	off	 5 Hz (8 s)	○	Self-test after power-up
Normal operation	closed	on	on		○	Normal operation, door closed, safety outputs on the preceding device in the switch chain switched on
	closed	on	on	 Flash burst inverted 5 x	○	Normal operation, door closed, actuator in the limit range → Re-adjust door
	closed	off	on	 1 x inverse	○	Normal operation, door closed, safety outputs on the preceding device in the switch chain switched off
	open	off	off	 1 x	○	Normal operation, door open, actuator already taught-in
	open	off	off	 2 x	○	No actuator taught-in, teach-in operation not completed successfully
Teach-in operation (only unicode)	open	off	off	 3 x	○	- Door open, device is ready for teach-in for another actuator (only short time after power-up). - Switches that have not been taught-in remain in teach-in standby until the teach-in operation starts.
	closed	off	off	 1 Hz	○	Teach-in operation
	X	off	off	○	○	Positive acknowledgment after completion of teach-in operation
Fault display	X	off	off	 2 x		Input fault (e.g. missing test pulses, illogical switching state from preceding device in the switch chain)
	closed	off	off	 3 x		Defective actuator (e.g. error in code or code not readable)
	X	off	off	 4 x		Output fault (e.g. short circuits, loss of switching ability)
	X	off	off	○		Internal fault (e.g. component fault, data error)
Key to symbols				○		LED not illuminated
						LED illuminated
				 5 Hz (8 s)		LED flashes for 8 seconds at 5 Hz
				 3 x		LED flashes three times, cycle time 7 s
				X		Any state

After the cause has been remedied, faults can generally be reset by opening and closing the guard. If the fault is still displayed afterward, use the reset function or briefly interrupt the power supply. Contact the manufacturer if the fault could not be reset after restarting.



Important!

If you do not find the displayed device status in the system status table, this indicates an internal device fault. In this case, you should contact the manufacturer.

11. Technical data



NOTICE

If a data sheet is available for the product, the information on the data sheet applies.

11.1. Technical data for safety switch CES-I-AR-C04-...

Parameter	Value			Unit
	min.	typ.	max.	
Housing material	PBT plastic			
Dimensions	42 x 25 x 18			mm
Ambient temperature at $U_B = DC 24 V$				°C
- with plug connector	- 25	-	+ 65	
- with connecting cable	- 30	-	+ 65	
Degree of protection	IP67 IP69K (only version with plug connector M8 and mating connector with the same degree of protection)			
Safety class	III			
Degree of contamination	3			
Installation position	Any			
Mounting method	Surface mounting on metal			
Connection	<ul style="list-style-type: none"> - Plug connector M8, 8-pin, or - Plug connector M12, 8-pin, or - Connecting cable PUR, 0.25 mm², with plug connector M12, 8-pin, or - Connecting cable PUR with flying lead, 8 x 0.14 mm² 			
Operating voltage U_B (regulated, residual ripple < 5%)	24 ± 15% (PELV)			V DC
Current consumption	-	-	35	mA
External fuse (operating voltage)	0.25	-	8	A
Safety outputs FO1A/FO1B	2 semiconductor outputs, p-switching, short circuit-proof			
- Output voltage $U(FO1A)/U(FO1B)$ ¹⁾				
HIGH $U(FO1A)$	$U_B - 1.5$	-	U_B	V DC
HIGH $U(FO1B)$				
LOW $U(FO1A)/U(FO1B)$	0		1	
Switching current per safety output	1	-	200	mA
Utilization category acc. to EN IEC 60947-5-2	DC-13 24 V 200 mA Caution: Outputs must be protected by a free-wheeling diode in the case of inductive loads.			
Off-state current I_r ²⁾	-	-	0.25	mA
Monitoring output OD ¹⁾	Semiconductor output, p-switching, short circuit-proof			
- Output voltage	$0.8 \times U_B$	-	U_B	V DC
- Max. load	-	-	50	mA
Rated insulation voltage U_i	75			V
Rated impulse withstand voltage U_{imp}	1.5			kV
Conditional short-circuit current	100			A
Shock and vibration resistance	Acc. to EN IEC 60947-5-3			
Switching frequency	-	-	1	Hz
Repeat accuracy R	≤ 10			%
EMC protection requirements	Acc. to EN IEC 60947-5-3			
Ready delay	-	10	-	s
Risk time acc. to EN IEC 60947-5-3	-	-	260	ms
Risk time acc. to EN IEC 60947-5-3, extension for each additional device	-	-	5	ms
Turn-on time	-	-	400	ms
Discrepancy time	-	-	10	ms
Test pulse duration	1			ms
Test pulse interval	140	-	-	ms
Characteristics acc. to EN ISO 13849-1				
Category	4			
Performance Level	PL e			
PFH	4.1×10^{-9}			
Mission time	20			years

1) Values at a switching current of 50 mA without taking into account the cable lengths.

2) Maximum current at an output in switched-off state.

11.1.1. Dimension drawing for safety switch CES-I-AR-C04-...

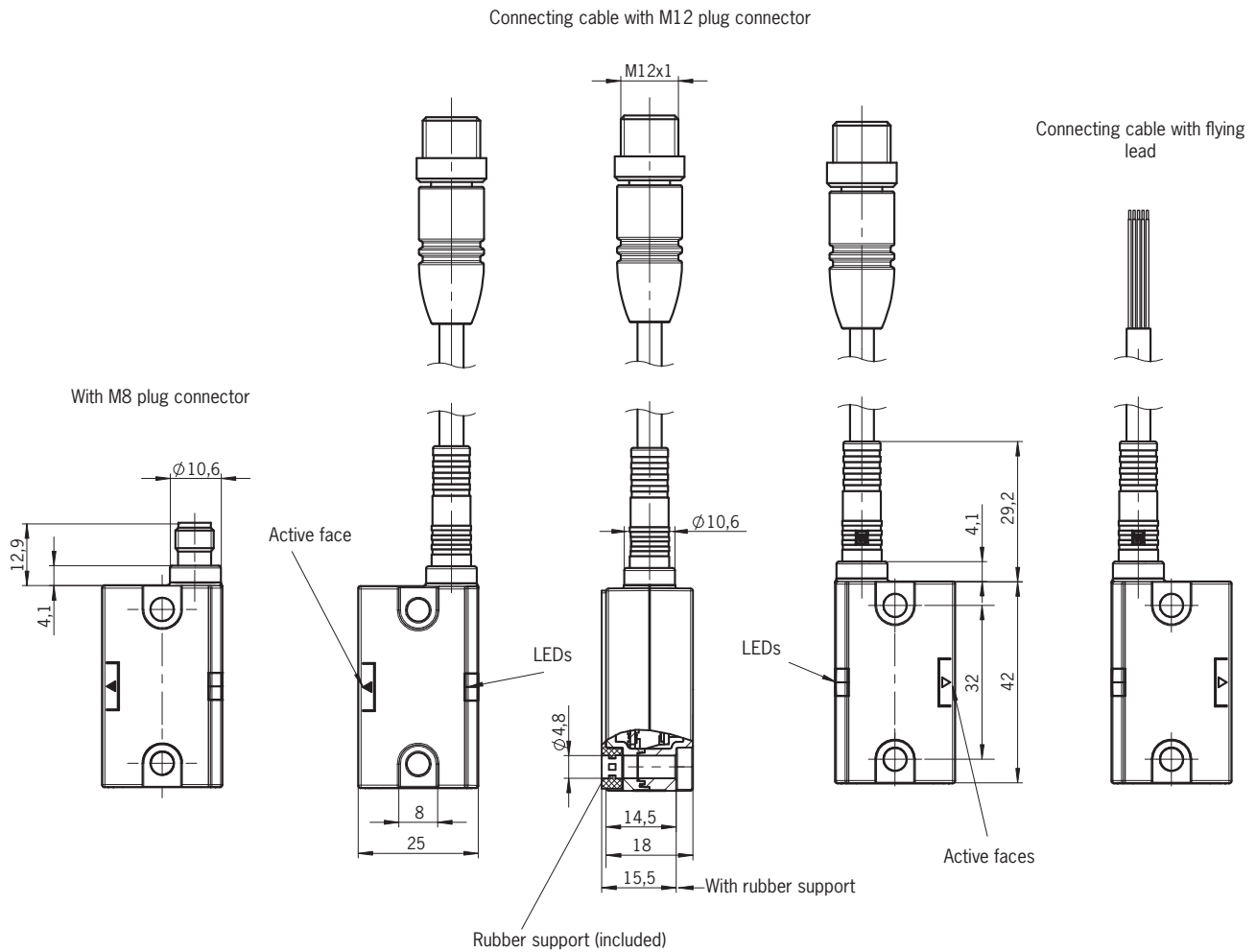

11.2. Technical data for safety switch CES-I-AR-.C14-...

Parameter	Value			Unit
	min.	typ.	max.	
Housing material	Two-component epoxy resin			
Dimensions	116 x 30 x 23			
Ambient temperature at $U_B = DC\ 24\ V$	0	-	+ 65	°C
Degree of protection	IP65/IP67/IP69/IP69K			
Safety class	III			
Degree of contamination	3			
Installation position	Any			
Mounting method	Surface mounting on metal			
Connection	Connecting cable PUR with flying lead, 8 x 0.14 mm ² , length 20 m			
Operating voltage U_B (regulated, residual ripple < 5%)	24 ± 15% (PELV)			V DC
Current consumption	-	-	35	mA
External fuse (operating voltage)	0.25	-	8	A
Safety outputs FO1A/FO1B	2 semiconductor outputs, p-switching, short circuit-proof			
- Output voltage $U(F01A)/U(F01B)$ ¹⁾				
HIGH $U(F01A)$	$U_B - 1.5$	-	U_B	V DC
HIGH $U(F01B)$				
LOW $U(F01A)/U(F01B)$		0		
Switching current per safety output	1	-	200	mA
Utilization category acc. to EN IEC 60947-5-2	DC-13 24 V 20 mA Caution: Outputs must be protected by a free-wheeling diode in the case of inductive loads.			
Off-state current I_r ²⁾	-	-	0.25	mA
Monitoring output ¹⁾	Semiconductor output, p-switching, short circuit-proof			
- Output voltage	$0.8 \times U_B$	-	U_B	V DC
- Max. load	-	-	50	mA
Rated insulation voltage U_i	75			V
Rated impulse withstand voltage U_{imp}	1.5			kV
Shock and vibration resistance	Acc. to EN IEC 60947-5-3			
Switching frequency	-	-	1	Hz
Repeat accuracy R acc. to EN IEC 60947-5-2	≤ 10			%
EMC protection requirements	Acc. to EN IEC 60947-5-3			
Ready delay	-	10	-	s
Risk time acc. to EN IEC 60947-5-3	-	-	260	ms
Risk time acc. to EN IEC 60947-5-3, extension for each additional device	-	-	5	ms
Turn-on time	-	-	400	ms
Discrepancy time	-	-	10	ms
Test pulse duration	1			ms
Test pulse interval	140	-	-	ms
Characteristics acc. to EN ISO 13849-1				
Category	4			
Performance Level	PL e			
PFH	4.1×10^{-9}			
Mission time	20			years

1) Values at a switching current of 50 mA without taking into account the cable lengths.

2) Maximum current at an output in switched-off state.

11.2.1. Dimension drawing for safety switch CES-I-AR-C14-...

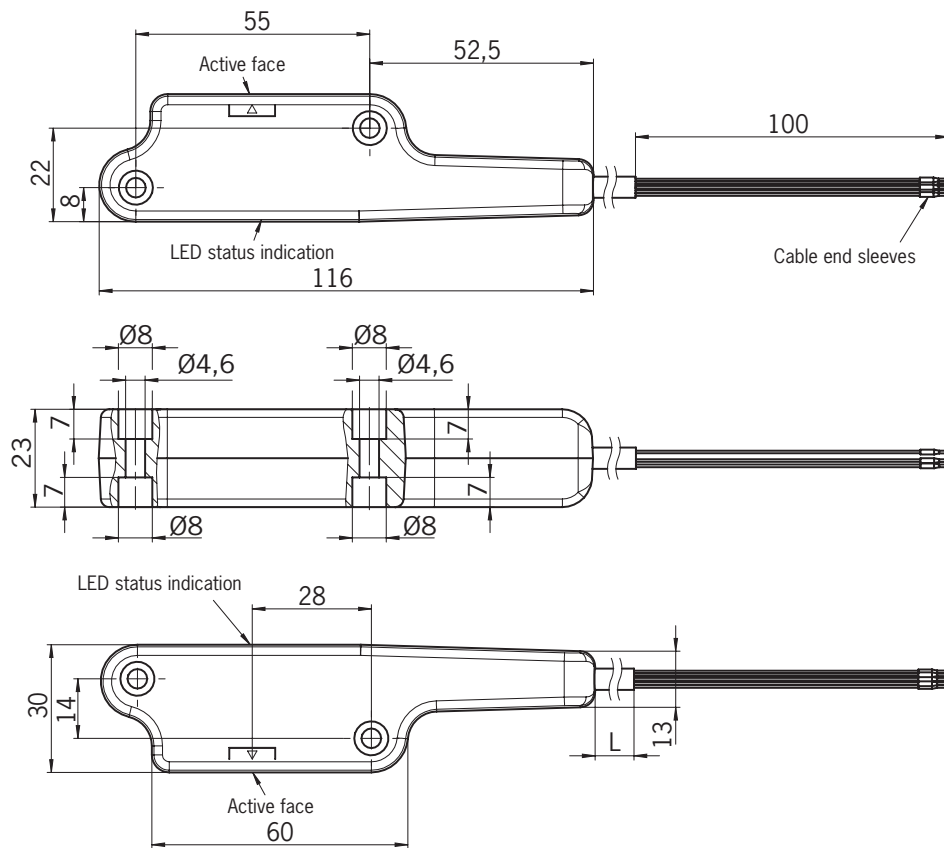

11.3. Typical system times

Refer to the technical data for the exact values.

Ready delay: After switch-on, the device carries out a self-test. The system is ready for operation only after this time.

Turn-on time of safety outputs: The max. reaction time t_{on} is the time from the moment when the actuator is in the actuating range to the moment when the safety outputs switch on.

Simultaneity monitoring of safety inputs F11A/F11B: If the safety inputs have different switching states over a certain time, the safety outputs (FO1A and FO1B) will be switched off. The device enters the fault state.

Risk time according to EN IEC 60947-5-3: If an actuator moves outside the actuating range, the safety outputs (FO1A and FO1B) are switched off after the risk time at the latest.

If several devices are operated in a series connection, the risk time of the overall device chain will increase with each device added. Use the following calculation formula:

$$t_r = t_{r,e} + (n \times t_d)$$

t_r = Total risk time

$t_{r,e}$ = Risk time for single device (see technical data)

t_d = Risk time delay per device

n = Number of additional devices (total number -1)

Discrepancy time: The safety outputs (FO1A and FO1B) switch with a slight time offset. They have the same signal state no later than after the discrepancy time.

Test pulses at the safety outputs: The device generates its own test pulses on the safety outputs (FO1A and FO1B). A downstream control system must tolerate these test pulses.

This can usually be set up in the control systems by parameter assignment. If parameter assignment is not possible for your control system or if shorter test pulses are required, contact our support organization.

The test pulses are also output when the safety outputs are switched off.

11.4. Technical data for actuator CES-A-BBN-C04

Parameter	Value			Unit
	min.	typ.	max.	
Housing material	PBT plastic			
Dimensions	42 x 25 x 18			mm
Ambient temperature	- 25	-	+ 65	°C
Degree of protection	IP67/IP69K			
Installation position	Active face opposite read head			
Power supply	Inductive via read head			

11.4.1. Dimension drawing

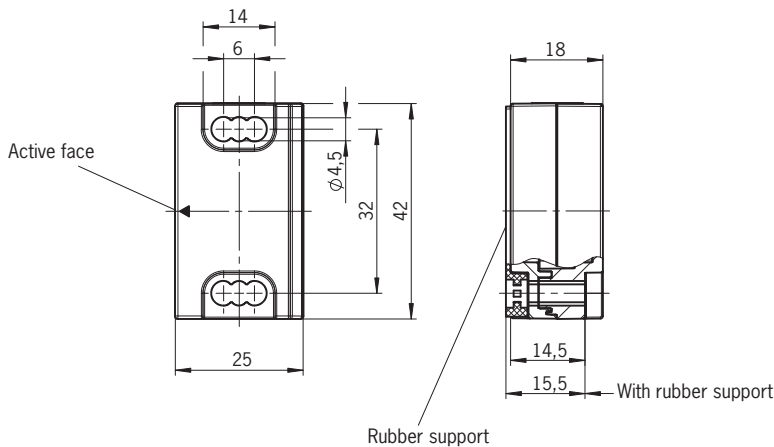

NOTICE

- › 2 safety screws M4x20 included.
- › Rubber support included.

11.4.2. Operating distances

Operating distance for center offset $m = 0$ (in combination with safety switch CES-C04)

Installation position		Parameter	Value			Unit
A	B		min.	typ.	max.	
		Operating distance ¹⁾	-	15	-	mm
		Assured operating distance s_{ao} ¹⁾	10	-	-	
		Switching hysteresis ¹⁾	1	2	-	
		Assured release distance s_{ar} - in x/z direction - in y direction	- -	- -	40 60	

1) On approach in z direction

Installation position		Parameter	Value			Unit
C	D		min.	typ.	max.	
		Operating distance ¹⁾	-	11	-	mm
		Assured operating distance s_{ao} ¹⁾	6	-	-	
		Switching hysteresis ¹⁾	1	2	-	
		Assured release distance s_{ar} - in x/z direction - in y direction	- -	- -	40 60	

1) On approach in x direction

Operating distance for center offset $m = 0$ (in combination with safety switch CES-C14)

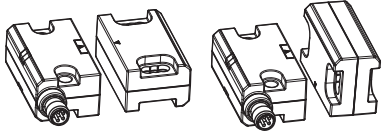
Installation position		Parameter	Value			Unit
A	B		min.	typ.	max.	
		Operating distance ¹⁾	-	12.5	-	mm
		Assured operating distance s_{ao} ¹⁾	7.5	-	-	
		Switching hysteresis ¹⁾	1	2	-	
		Assured release distance s_{ar} - in x/z direction - in y direction	- -	- -	37.5 57.5	

1) On approach in z direction

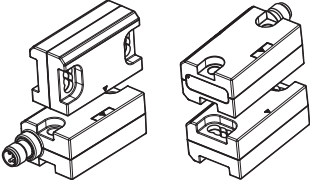
Installation position		Parameter	Value			Unit
C	D		min.	typ.	max.	
		Operating distance ¹⁾	-	8.5	-	mm
		Assured operating distance s_{ao} ¹⁾	3.5	-	-	
		Switching hysteresis ¹⁾	1	2	-	
		Assured release distance s_{ar} - in x/z direction - in y direction	- -	- -	37.5 57.5	

1) On approach in x direction

11.4.3. Typical operating distance in installation position A

(only in combination with actuator CES-A-BBN-C04 and safety switch CES-C04)

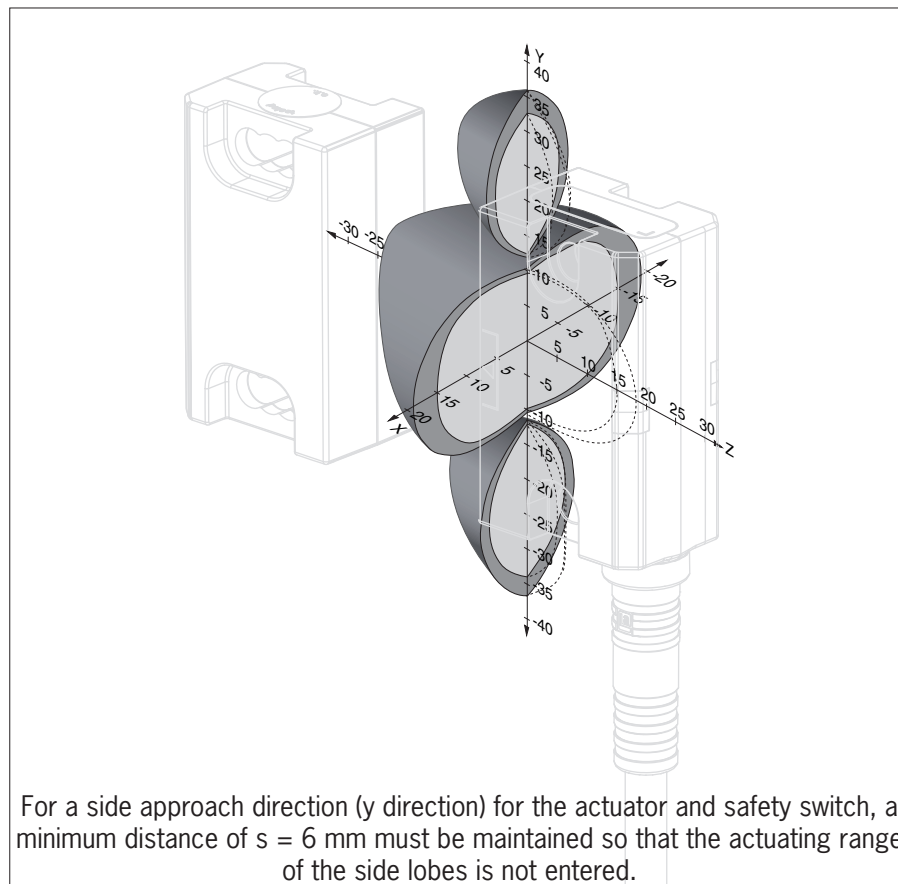
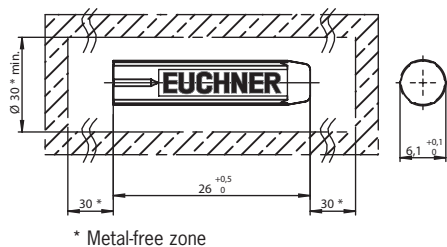

Fig. 6: Typical operating distance

11.5. Technical data for actuator CES-A-BDN-06-161742

Parameter	Value			Unit
	min.	typ.	max.	
Housing material	Macromelt PA-based plastic			
Dimensions	26 x Ø 6			mm
Ambient temperature	- 30	-	+ 70	°C
Degree of protection	IP65/IP67			
Installation position	Active face opposite read head			
Power supply	Inductive via read head			

11.5.1. Dimension drawing



CAUTION

- Do not mount at temperatures below 0 °C.
- The actuator can be damaged during mounting.

11.5.2. Operating distances

Operating distance for center offset $m = 0$

Installation position	Parameter	Value			Unit
		min.	typ.	max.	
A 	Operating distance	-	25	-	mm
	Assured operating distance s_{ao} ¹⁾	15	-	-	
	Switching hysteresis ¹⁾	-	2	-	
	Assured release distance s_{ar} - in x/z direction - in y direction	- -	- -	69 77	

1) The values apply only to surface mounting of the actuator in metal

Installation position	Parameter	Value			Unit
		min.	typ.	max.	
C 	Operating distance	-	20	-	mm
	Assured operating distance s_{ao} ¹⁾	10	-	-	
	Switching hysteresis ¹⁾	1	2	-	
	Assured release distance s_{ar} - in x/z direction - in y direction	- -	- -	64 72	

1) The values apply only to surface mounting of the actuator in metal

11.6. Technical data for actuator CES-A-BDN-06-161742

Parameter	Value			Unit
	min.	typ.	max.	
Housing material	Macromelt PA-based plastic			
Dimensions	38 x \varnothing 6			mm
Ambient temperature	- 30	-	+ 70	°C
Degree of protection	IP65/IP67			
Installation position	Active face opposite read head			
Power supply	Inductive via read head			

11.6.1. Dimension drawing

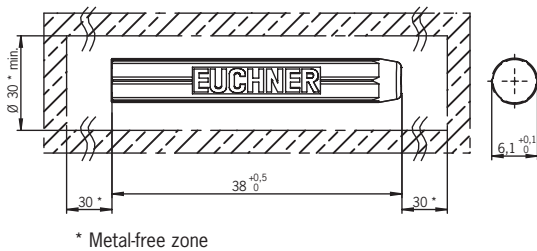

CAUTION

- › Do not mount at temperatures below 0 °C.
- › The actuator can be damaged during mounting.

11.6.2. Operating distances

Operating distance for center offset $m = 0$ (in combination with safety switch CES-C04)

Installation position	Parameter	Value			Unit
		min.	typ.	max.	
	Operating distance	-	25	-	mm
	Assured operating distance s_{ao} ¹⁾	15	-	-	
	Switching hysteresis ¹⁾	1	2	-	
	Assured release distance s_{ar} - in x/z direction - in y direction	- -	- -	69 77	

1) The values apply to mounting the actuator in non-metallic surroundings

Installation position	Parameter	Value			Unit
		min.	typ.	max.	
	Operating distance	-	20	-	mm
	Assured operating distance s_{ao} ¹⁾	10	-	-	
	Switching hysteresis ¹⁾	1	2	-	
	Assured release distance s_{ar} - in x/z direction - in y direction	- -	- -	64 72	

1) The values apply to mounting the actuator in non-metallic surroundings

11.7. Technical data for actuator CES-A-BBN-161502

Parameter	Value			Unit
	min.	typ.	max.	
Housing material	PBT plastic			
Dimensions	42 x 25 x 12			mm
Ambient temperature	- 30	-	+ 70	°C
Degree of protection	IP65/IP67			
Installation position	Active face opposite read head			
Power supply	Inductive via read head			

11.7.1. Dimension drawing

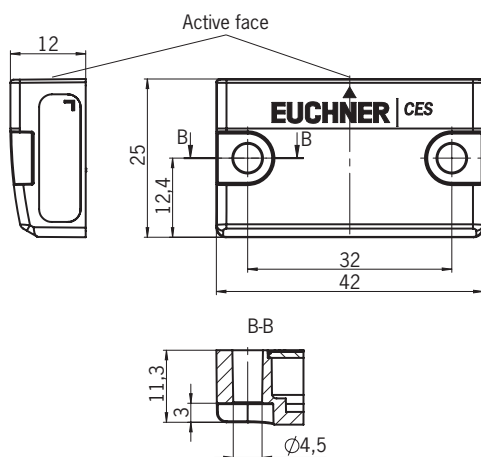

NOTICE

› 2 safety screws M4x14 included.

11.7.2. Operating distances

Operating distance for center offset $m = 0$ (in combination with safety switch CES-C04)

Installation position		Parameter	Value			Unit
A	B		min.	typ.	max.	
		Operating distance ¹⁾	-	25	-	mm
		Assured operating distance s_{ao} ¹⁾	15	-	-	
		Switching hysteresis ¹⁾	1	2	-	
		Assured release distance s_{ar} - in x/z direction - in y direction	- -	- -	69 77	

1) On approach in z direction

Installation position		Parameter	Value			Unit
C	D		min.	typ.	max.	
		Operating distance ¹⁾	-	20	-	mm
		Assured operating distance s_{ao} ¹⁾	10	-	-	
		Switching hysteresis ¹⁾	1	2	-	
		Assured release distance s_{ar} - in x/z direction - in y direction	- -	- -	64 72	

1) On approach in x direction

11.8. Technical data for actuator CES-A-BBN-C14-160441

Parameter	Value			Unit
	min.	typ.	max.	
Housing material	Two-component epoxy resin			
Dimensions	72 x 30 x 17			mm
Ambient temperature	0	-	+ 65	°C
Degree of protection	IP65/IP67/IP69/IP69K			
Installation position	Active face opposite read head			
Power supply	Inductive via read head			

11.8.1. Dimension drawing

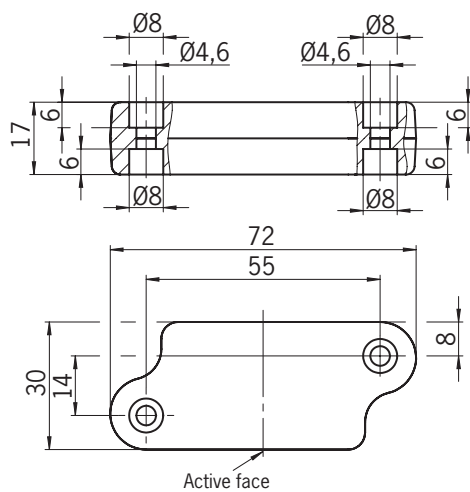

NOTICE

› 2 safety screws M4x16 included.

11.8.2. Operating distances

Operating distance for center offset $m = 0$ (in combination with safety switch CES-C14)

Installation position	Parameter	Value (ALU surroundings/PVC surroundings)			Unit
		min.	typ.	max.	
A					
	Operating distance ¹⁾	-	24	-	mm
	Assured operating distance s_{ao} ²⁾	10	-	-	
	Switching hysteresis ¹⁾	1	2	-	
	Assured release distance s_{ar} - in x/z direction - in y direction	- -	- -	64 72	

1) On approach in z direction

2) Values apply to ambient temperatures up to 50 °C

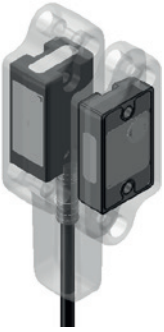
Installation position	Parameter	Value (ALU surroundings/PVC surroundings)			Unit
		min.	typ.	max.	
D					
	Operating distance ¹⁾	-	15	-	mm
	Assured operating distance s_{ao} ²⁾	5	-	-	
	Switching hysteresis ¹⁾	1	2	-	
	Assured release distance s_{ar} - in x/z direction - in y direction	- -	- -	60 68	

1) On approach in x direction

2) Values apply only to ambient temperatures up to 50 °C

11.8.3. Typical operating distance in installation position A

(only in combination with actuator CES-A-BBN-C14-160441)

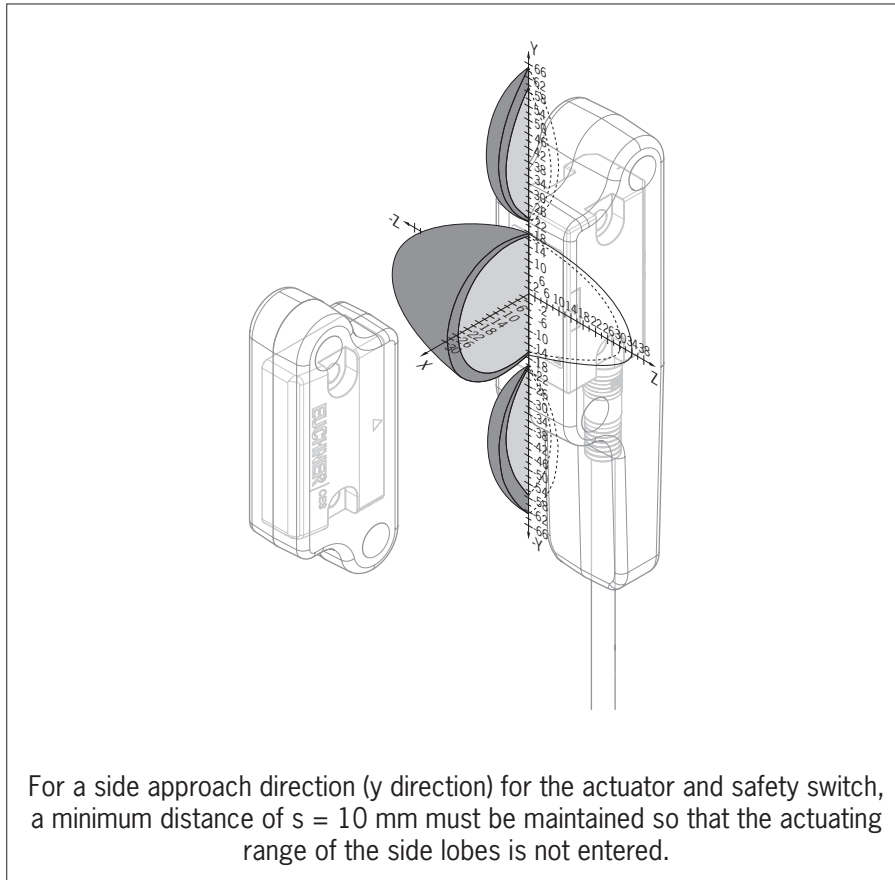

Fig. 7: Typical operating distance

12. Ordering information and accessories



Tip!

Suitable accessories, e.g. cables or assembly material, can be found at www.euchner.com. To order, enter the order number of your item in the search box and open the item view. Accessories that can be combined with the item are listed in *Accessories*.

13. Inspection and service



WARNING

Loss of the safety function because of damage to the device.

- › In case of damage, the entire device must be replaced.
- › Only accessories or spare parts that can be ordered from EUCHNER may be replaced.

Regular inspection of the following is necessary to ensure trouble-free long-term operation:

- › Check the switching function (see chapter 9.3. *Functional check on page 25*)
- › Check the secure mounting of the devices and the connections
- › Check for contamination

No servicing is required. Repairs to the device are only allowed to be made by the manufacturer.



NOTICE

The year of manufacture can be seen in the lower right corner of the type label. The current version number in the format (VX.X.X) can also be found on the device.

14. Service

If servicing is required, please contact:

EUCHNER GmbH + Co. KG
Kohlhammerstraße 16
70771 Leinfelden-Echterdingen

Service telephone:

+49 711 7597-500

E-mail:

support@euchner.de

Internet:

www.euchner.com

15. Declaration of conformity

The product complies with the requirements according to

- › Machinery Directive 2006/42/EC (until January 19, 2027)
- › Machinery Regulation (EU) 2023/1230 (from January 20, 2027)

The EU declaration of conformity can be found at www.euchner.com. Enter the order number of your device in the search box. The document is available under *Downloads*.

Euchner GmbH + Co. KG
Kohlhammerstraße 16
70771 Leinfelden-Echterdingen
info@euchner.de
www.euchner.com

Edition:
2119563-13-02/25
Title:
Operating Instructions Non-Contact Safety Switch
CES-AR.-C04/C14-...
(translation of the original operating instructions)
Copyright:
© EUCHNER GmbH + Co. KG, 02/2025

Subject to technical modifications; no responsibility is accepted for the accuracy of this information.