

EUCHNER

Operating Instructions

**Transponder-Coded Safety Switch With Guard Locking
CET.-AP-... (Unicode/Multicode)**

EN

Contents

1.	About this document	4
1.1.	Scope.....	4
1.2.	Target group	4
1.3.	Key to symbols.....	4
1.4.	Supplementary documents	4
2.	Correct use	5
3.	Description of the safety function	6
4.	Exclusion of liability and warranty	6
5.	General safety precautions	7
6.	Function	8
6.1.	Guard lock monitoring	8
6.2.	Monitoring output (OUT)	8
6.3.	Door monitoring output (OUT D).....	9
6.4.	Diagnostic output (DIA).....	9
6.5.	Guard locking on version CET3	9
6.6.	Guard locking on version CET4	9
6.7.	Start button and feedback loop (optional)	10
6.8.	Switching states	10
7.	Manual release	11
7.1.	Auxiliary release and auxiliary key release (can be retrofitted)	11
7.1.1.	Actuating auxiliary release	11
7.1.2.	Actuating auxiliary key release	11
7.2.	Emergency release (can be retrofitted)	12
7.2.1.	Actuating emergency release	12
7.3.	Escape release (optional)	12
7.3.1.	Actuating escape release.....	13
7.4.	Wire front release (optional)	13
7.4.1.	Laying wire front release.....	13
8.	Changing the approach direction	13
9.	Mounting	14
10.	Electrical connection	16
10.1.	Notes about 	17
10.2.	Safety in case of faults.....	17
10.3.	Fuse protection for power supply	17
10.4.	Requirements for connecting cables.....	18

10.5.	Connector assignment of safety switch CET-AP for connection to decentralized peripheral systems with plug connectors 2 x M12 (5-pin)	19
10.5.1.	Version without door monitoring output (CET3/4); door position is indicated on LED 1	19
10.5.2.	Version with door monitoring output OUT D; door position is indicated on LED 1	19
10.6.	Connector assignment of safety switch CET-AP with plug connector 1 x M12 (8-pin); door position is indicated on LED 1	19
10.7.	Connector assignment of safety switch CET-AP with plug connector M23 (RC18)	20
10.8.	Connection	21
10.9.	Notes on operation with safe control systems	26
10.10.	Devices for direct connection to IP65 field modules	26
11.	Setup	27
11.1.	LED displays	27
11.2.	Teach-in function for actuator (only for unicode evaluation)	27
11.2.1.	Preparing device for the teach-in operation and teaching in actuator	28
11.3.	Functional check	29
11.3.1.	Mechanical function test	29
11.3.2.	Electrical function test	29
12.	System status table	30
13.	Technical data	31
13.1.	Technical data for safety switch CET.-AP-C.-AH-...	31
13.1.1.	Typical system times	32
13.2.	Dimension drawing for safety switch CET.-AP-...	33
13.3.	Technical data for actuator CET-A-B...	35
13.3.1.	Dimension drawing for actuator CET-A-BWK-50X	35
14.	Ordering information and accessories	36
15.	Inspection and service	36
16.	Service	36
17.	Declaration of conformity	37

1. About this document





1.1. Scope

These operating instructions are valid for all CET.-AP from version V1.5.0 and for CET.-AP with lockout bar from V 1.5.1. These operating instructions, the document *Safety information* and any enclosed data sheet form the complete user information for your device.

1.2. Target group



Design engineers and installation planners for safety devices on machines, as well as setup and servicing staff possessing special expertise in handling safety components.

1.3. Key to symbols

Symbol/depiction	Meaning
	Printed document
	Document is available for download at www.euchner.com
	This section is applicable only if the memory card is used
 DANGER WARNING CAUTION	Safety precautions Danger of death or severe injuries Warning about possible injuries Caution Device damage possible
 NOTICE Important!	Important information
Tip	Useful information

1.4. Supplementary documents

The overall documentation for this device consists of the following documents:

Document title (document number)	Contents	
Safety information (2525460)	Basic safety information	
Operating instructions (2122242)	(this document)	
Possibly enclosed data sheet	Item-specific information about deviations or additions	

	Important! Always read all documents to gain a complete overview of safe installation, setup and use of the device. The documents can be downloaded from www.euchner.com . For this purpose enter the doc. no. in the search box.
---	--

2. Correct use

Safety switches series CET-AP are interlocking devices with guard locking (type 4). The device complies with the requirements according to EN IEC 60947-5-3. Devices with unicode evaluation possess a high coding level, devices with multicode evaluation possess a low coding level.

In combination with a movable guard and the machine control, this safety component prevents the guard from being opened while a dangerous machine function is being performed.

This means:

- Starting commands that cause a dangerous machine function must become active only when the guard is closed and locked.
- The guard locking must not be released until the dangerous machine function has ended.
- Closing and locking a guard must not cause automatic starting of a dangerous machine function. A separate start command must be issued. For exceptions, refer to EN ISO 12100 or relevant C-standards.

Devices from this series are also suitable for process protection.

Before the device is used, a risk assessment must be performed on the machine, e.g. in accordance with the following standards:

- EN ISO 13849-1
- EN ISO 12100
- IEC 62061

Correct use includes observing the relevant requirements for installation and operation, particularly based on the following standards:

- EN ISO 13849-1
- EN ISO 14119
- EN 60204-1

The safety switch is allowed to be operated only in conjunction with the intended EUCHNER actuator and the related connection components from EUCHNER. On the use of different actuators or other connection components, EUCHNER provides no warranty for safe function.



Important!

- The user is responsible for the proper integration of the device into a safe overall system. For this purpose, the overall system must be validated, e.g. in accordance with EN ISO 13849-2.
- It is only allowed to use components that are permissible in accordance with the table below.

Table 1: Possible combinations for CET components

Safety switch	Actuator	
	CET-A-B...	
CET.-AP-... (Unicode/Multicode)	●	
Key to symbols	●	Combination possible

3. Description of the safety function

Devices from this series feature the following safety functions:

Monitoring of guard locking and the position of the guard (interlocking device with guard locking according to EN ISO 14119)

- Safety function (see chapter 6.8. *Switching states on page 10*):
 - The safety outputs are switched off when guard locking is released (monitoring of the locking element).
 - The safety outputs are switched off when the guard is open (monitoring of the door position).
 - Guard locking can be activated only when the actuator is located in the switch head (prevention of inadvertent locking position (faulty closure protection)).
- Safety characteristics: category, Performance Level, PFH_D (see chapter 13. *Technical data on page 31*).

Control of guard locking

If the device is used as guard locking for personnel protection, the control of the guard locking must be regarded as a safety function.

The device does not feature a safety characteristic for the control of the guard locking, because the guard locking solenoid is completely disconnected from outside the device (no control function within the device). It therefore does not contribute to the failure probability.

The safety level for the control of guard locking is determined exclusively by the external control (e.g. PFH_{D_{ext.}} for the standstill monitor).

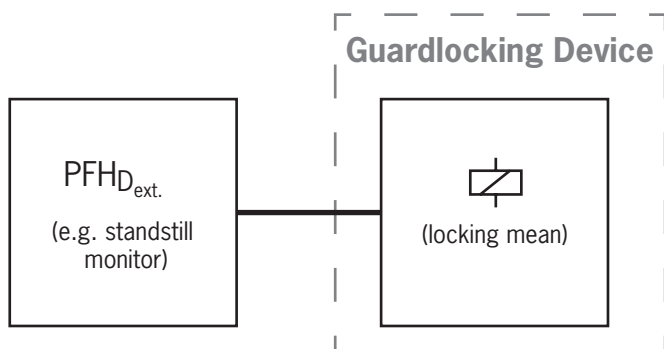

4. Exclusion of liability and warranty

In case of failure to comply with the conditions for correct use stated above, or if the safety regulations are not followed, or if any servicing is not performed as required, liability will be excluded and the warranty void.

5. General safety precautions

Safety switches fulfill personnel protection functions. Incorrect installation or tampering can lead to fatal injuries to personnel.

Check the safe function of the safeguard particularly

- › after any setup work
- › after the replacement of a CET component
- › after an extended period without use
- › after every fault

Independent of these checks, the safe function of the safeguard should be checked at suitable intervals as part of the maintenance schedule.



WARNING

Danger to life due to improper installation or due to bypassing (tampering). Safety components perform a personnel protection function.

- › Safety components must not be bypassed, turned away, removed or otherwise rendered ineffective. On this topic pay attention in particular to the measures for reducing the possibility of bypassing according to EN ISO 14119:2013, section 7.
- › The switching operation must be triggered only by actuators designated for this purpose.
- › Prevent bypassing by means of replacement actuators (only for multicode evaluation). For this purpose, restrict access to actuators and to keys for releases, for example.
- › Mounting, electrical connection and setup only by authorized personnel possessing the following knowledge:
 - specialist knowledge in handling safety components
 - knowledge about the applicable EMC regulations
 - knowledge about the applicable regulations on operational safety and accident prevention.



Important!

Prior to use, read the operating instructions and keep these in a safe place. Ensure the operating instructions are always available during mounting, setup and servicing. For this reason you should archive a printed copy of the operating instructions. You can download the operating instructions from www.euchner.com.

6. Function

The device permits the locking of movable guards.

The system consists of the following components: coded actuator (transponder) and switch.

Whether the device learns the complete actuator code (unicode) or not (multicode) depends on the respective version.

- › **Devices with unicode evaluation:** The actuator must be assigned to the safety switch by a teach-in operation so that it is detected by the system. This unambiguous assignment ensures a particularly high level of protection against tampering. The system thus possesses a high coding level.
- › **Devices with multicode evaluation:** Unlike systems with unique code detection, on multicode devices a specific code is not requested but instead it is only checked whether the actuator is of a type that can be detected by the system (multicode detection). There is no exact comparison of the actuator code with the taught-in code in the safety switch (unique code detection). The system possesses a low coding level.

When the guard is closed, the actuator is moved towards the safety switch. When the operating distance is reached, power is supplied to the actuator by the switch and data are transferred.

The safety outputs  are switched on when the locking pin is in the recess (state: door closed and locked) and a permissible code is detected.

When guard locking is released, the safety outputs  and the monitoring output (OUT) are switched off.

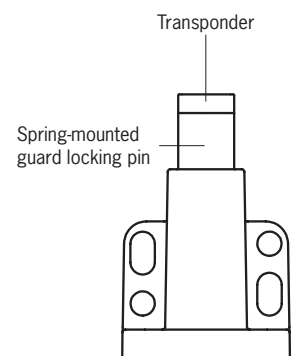
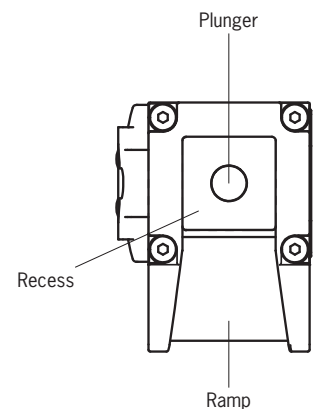
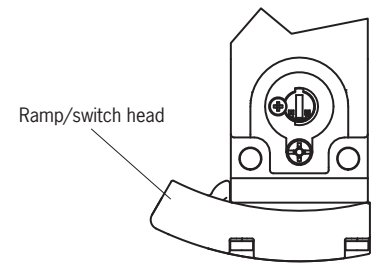

Important!

- › CET3 (closed-circuit current principle)
The activation of the guard locking solenoid results in the shutdown of the safety outputs OA/OB and the monitoring output OUT.
- › CET4 (open-circuit current principle)
The interruption (> 5 ms) of the power supply to U_{CM} results in the shutdown of the safety outputs OA/OB and the monitoring output OUT.
- › In both cases the outputs are shut down independent of the actual position of the solenoid.
- › For more detailed information, see also chapter 10.9. *Notes on operation with safe control systems on page 26.*

In the event of a fault in the safety switch, the safety outputs  are switched off and the DIA LED illuminates red. The occurrence of faults is detected at the latest on the next demand to switch on the safety outputs (e.g. on starting).

6.1. Guard lock monitoring

All versions feature two safe outputs for monitoring guard locking (OA and OB). The safety outputs  are switched off when guard locking is released.

6.2. Monitoring output (OUT)

The monitoring output is switched on as soon as guard locking is active (state: door closed and locked) and the transponder has been recognized.

6.3. Door monitoring output (OUT D)

Versions CET3 and CET4 feature a door monitoring output (OUT D). The door monitoring output is switched on as soon as the actuator is above the extended plunger (state: guard closed and not locked). The door monitoring output also remains switched on when guard locking is active.

6.4. Diagnostic output (DIA)

Some versions have a diagnostic output. The diagnostic output is switched on in the event of a fault (switch-on condition as for DIA LED, see chapter 12. *System status table on page 30*).

6.5. Guard locking on version CET3

(guard locking actuated by spring force and released by power-ON)

Activating guard locking: close guard; no voltage at the solenoid.

Releasing guard locking: apply voltage to the solenoid.

The spring-operated guard locking functions in accordance with the closed-circuit current principle. If the voltage is interrupted at the solenoid, the guard locking remains active and the guard cannot be opened directly.



Important!

If the guard is open when the power supply is interrupted and is then closed, guard locking is activated. This can lead to persons being locked in unintentionally.

The actuator's guard locking pin cannot be moved out of the recess and the guard is locked as long as the plunger is pressed down by the actuator.

When voltage is present at the guard locking solenoid, the plunger is extended and lifts the actuator's guard locking pin above the edge of the recess. The guard can be opened.

6.6. Guard locking on version CET4

(guard locking actuated by power-ON and released by spring force)



Important!

Use as guard locking for personnel protection is possible only in special cases, after strict assessment of the accident risk (see EN ISO 14119:2013, section 5.7.1)!

Activating guard locking: apply voltage to the solenoid.

Releasing guard locking: disconnect voltage from the solenoid.

The magnetically actuated guard locking operates in accordance with the open-circuit current principle. If the voltage is interrupted at the solenoid, the guard locking is released and the guard can be opened directly!

The guard can be opened as long as the plunger is held in the extended position.

The plunger is released when voltage is present at the guard locking solenoid. The actuator's guard locking pin can now press the plunger down. The guard is locked as soon as the guard locking pin is fully inserted into the recess.

6.7. Start button and feedback loop (optional)

A start button and a feedback loop can be connected (for monitoring downstream relays and contactors) (input Y).



Important!



Faults on the start button or in the feedback loop are not detected. This can lead to unintentional automatic starting.

On devices with start button and feedback loop, safety outputs  are switched on only when the start button is pressed and the feedback loop is closed. Start button and feedback loop must be closed for at least 500 ms.

The monitoring output OUT is switched on as soon as guard locking is active. The status of the feedback loop or the start button has no influence on this (see also chapter 12. System status table on page 30).

6.8. Switching states

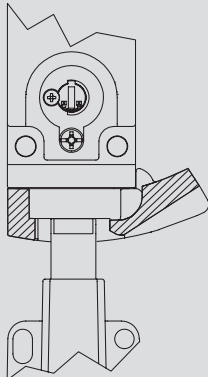
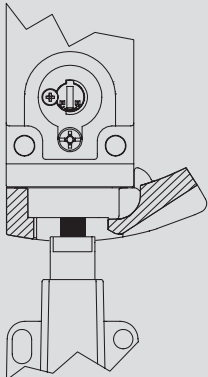
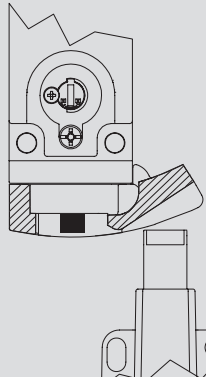
The detailed switching states for your switch can be found in the system status table. All safety outputs, monitoring outputs and LED displays are described there.

	Guard closed and locked	Guard closed and not locked	Guard open
			
Voltage on guard locking solenoid CET3	off	on	(irrelevant)
Voltage on guard locking solenoid CET4	on	off	(irrelevant)
Safety outputs OA and OB 	on	off	off
Monitoring output OUT	on	off	off
Door monitoring output OUT D	on	on	off

7. Manual release

Some situations require the guard locking to be released manually (e.g. malfunctions or an emergency). A function test should be performed after release.

More information on this topic can be found in the standard EN ISO 14119:2013, section 5.7.5.1. The device can feature the following release functions:

7.1. Auxiliary release and auxiliary key release (can be retrofitted)

In the event of malfunctions, the guard locking can be released with the auxiliary release or the auxiliary key release irrespective of the state of the solenoid.

The safety outputs \overline{TP} are switched off when the auxiliary release or the auxiliary key release is actuated. Use the safety outputs \overline{TP} to generate a stop command.

The monitoring output OUT is switched off; OUT D can assume an undefined state. Open the guard and close it again after resetting the auxiliary release or auxiliary key release. The device will then operate normally again.



Important!

- › The actuator must not be under tensile stress during manual release.
- › After use, reset the auxiliary release and screw in and seal the locking screw (e.g. with sealing lacquer).
- › The auxiliary key release must not be used to lock the switch during servicing to prevent activation of guard locking, for example.
- › Loss of the release function due to mounting errors or damage during mounting.
- › Check the release function every time after mounting.
- › Please observe the notes on any enclosed data sheets.

7.1.1. Actuating auxiliary release

1. Unscrew locking screw.
 2. Using a screwdriver, turn the auxiliary release to  in the direction of the arrow.
- ➔ Guard locking is released.

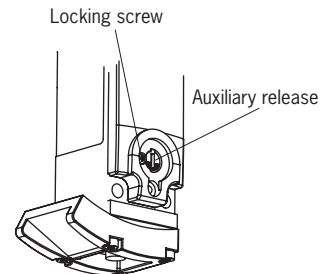

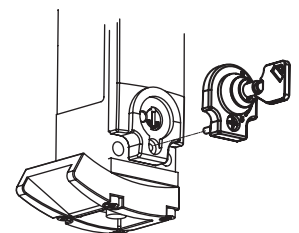

7.1.2. Actuating auxiliary key release

On devices with auxiliary key release (can be retrofitted), simply turn the key to release. Function as for auxiliary release. For mounting, see the auxiliary key release supplement.



7.2. Emergency release (can be retrofitted)

Permits opening of a locked guard from outside the danger zone without tools. For mounting, see the mounting supplement.

The safety outputs  are switched off when the emergency release is actuated. Use the safety outputs  to generate a stop command.

The monitoring output OUT is switched off; OUT D can assume an undefined state. Open the guard and close it again after resetting the emergency release. The device will then operate normally again.



Important!

- › It must be possible to operate the emergency release manually from outside the protected area without tools.
- › The emergency release must possess a marking indicating that it may be used only in an emergency.
- › The actuator must not be under tensile stress during manual release.
- › The emergency release must be sealed or the misuse of the release function must be prevented in the control system.
- › The release function meets all other requirements from EN ISO 14119.
- › The emergency release meets the requirements of Category B according to EN ISO 13849-1:2015.
- › Loss of the release function due to mounting errors or damage during mounting.
- › Check the release function every time after mounting.
- › Please observe the notes on any enclosed data sheets.

7.2.1. Actuating emergency release

Turn emergency release clockwise until it clicks into place.

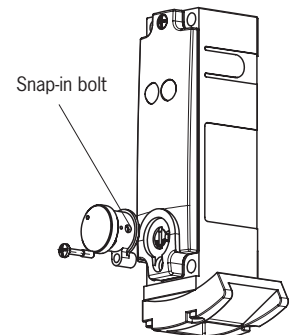

- ➔ Guard locking is released.

To reset, press the snap-in bolt inward using a small screwdriver or similar tool and turn the emergency release back.



7.3. Escape release (optional)

Permits opening of a locked guard from the danger zone without tools (see chapter 13.2. *Dimension drawing for safety switch CET.-AP-... on page 33*).

The safety outputs  are switched off when the escape release is actuated. Use the safety outputs  to generate a stop command.

The monitoring output OUT is switched off; OUT D can assume an undefined state. Open the guard and close it again after resetting the escape release. The device will then operate normally again.



Important!

- › It must be possible to actuate the escape release manually from inside the protected area without tools.
- › It must not be possible to reach the escape release from the outside.
- › The actuator must not be under tensile stress during manual release.
- › The escape release meets the requirements of Category B according to EN ISO 13849-1:2015.

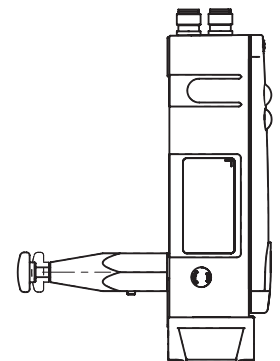

7.3.1. Actuating escape release

Press the red release knob to the stop.

➔ Guard locking is released.

Pull the knob out again to reset.

7.4. Wire front release (optional)

Release via a pull wire. Depending on the type of attachment, the wire front release can be used as an emergency release or escape release.

The following applies to non-latching wire front releases.

If the release is to be used as an emergency release, one of the following measures must be taken (see EN ISO 14119:2013, section 5.7.5.3):

- › Install the release so that it can be reset only with the aid of a tool.
- › Alternatively, resetting can be realized at the control-system level by means of a plausibility check (status of the safety outputs does not match the guard locking control signal), for example.

The emergency-release specifications in chapter 7.2 on Page 12 apply irrespective of this information.

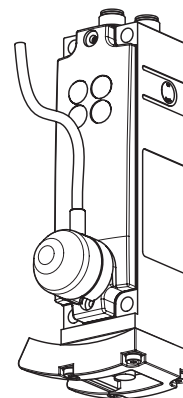

Important!

- › The wire front release meets the requirements of Category B according to EN ISO 13849-1:2015.
- › The correct function depends on the laying of the pull wire and the attachment of the pull handle, and this is the responsibility of the plant manufacturer.
- › The actuator must not be under tensile stress during manual release.

7.4.1. Laying wire front release



Important!

- › Loss of the release function due to mounting errors, damage or wear.
- › Check the release function every time after mounting.
- › When routing the wire front release, ensure that it operates smoothly.
- › Observe the min. bending radius (100 mm) and minimize the number of bends.
- › The switch is not allowed to be opened.
- › Observe the notes on the enclosed data sheets.

8. Changing the approach direction

1. Remove the screws from the safety switch.
2. Set the required direction.
3. Tighten the screws with a torque of 1.5 Nm.

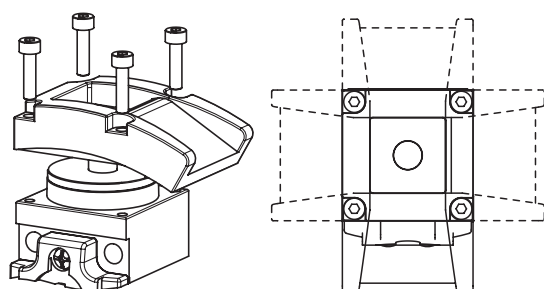

Figure 1: Changing the approach direction

9. Mounting



CAUTION

Safety switches must not be bypassed (bridging of contacts), turned away, removed or otherwise rendered ineffective.

- › Observe EN ISO 14119:2013, section 7, for information about reducing the possibilities for bypassing an interlocking device.



NOTICE

Risk of damage to equipment and malfunctions as a result of incorrect installation.

- › Safety switches and actuators must not be used as an end stop.
- › Observe EN ISO 14119:2013, sections 5.2 and 5.3, for information about mounting the safety switch and the actuator.
- › Protect the switch head against damage, as well as penetrating foreign objects such as swarf, sand and blasting shot, etc. The switch should be installed with the actuating head down for this purpose.
- › Observe the min. door radii (see *Figure 2*).
- › Ensure that the actuator contacts the ramp in the designated area (see figure below). Marks on the ramp specify the prescribed approach zone.



Tip!

EUCHNER offers special cover plates to improve protection against tampering. These accessories can be found at www.euchner.com.

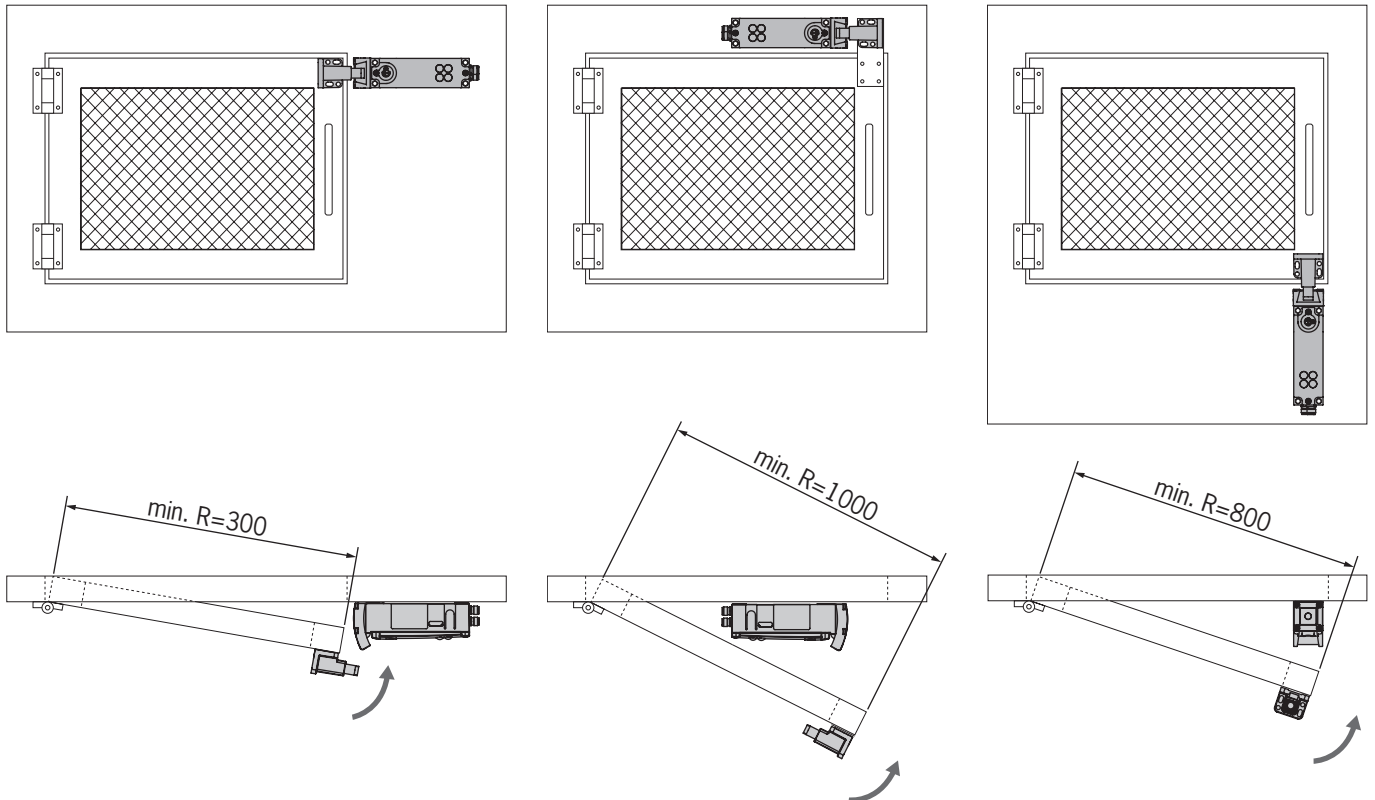
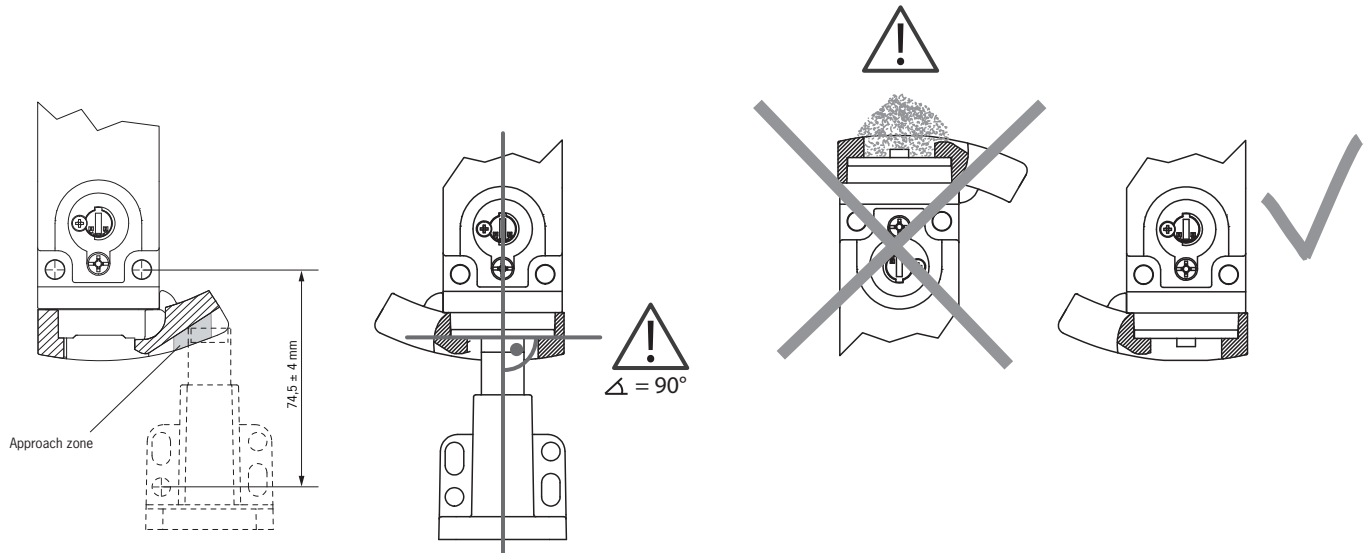

Figure 2: Installation situation and door radii

Note the following points:

Actuator and safety switch must be fitted so that

- › the active faces of the actuator and the safety switch are parallel with each other.
- › the actuator is fully inserted into the switch recess when the guard is closed.
- › no dirt can accumulate in the recess.



10. Electrical connection



WARNING

- In the event of a fault, loss of the safety function due to incorrect connection.
- › To ensure safety, both safety outputs  (OA and OB) must always be evaluated.
 - › Monitoring outputs must not be used as safety outputs.
 - › Lay the connecting cables with protection to prevent the risk of short circuits.



CAUTION

- Risk of damage to equipment or malfunctions as a result of incorrect connection.
- › The power supply for the evaluation electronics is electrically isolated from the power supply for the guard locking solenoid.
 - › The teach-in input and feedback loop are at ground potential 0 V U_B.
 - › The device generates its own test pulses on the output lines OA/OB. A downstream control system must tolerate these test pulses, which may have a length of up to 0.3 ms. The test pulses are output only if the safety outputs are switched on. Depending on the inertia of the downstream device (control system, relay, etc.), this can lead to short switching processes.
 - › The inputs on an evaluation unit connected must be positive-switching, as the two outputs on the safety switch deliver a level of +24 V in the switched-on state.
 - › The device is suitable for operation on earth-leakage monitors.
 - › All the electrical connections must either be isolated from the mains supply by a safety transformer according to IEC 61558-2-6 with limited output voltage in the event of a fault, or by other equivalent isolation measures (PELV).
 - › All electrical outputs must have an adequate protective circuit for inductive loads. The outputs must be protected with a free-wheeling diode for this purpose. RC interference suppression units must not be used.
 - › Power devices which are a powerful source of interference must be installed in a separate location away from the input and output circuits for signal processing. The cable routing for safety circuits should be as far away as possible from the cables of the power circuits.
 - › To avoid EMC interference, the physical environmental and operating conditions at the installation site of the device must comply with the requirements according to the standard EN 60204-1:2006, section 4.4.2 (EMC). Pay attention to any interference fields from devices such as frequency converters or induction heating systems. Observe the EMC instructions in the manuals from the respective manufacturer.





Important!

If the device does not appear to function when operating voltage is applied (e.g. green STATE LED does not flash), the safety switch must be returned unopened to the manufacturer.

10.1. Notes about



Important!

- › This device is intended to be used with a *Class 2* power source in accordance with UL1310. As an alternative an LV/C (Limited Voltage/Current) power source with the following properties can be used:
 - This device shall be used with a suitable isolating source in conjunction with a fuse in accordance with UL248. The fuse shall be rated max. 3.3 A and be installed in the max. 30 V DC power supply to the device in order to limit the available current to comply with the  requirements. Please note possibly lower connection ratings for your device (refer to the technical data).
- › For use and applications as per the  requirements ¹⁾, a connecting cable listed under UL category code CYJV/7 must be used.

1) Note on the scope of the UL approval: the devices have been tested as per the requirements of UL508 and CSA/ C22.2 no. 14 (protection against electric shock and fire).

10.2. Safety in case of faults

- › The operating voltage U_B and the solenoid voltage U_{CM} are reverse polarity protected.
- › The safety outputs OA/OB are short circuit-proof.
- › A short circuit between OA and OB is detected by the switch.
- › A short circuit in the cable can be excluded by laying the cable with protection.

10.3. Fuse protection for power supply

The power supply must be provided with fuse protection depending on the number of switches and current required for the outputs. The following rules apply:

Max. current consumption I_{max}

$$I_{max} = I_{UB} + I_{OUT} + I_{OA+OB} (+ I_{OUT D}^*)$$

$$I_{UB} = \text{Switch operating current (80 mA)}$$

$$I_{OUT} / I_{OUT D} = \text{Load current of monitoring outputs (2 x max. 50 mA)}$$

$$I_{OA+OB} = \text{Load current of safety outputs OA + OB (2 x max. 200 mA)}$$

* only for version with door monitoring output

10.4. Requirements for connecting cables



CAUTION

Risk of damage to equipment or malfunctions as a result of incorrect connecting cables.

- › Use connection components and connecting cables from EUCHNER.
- › On the use of other connection components, the requirements in the following table apply. EUCHNER provides no warranty for safe function in case of failure to comply with these requirements.

Observe the following requirements with respect to the connecting cables:

For safety switch CET-AP with plug connector M12

Parameter	Value	Unit
Conductor cross-section, min.	0.25	mm ²
R max.	60	Ω/km
C max.	120	nF/km
L max.	0.65	mH/km
Recommended cable type	LIYY 8 x 0.25 mm ²	

For safety switch CET-AP with plug connector M23 (RC18)

Parameter	Value	Unit
Conductor cross-section, min.	0.25	mm ²
R max.	60	Ω/km
C max.	120	nF/km
L max.	0.65	mH/km
Recommended cable type	LIFY11Y min. 19-core	

10.5. Connector assignment of safety switch CET-AP for connection to decentralized peripheral systems with plug connectors 2 x M12 (5-pin)

10.5.1. Version without door monitoring output (CET3/4); door position is indicated on LED 1

Wiring diagram A

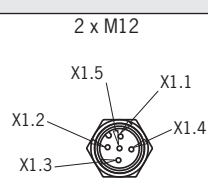
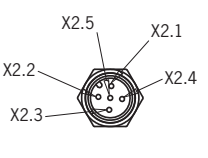
Plug connector (view of connection side)	Pin	Designation	Function	Conductor coloring of connecting cable 1)
	X 1.1	U_B	Operating voltage, 24 V DC	BN
	X 1.2	OA	Safety output channel A	WH
	X 1.3	0 V U_B	Operating voltage, 0 V	BU
	X 1.4	OB	Safety output channel B	BK
	X 1.5	-		n.c.
	X 2.1	-	n.c.	BN
	X 2.2	-	n.c.	WH
	X 2.3	0 V U_{CM}	OV solenoid	BU
	X 2.4	U_{CM}	Operating voltage of guard locking solenoid, 24 V DC	BK
	X 2.5	-		n.c.

1) Only for standard EUCHNER connecting cable.

10.5.2. Version with door monitoring output OUT D; door position is indicated on LED 1

Wiring diagram B

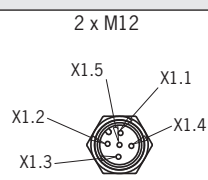
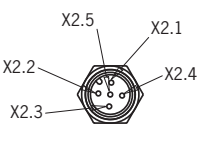
Plug connector (view of connection side)	Pin	Designation	Function	Conductor coloring of connecting cable 1)
	X 1.1	U_B	Operating voltage, 24 V DC	BN
	X 1.2	OA	Safety output channel A	WH
	X 1.3	0 V U_B	Operating voltage, 0 V	BU
	X 1.4	OB	Safety output channel B	BK
	X 1.5	-		n.c.
	X 2.1	-	n.c.	BN
	X 2.2	OUT D	Door monitoring output	WH
	X 2.3	0 V U_{CM}	OV solenoid	BU
	X 2.4	U_{CM}	Operating voltage of guard locking solenoid, 24 V DC	BK
	X 2.5	-		n.c.

1) Only for standard EUCHNER connecting cable.

10.6. Connector assignment of safety switch CET-AP with plug connector 1 x M12 (8-pin); door position is indicated on LED 1.

Wiring diagram C/D

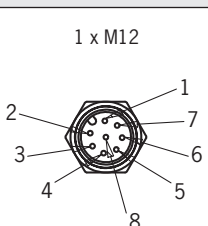
Plug connector (view of connection side)	Pin	Designation	Function	Conductor coloring of connecting cable 1)
	1	U_{CM}	Operating voltage of guard locking solenoid, 24 V DC	WH
	2	U_B	Operating voltage, 24 V DC	BN
	3	OA	Safety output channel A	GN
	4	OB	Safety output channel B	YE
	5	OUT DIA	Monitoring output	GY
	6	OUT D	Door monitoring output	PK
	7	0 V U_B	Operating voltage, 0 V	BU
	8	0 V U_{CM}	OV solenoid	RD

1) Only for standard EUCHNER connecting cable.

10.7. Connector assignment of safety switch CET-AP with plug connector M23 (RC18)

Wiring diagram E

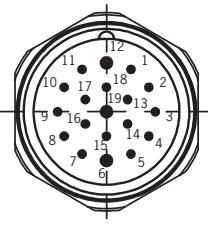
Plug connector (view of connection side)	Pin	Designation	Function	Conductor coloring of connecting cable ¹⁾
	1	U_{CM}	Operating voltage of guard locking solenoid, 24 V DC	VT
	2	-	n.c.	-
	3	-	n.c.	-
	4	OA	Safety output channel A	RDBU
	5	OB	Safety output channel B	GN
	6	U_B	Operating voltage, 24 V DC	BU
	7	RST	Reset	GYRD
	8	OUT D	Door monitoring output	WHGN
	9	-	n.c.	-
	10	OUT	Monitoring output	WHGY
	11	-	n.c.	-
	12	FE	Function earth This connection must be connected to 0 V.	YEGN
	13	J	Teach-in input To teach-in a new actuator, connect to 24 V DC; leave open in normal operation. ²⁾	PK
	14	-	n.c. Do not connect to 0 V!	-
	15	-	n.c.	BNGN
	16	-	n.c.	YEBN
	17	-	n.c.	-
	18	0 V U_{CM}	0V solenoid	YE
	19	0 V U_B	Operating voltage, 0 V	BN

1) Only for standard EUCHNER connecting cable.

2) With dual-channel solenoid control, do not connect to 0 V U_{CM} .

10.8. Connection

Connect the device as shown in the figures below. The monitoring outputs can be routed to a control system.

The switches can be reset via the RST input. To do this, a voltage of 24 V is applied to the RST input for at least 3 s.



WARNING

In the event of a fault, loss of the safety function due to incorrect connection.

› To ensure safety, both safety outputs  (OA and OB) must always be evaluated.



Important!

› The example shows only an excerpt that is relevant for connection of the CET system. The example illustrated here does not show complete system planning. The user is responsible for safe integration into the overall system. Detailed application examples can be found at www.euchner.com. Simply enter the order number of your switch in the search box. All available connection examples for the device can be found in "Downloads."

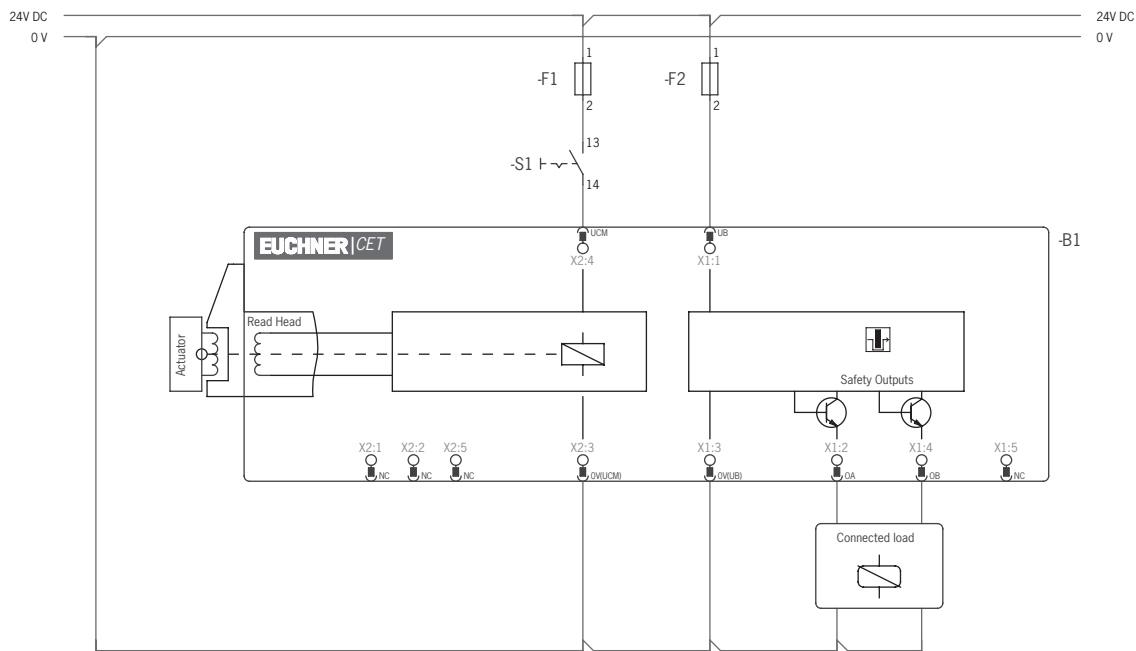

Figure 3: Wiring diagram A, CET 3/4-AP with plug connector 2 x M12, without door monitoring output
Single-channel control of the guard locking solenoid

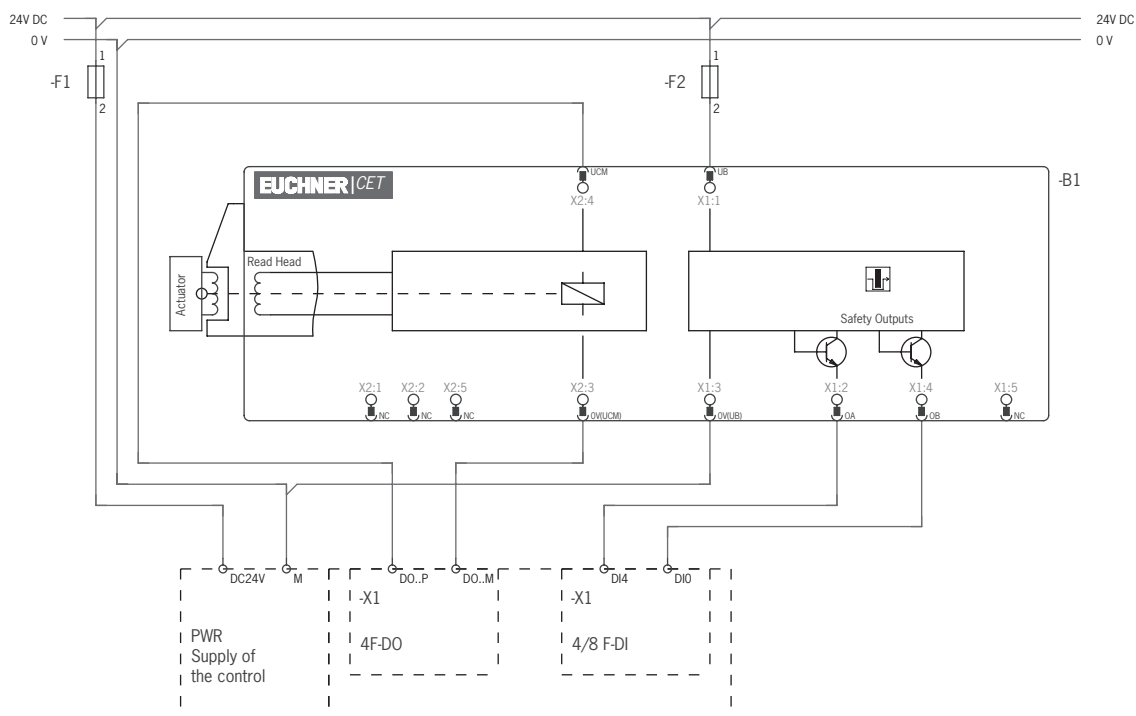

Figure 4: Wiring diagram A, CET 3/4-AP with plug connector 2 x M12, without door monitoring output
Dual-channel control of the guard locking solenoid

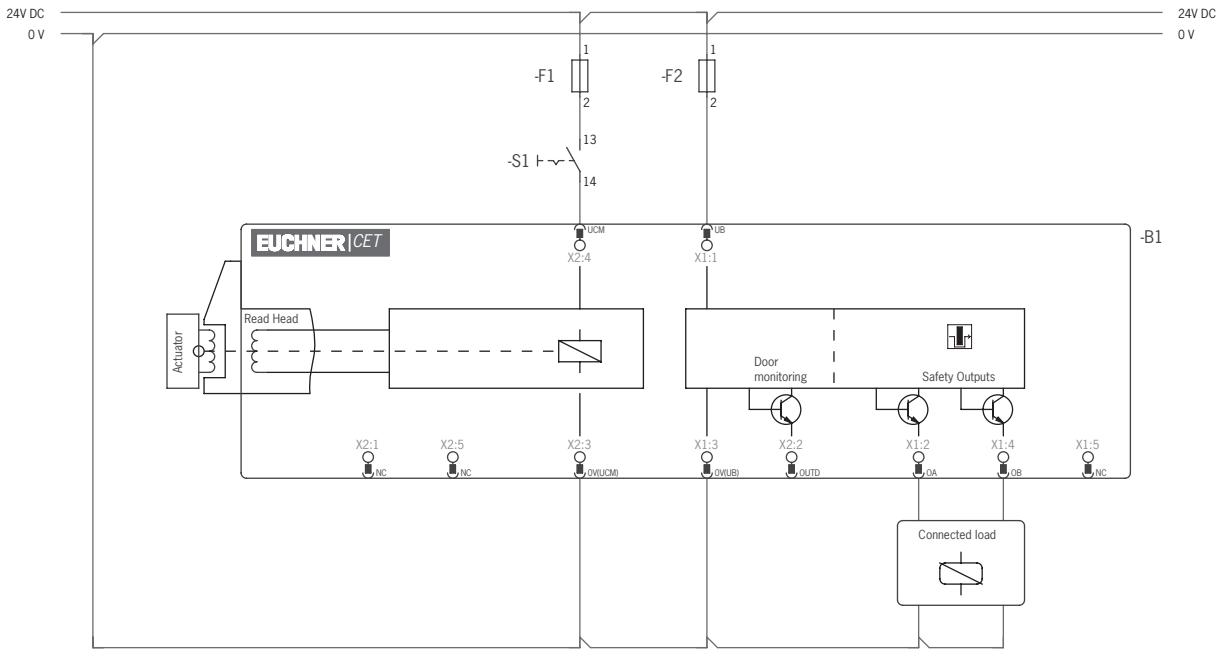

Figure 5: Wiring diagram B, CET 3/4-AP with plug connector 2 x M12, with door monitoring output
Single-channel control of the guard locking solenoid

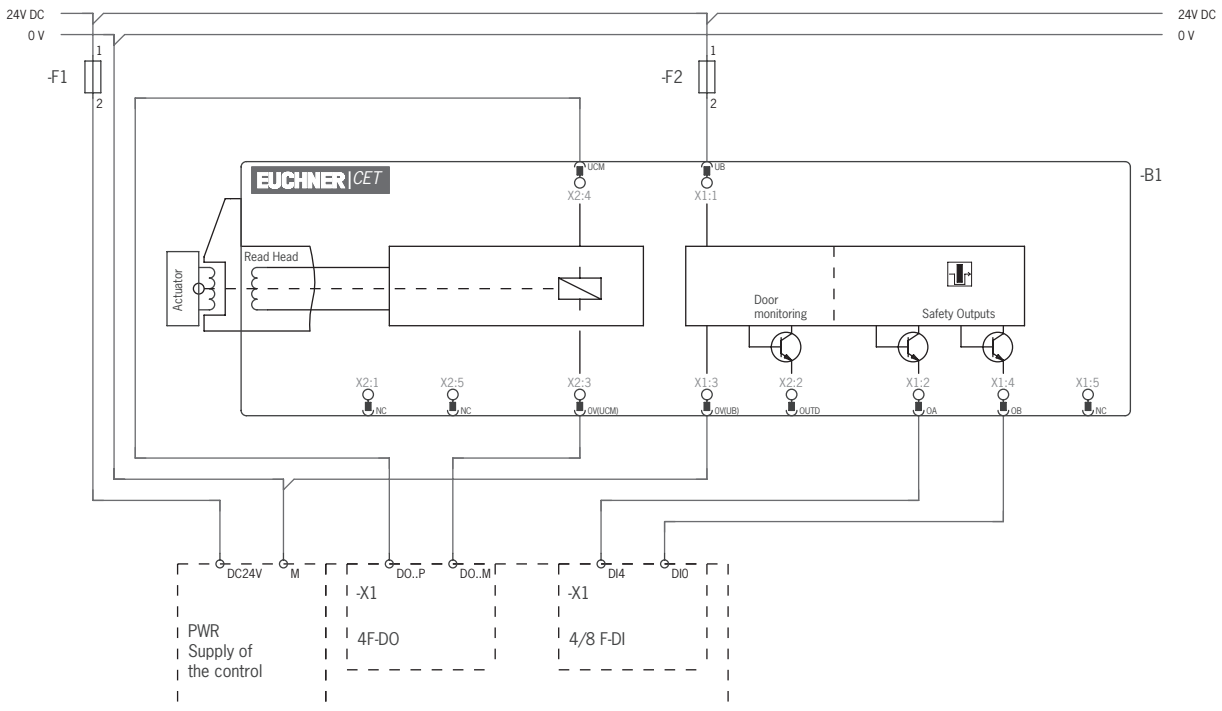

Figure 6: Wiring diagram B, CET 3/4-AP with plug connector 2 x M12, with door monitoring output
Dual-channel control of the guard locking solenoid

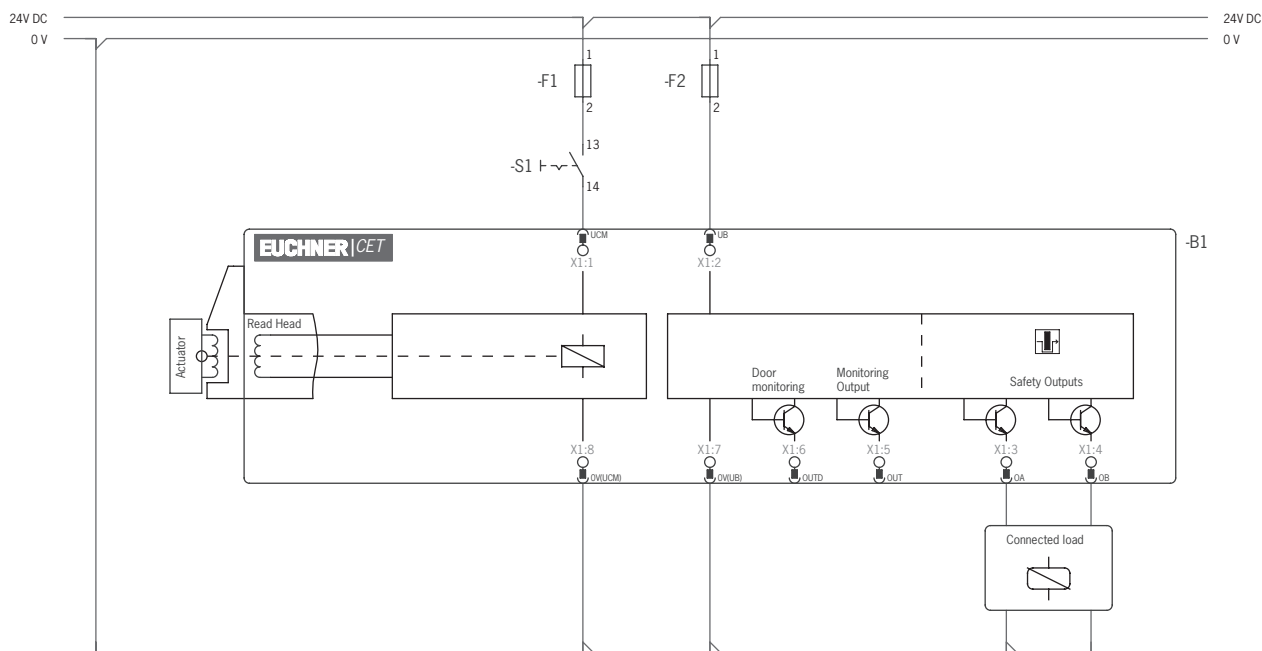

Figure 7: Wiring diagram C/D, CET 3/4-AP with plug connector 1 x M12, with monitoring output OUT or DIA on X1:5
Single-channel control of the guard locking solenoid

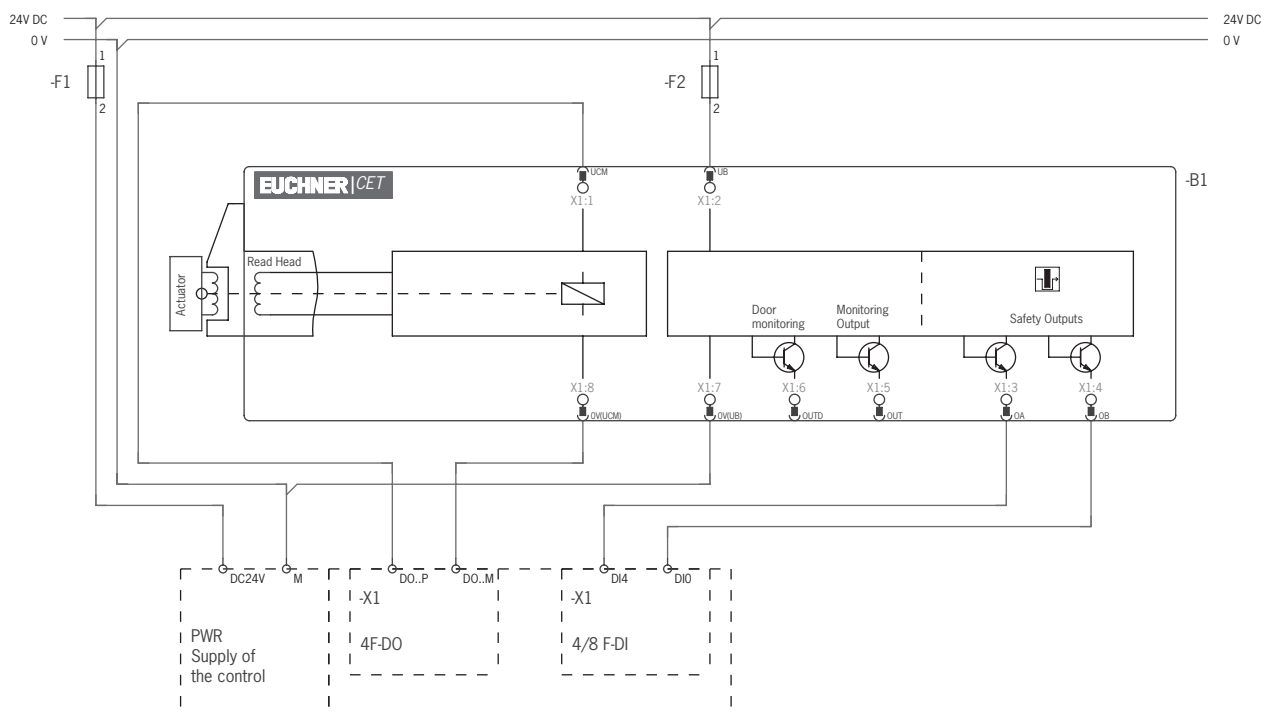

Figure 8: Wiring diagram C/D, CET 3/4-AP with plug connector 1 x M12, with monitoring output OUT or DIA on X1:5
Dual-channel control of the guard locking solenoid

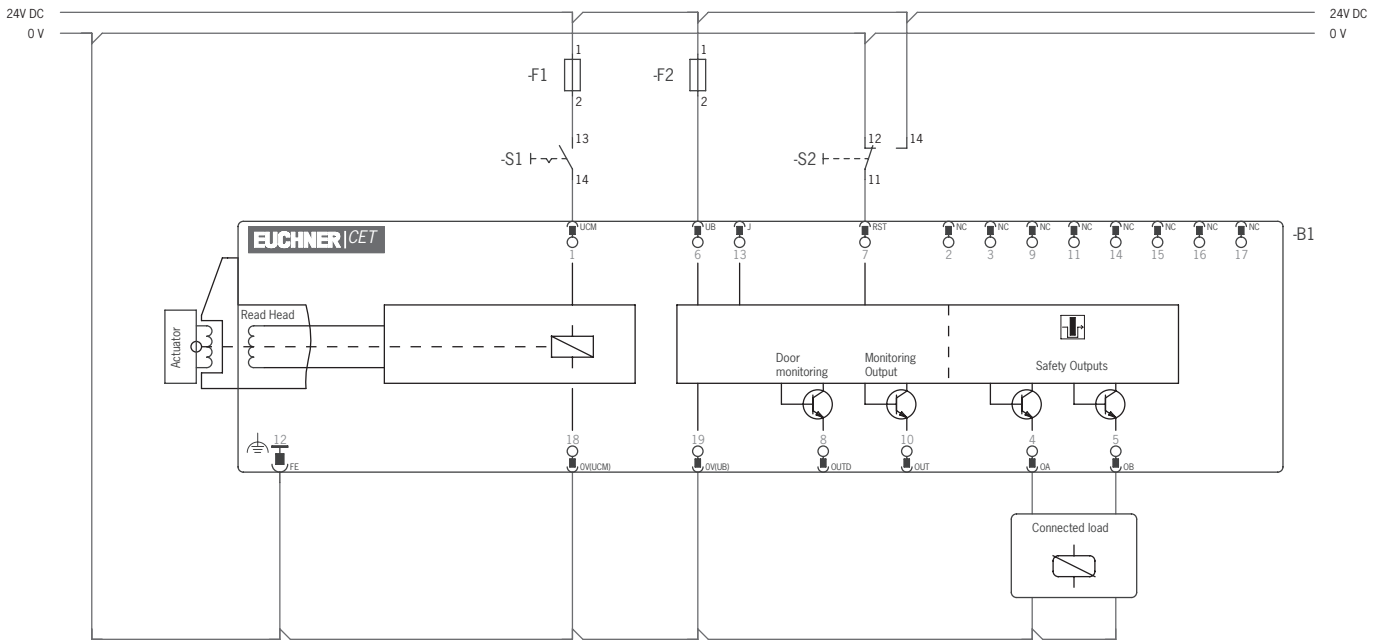

Figure 9: Wiring diagram E, CET 3/4-AP with plug connector 1 x M23
Single-channel control of the guard locking solenoid

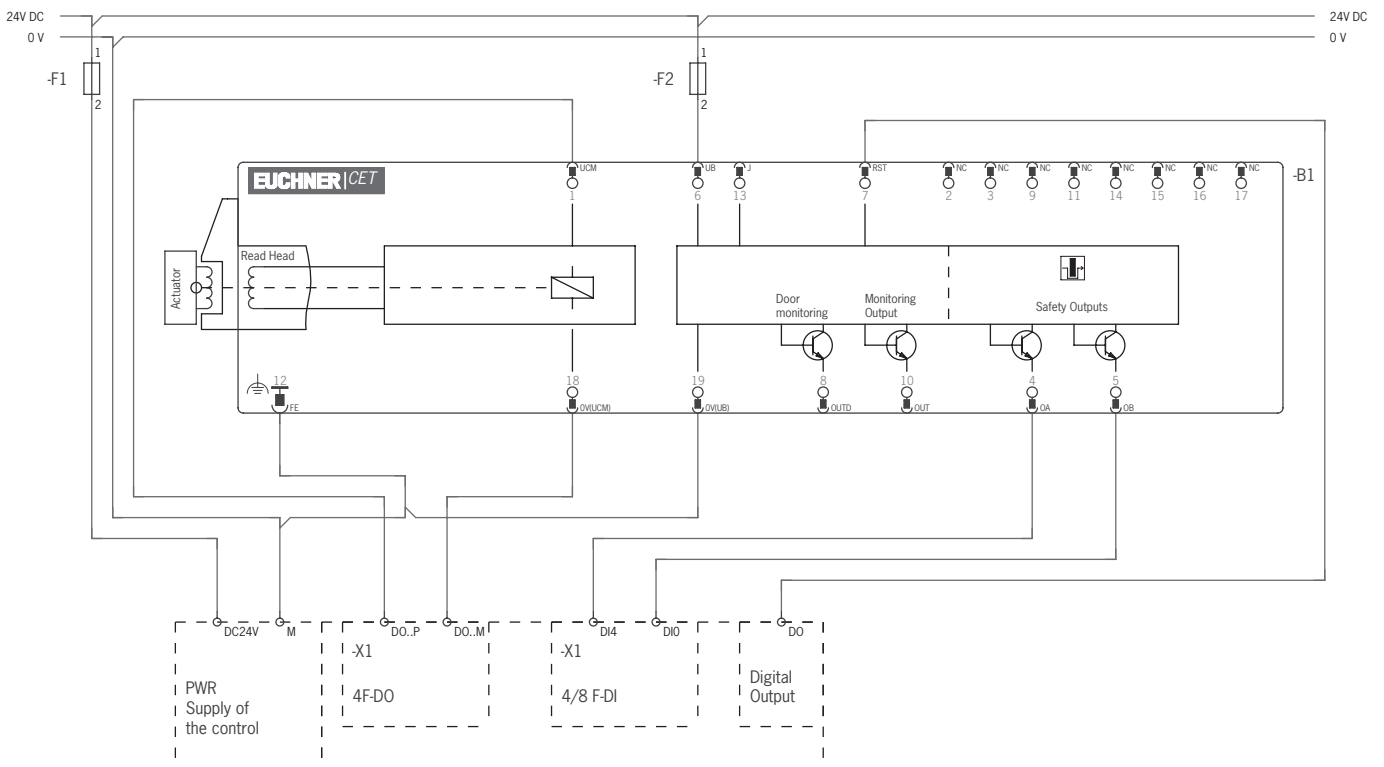



Figure 10: Wiring diagram E, CET 3/4-AP with plug connector 1 x M23
Dual-channel control of the guard locking solenoid

10.9. Notes on operation with safe control systems

Please observe the following requirements for connection to safe control systems:

- › Use a common power supply for the control system and the connected safety switches.
- › The device tolerates interruptions in the operating voltage at U_B and ground interruptions at $0\text{ V } U_B$ of up to 5 ms. If the power supply is connected to a terminal of a safe control system, this output must provide sufficient electrical current.
- › The following applies to dual-channel control of the guard locking solenoid:
 - CET 3/4-AP from version V1.5.2: The device tolerances shut-off pulses up to 5 ms.
 - CET 3/4-AP from V1.7.0: The device tolerates switch-on and shut-off pulses up to 5 ms.
- › The safety outputs  (OA and OB) can be connected to the safe inputs of a control system. Prerequisite: The input must be suitable for pulsed safety signals (OSSD signals, e.g. from light grids). The control system must tolerate test pulses on the input signals. This normally can be set up by parameter assignment in the control system. Observe the notes of the control system manufacturer. For the test-pulse duration of your safety switch, please refer to chapter 13.1. *Technical data for safety switch CET.-AP-C.-AH... on page 31.*

A detailed example of connecting and setting the parameters of the control system is available for many devices at www.euchner.com, in the area *Downloads/Applications/CET*. The features of the respective device are dealt with there in greater detail.

10.10. Devices for direct connection to IP65 field modules

The version CET.-AP-...-SI... (wiring diagram A) is optimized for connection to decentralized peripheral systems, such as the ET200pro series from Siemens. The devices are parameterized and connected like an OSSD (e.g. like light curtains).

The two 5-pin M12 plug connectors can be connected directly to the sockets of an IP65 field module (e.g. ET200pro). If flying leads are used, connection to IP20 input and output modules (e.g. ET200s) is naturally also possible.

On versions CET.-AP-...-SI... (wiring diagram B) with door monitoring output OUT D, it is necessary to use the Y-distributor AC-YD-V0,2-SBB-124516 for direct connection to decentralized peripheral systems such as the ET200pro series from Siemens. More information about the wiring diagram is available at www.euchner.com, under the respective devices.



Important!

Observe the following notes prior to connection:

- › Use only CET-AP versions that are intended to be used for this purpose.
- › Parameter assignment must be performed for the input/output modules (see application example at www.euchner.com, in the area *Downloads/Applications/CET*).
- › Additionally observe notes from the control system manufacturer where necessary.

11. Setup

11.1. LED displays

You will find a detailed description of the signal functions in chapter 12. *System status table on page 30.*

LED	Color
STATE	green
DIA	red
LED 1	red
LED 2	green

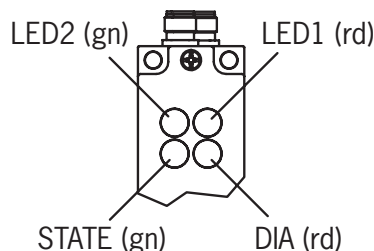

NOTICE

- ▶ With hard-wired LEDs the following applies:
 - LED 1:red = Solenoid activated (voltage present at solenoid)
 - LED 2:green = OUT D is switched on (door is closed)
- ▶ Depending on version, the function of LED 1 and LED 2 can differ. Detailed information is available on the enclosed data sheet or at www.euchner.com. Simply enter the order number of your device in the search box.

11.2. Teach-in function for actuator (only for unicode evaluation)

The actuator must be allocated to the safety switch using a teach-in function before the system forms a functional unit.

During a teach-in operation, the safety outputs and the monitoring output OUT are switched off, i.e. the system is in the safe state.

Depending on the version, the teach-in operation is automatic or is performed with the aid of the teach-in input J.



Tip!

We recommend performing the teach-in operation prior to mounting. Mark switches and actuators that belong together in order to avoid confusion.



Important!

- ▶ The teach-in operation may be performed only if the device functions flawlessly. The red DIA LED must not be illuminated.
- ▶ The safety switch disables the code of the preceding device if teach-in is carried out for a new actuator. Teach-in is not possible again immediately for this device if a new teach-in operation is carried out. The disabled code is released again in the safety switch only after a third code has been taught-in.
- ▶ The safety switch can be operated only with the last actuator taught-in.
- ▶ Version without teach-in input: After starting, the device remains in teach-in standby state for 3 min. If no new actuator is detected in this time, the device changes to normal operation. If the switch detects the actuator that was most recently taught-in when in the teach-in standby state, this state is ended immediately and the switch changes to normal operation.
- ▶ Version with teach-in input: Teach-in operation ends when the power supply to the teach-in input is interrupted, but no later than after 3 min. If no actuator is detected during this time, the device enters the fault state. If the switch detects the actuator that was most recently taught-in when in the teach-in standby state, this state is ended immediately and the switch changes to the fault state.
- ▶ The actuator to be taught-in is not activated if it is within the actuating range for less than 60 s.

11.2.1. Preparing device for the teach-in operation and teaching in actuator

1. Connect the switch as shown below, but do not apply any voltage to U_B yet.

For version with teach-in input: For the teach-in standby state, the teach-in input J must be connected to +24 V DC.

For devices without teach-in input: The circuit is the same, but connection J is omitted.

Observe different control of guard locking for CET3 and CET4.

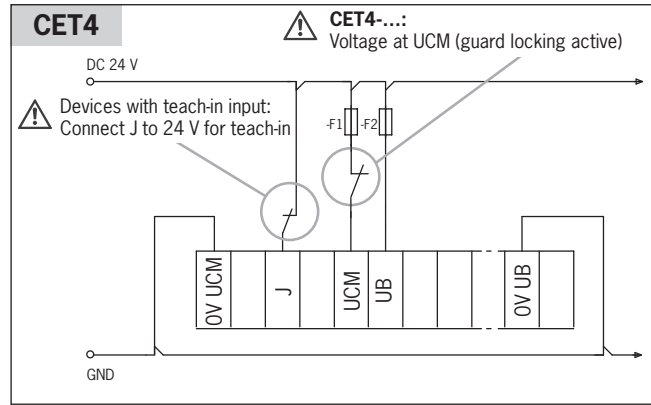
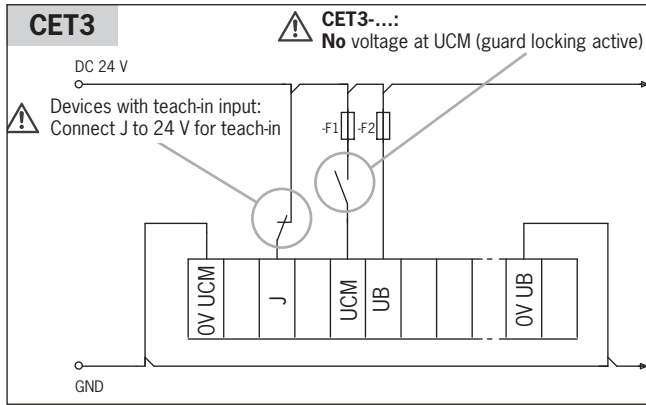

2. Switch on operating voltage U_B .

➔ A self-test is performed for approx. 1 s. After this, the green STATE LED flashes cyclically three times and signals that it is in standby state for teach-in. Standby state for teach-in remains active for approx. 3 min.

➔ If the red DIA LED is illuminated, there is a fault. Teach-in is not possible. The green STATE LED indicates the error code. For diagnostics see section 12. *System status table on page 30.*

3. Activate guard locking.

CET3: no voltage at U_{CM} .

CET4: voltage at U_{CM} .

4. Fully insert new actuator into the recess. Do not cant it; place it in the center of the recess (see picture on right).

➔ Teach-in operation starts, green STATE LED flashes (approx. 1 Hz). The teach-in operation is completed after approx. 60 s, and the green STATE LED goes out.

5. Disconnect operating voltage U_B or apply a voltage of 24 V to RST for at least 3 s.

➔ The code of the actuator that was just taught-in is activated in the safety switch.

6. For version with teach-in input: Disconnect the teach-in input from +24 V and leave open.

7. Switch on operating voltage U_B .

➔ The device operates normally.

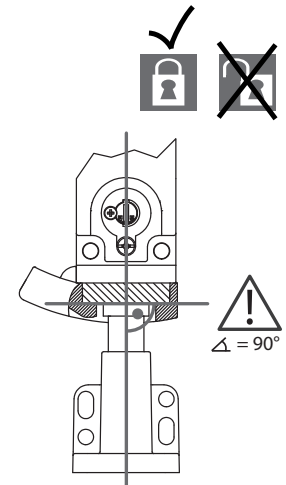

11.3. Functional check



WARNING

Danger of fatal injury as a result of faults in installation and functional check.

- › Before carrying out the functional check, make sure that there are no persons in the danger zone.
- › Observe the valid accident prevention regulations.

11.3.1. Mechanical function test

The actuator must slide easily into the recess on the actuating head. Close the guard several times to check the function. For devices with mechanical release (emergency release or escape release), the correct function of the release must be checked as well.

11.3.2. Electrical function test

After installation and any fault, the safety function must be fully checked. Proceed as follows:

1. Switch on operating voltage.
 - ➔ The machine must not start automatically.
 - ➔ The safety switch carries out a self-test. The green STATE LED then flashes at regular intervals.
2. Close all guards. In case of guard locking by solenoid force: activate guard locking.
 - ➔ The machine must not start automatically. It must not be possible to open the guard.
 - ➔ The green STATE LED illuminates continuously.
3. Enable operation in the control system.
 - ➔ It must not be possible to deactivate guard locking as long as operation is enabled.
4. Disable operation in the control system and deactivate guard locking.
 - ➔ The guard must remain locked until there is no longer any risk of injury.
 - ➔ It must not be possible to start the machine as long as the guard locking is deactivated.

Repeat steps 2 - 4 for each guard.

12. System status table

Operating mode	Actuator/door position	Safety outputs OA and OB 	Monitoring output OUT	Door monitoring output OUT D (only CET3 and CET4)	LED indicator Output		State
					STATE (green)	DIA (red)	
Normal operation	closed	on	on	on		○	Normal operation, door closed and locked
	closed	off	on	on	1 x in-verse	○	Normal operation, door closed and locked, safety outputs not switched because: - Feedback loop not closed (if fitted)
	closed	off	off	on	1 x	○	Normal operation, door closed and not locked
	open	off	off	off	1 x	○	Normal operation, door open
Teach-in operation (only unicode)	open	off	off	off	3 x	○	Door open; device is ready for teach-in for a new actuator (only short time after power-up)
	closed	off	off	off	1 Hz	○	Teach-in operation
	X	off	off	off	○	1	Acknowledgment after successful teach-in operation (DIA flashes once, no repetition)
Fault display	X	off	off	X	2 x		Fault on the power supply (e.g. shut-off pulse duration for pulsed power supply too long)
	X	off	off	off	1 x		Fault in the teach-in operation (only unicode) (e.g. actuator removed from the actuating range prior to the end of the teach-in operation or disabled actuator in the actuating range)
	X	off	off	off	3 x		Actuator faulty
	X	off	off	off	4 x		Output fault (e.g. short circuit, loss of switching ability)
	X	off	off	off	5 x		Internal error, e.g.: - Component faulty - Data error - Impermissible pulsing on U _B - Voltage applied to input RST for less than 3 s
	X	off	off	off	X	X	Internal error
Key to symbols	○						LED not illuminated
							LED illuminated
	10 Hz (10 s)						LED flashes for 10 s at 10 Hz
	3 x						LED cyclically flashes three times
	X						Any state

After the cause has been remedied, faults can generally be reset by opening and closing the guard. If the fault is still displayed afterward, use the reset function or briefly interrupt the power supply. Please contact the manufacturer if the fault could not be reset after restarting.



Important!

If you do not find the displayed device status in the system status table, this indicates an internal device fault. In this case, you should contact the manufacturer.

13. Technical data



NOTICE

If a data sheet is included with the product, the information on the data sheet applies.

13.1. Technical data for safety switch CET.-AP-C..-AH-...

Parameter	Value			Unit
	min.	typ.	max.	
General				
Material, ramp	Stainless steel			
Material, safety switch housing	Die-cast aluminum			
Installation orientation	Any (recommendation: switch head downward)			
Degree of protection	IP67			
with plug connector M12	IP65/IP67			
with plug connector M23 (RC18)				
Safety class	III			
Degree of contamination	3			
Mechanical life	1 x 10 ⁶ operating cycles			
Ambient temperature at U _B	-20	-	+55	°C
Actuator approach speed, max.	20			m/min
Locking force F _{max}	6,500			N
Locking force F _{Zh} in acc. with test principles GS-ET-19	F _{Zh} = F _{max} /1.3 = 5,000			N
Weight	Approx. 1.0			kg
Degrees of freedom (actuator in recess) X, Y, Z	X and Y: ± 5; Z: ± 4			mm
Connection (depending on version)	2 plug connectors M12, 5-pin, 1 plug connector M12, 8-pin, 1 plug connector M23 (RC18), 19-pin			
Operating voltage U _B (reverse polarity protected, regulated, residual ripple < 5%) ¹⁾	24 ± 15% (PELV)			V DC
Current consumption I _B	80			mA
External fuse (operating voltage U _B)	0.25	-	8	A
External fuse (solenoid operating voltage U _{CM})	0.5	-	8	A
Rated insulation voltage U _i	-	-	75	V
Conditional short-circuit current	100			A
Resilience to vibration	Acc. to EN 60947-5-2			
EMC protection requirements	Acc. to EN IEC 60947-5-3			
Ready delay	-	-	1	s
Risk time	-	-	400	ms
Turn-on time	-	-	400	ms
Discrepancy time	-	-	10	ms
Test-pulse duration	-	-	0.3 ²⁾	ms
Safety outputs OA/OB Semiconductor outputs (p-switching, short circuit-proof)				
- Output voltage U _{OA} /U _{OB} ³⁾				
HIGH U _{OA} /U _{OB}	U _B - 1.5	-	U _B	V DC
LOW U _{OA} /U _{OB}	0	-	1	
Switching current per safety output	1	-	200	mA
Utilization category acc. to EN 60947-5-2	DC-13 24 V 200 mA Caution: outputs must be protected with a free-wheeling diode in case of inductive loads			
Switching frequency	0.5			Hz
Monitoring outputs OUT and OUT D (optional) (p-switching, short circuit-proof)				
Output voltage	0.8 x U _B	-	U _B	V DC
Max. load	-	-	50	mA
Teach-in input J or feedback loop input Y				
HIGH	15	-	26.4	V
LOW	0	-	1	
Solenoid				
Solenoid operating voltage U _{CM} (reverse polarity protected, regulated, residual ripple < 5%) ¹⁾	DC 24 V +10%/-15%			
Solenoid current consumption I _{CM}	-	450	-	mA
Power consumption	-	11	-	W
Duty cycle	100			%
Reliability values acc. to EN ISO 13849-1				
Mission time	20			years
Monitoring of guard locking and the guard position Any installation orientation (head downward, upward or horizontal)				
Category	4			
Performance Level (PL)	e			
PFFH _D	3.1 x 10 ⁻⁹ / h			
Control of guard locking				
Category				
Performance Level (PL)	Depends on external control			
PFFH _D				

1) The device tolerates voltage interruptions of up to 5 ms.

2) Applies to a load with C < 30 nF and R < 20 kohm

3) Values at a switching current of 50 mA without taking into account the cable lengths.

13.1.1. Typical system times

Please refer to the technical data for the exact values.

Ready delay: After switch-on, the device carries out a self-test. The system is ready for operation only after this time.

Turn-on time of safety outputs: The max. reaction time t_{on} is the time from the moment when the guard is locked to the moment when the safety outputs switch on.

Risk time according to EN 60947-5-3: If an actuator moves outside the actuating range, the safety outputs \square_{\uparrow} (OA and OB) are deactivated at the latest after the risk time.

Discrepancy time: The safety outputs \square_{\uparrow} (OA and OB) switch with a slight time offset. They have the same signal state no later than after the discrepancy time.

Test pulses at the safety outputs: The device generates its own test pulses on the safety outputs \square_{\uparrow} (OA and OB). A downstream control system must tolerate these test pulses.

This can usually be set up in the control systems by parameter assignment. If parameter assignment is not possible for your control system or if shorter test pulses are required, please contact our support organization.

The test pulses are output only if the safety outputs are switched on.

13.2. Dimension drawing for safety switch CET.-AP-...

Version with plug connectors 2 x M12

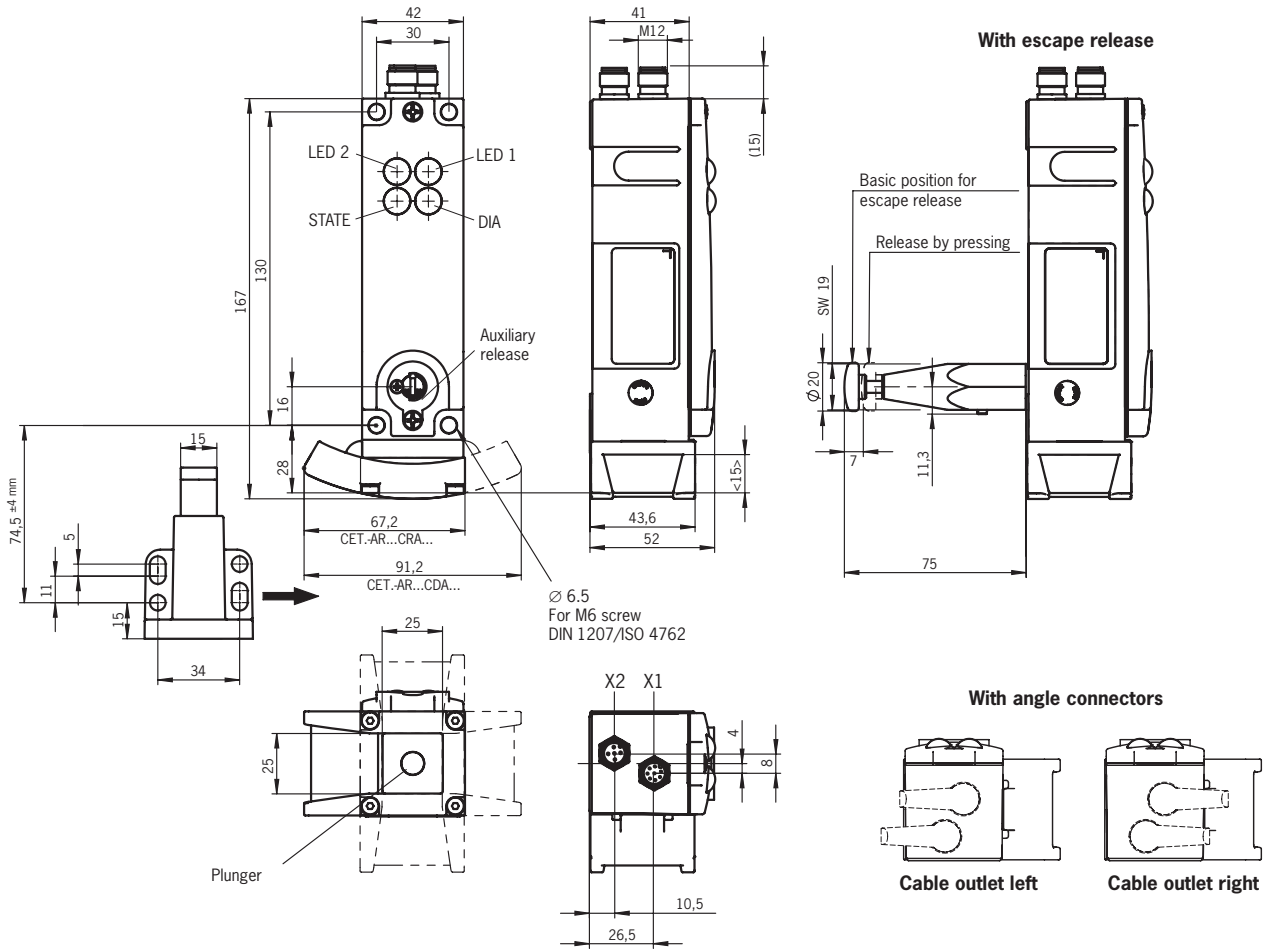

Version with plug connectors 1 x M12

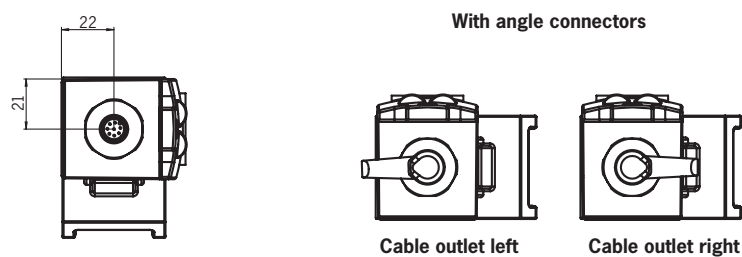

Version with plug connector M23 (RC18)

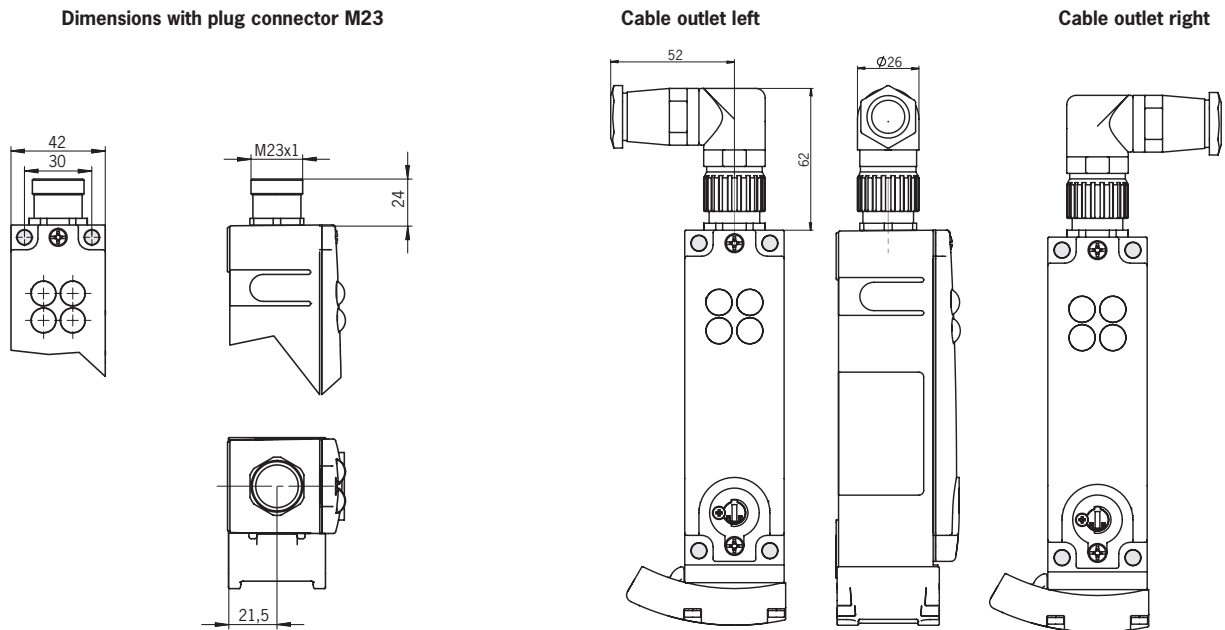

Versions with additional release options

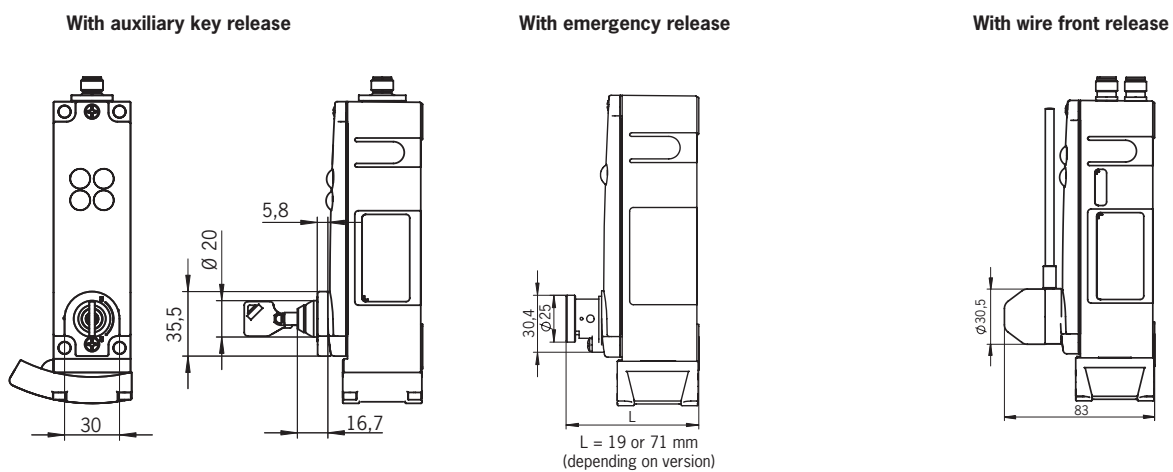

13.3. Technical data for actuator CET-A-B...

Parameter	Value			Unit
	min.	typ.	max.	
Housing material	Stainless steel			
Stroke, max.	15			mm
Weight	0.25			kg
Ambient temperature	- 20	-	+ 55	°C
Degree of protection	IP67 (transponder protection)			
Mechanical life	1 x 10 ⁶ operating cycles			
Locking force, max.	6,500			N
Installation orientation	Active face opposite switch head			
Power supply	Inductive via switch			

13.3.1. Dimension drawing for actuator CET-A-BWK-50X

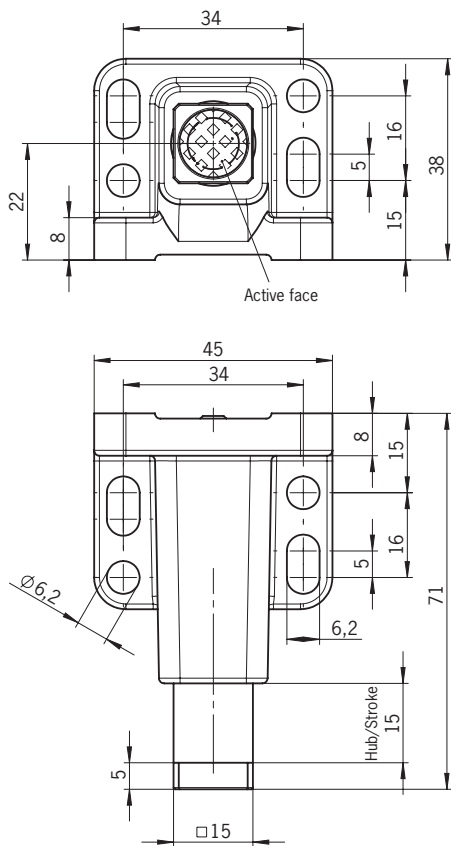

NOTICE

- › Four safety screws M5 x16 are included with the actuator.
- › All four safety screws must always be used.

14. Ordering information and accessories



Tip!

Suitable accessories, e.g. cables or assembly material, can be found at www.euchner.com. To order, enter the order number of your item in the search box and open the item view. Accessories that can be combined with the item are listed in "Accessories."

15. Inspection and service



WARNING

Loss of the safety function because of damage to the device.

- › In case of damage, the entire device must be replaced.
- › Only accessories or spare parts that can be ordered from EUCHNER may be replaced.

Regular inspection of the following is necessary to ensure trouble-free long-term operation:

- › Check the switching function (see chapter 11.3. *Functional check on page 29*)
- › Check all additional functions (e.g. escape release, lockout bar, etc.)
- › Check the secure mounting of the devices and the connections
- › Check for soiling

No servicing is required. Repairs to the device are only allowed to be made by the manufacturer.



NOTICE

The year of manufacture can be seen in the lower right corner of the rating plate. The current version number in the format (V X.X.X) can also be found on the device.

16. Service

If servicing is required, please contact:

EUCHNER GmbH + Co. KG
Kohlhammerstraße 16
70771 Leinfelden-Echterdingen

Service telephone:

+49 711 7597-500

E-mail:

support@euchner.de

Internet:

www.euchner.com

17. Declaration of conformity



EUCHNER

More than safety.

EU-Konformitätserklärung
EU declaration of conformity
Déclaration UE de conformité
Dichiarazione di conformità UE
Declaración UE de conformidad

Original DE
Translation EN
Traduction FR
Traduzione IT
Traducción ES

2110802-11-01/20

Die nachfolgend aufgeführten Produkte sind konform mit den Anforderungen der folgenden Richtlinien (falls zutreffend):
The beneath listed products are in conformity with the requirements of the following directives (if applicable):
Les produits mentionnés ci-dessous sont conformes aux exigences imposées par les directives suivantes (si valable)
I prodotti sotto elencati sono conformi alle direttive sotto riportate (dove applicabili):
Los productos listados a continuación son conforme a los requisitos de las siguientes directivas (si fueran aplicables):

I:	Maschinenrichtlinie Machinery directive Directive Machines Direttiva Macchine Directiva de máquinas	2006/42/EG 2006/42/EC 2006/42/CE 2006/42/CE 2006/42/CE
II:	Funkanlagen-Richtlinie (RED) Radio equipment directive Directive équipement radioélectrique Direttiva apparecchiatura radio Directiva equipo radioeléctrico	2014/53/EU 2014/53/EU 2014/53/UE 2014/53/UE 2014/53/UE
III:	RoHS Richtlinie RoHS directive Directive de RoHS Direttiva RoHS Directiva RoHS	2011/65/EU 2011/65/EU 2011/65/UE 2011/65/UE 2011/65/UE

Die Schutzziele der Niederspannungsrichtlinie 2014/35/EU und EMV Richtlinie 2014/30/EU werden gemäß Artikel 3.1 der Funkanlagen-Richtlinie eingehalten.
The safety objectives of the Low-voltage directive 2014/35/EU and EMC Directive 2014/30/EU comply with article 3.1 of the Radio equipment directive.
Les objectifs de sécurité de la Directive basse tension 2014/35/UE et Directive de CEM 2014/30/UE sont conformes à l'article 3.1 de la Directive équipement radioélectrique.
Gli obiettivi di sicurezza della Direttiva bassa tensione 2014/35/UE e Direttiva CEM 2014/30/UE sono conformi a quanto riportato nell'articolo 3.1 della Direttiva apparecchiatura radio.
Los objetivos de seguridad de la Directiva de bajo voltaje 2014/35/UE y Directiva CEM 2014/30/UE cumplen con el artículo 3.1 de la Directiva equipo radioeléctrico.

Folgende Normen sind angewandt: a: EN 60947-5-3:2013
Following standards are used: b: EN ISO 14119:2013
Les normes suivantes sont appliquées: c: EN ISO 13849-1:2015
Vengono applicate le seguenti norme: d: EN 62026-2:2013 (ASI)
Se utilizan los siguientes estándares: e: EN 50581:2012 (RoHS)
f: EN 50364:2018
g: EN 300 330 V2.1.1

Bezeichnung der Sicherheitsbauteile Description of safety components Description des composants sécurité Descrizione dei componenti di sicurezza Descripción de componentes de seguridad	Type Type Type Tipo Tipo	Richtlinie Directives Directive Direttiva Directivas	Normen Standards Normes Norme Estándares	Zertifikats-Nr. No. of certificate Número du certificat Numero del certificato Número del certificado
Sicherheitsschalter Safety Switches Interrupteurs de sécurité Fincorsa di sicurezza Interruptores de seguridad	CET1-AR... CET2-AR... CET3-AP... CET3-AR... CET4-AP... CET4-AR... CET3-AS... CET4-AS...	I, II, III I, II, III	a, b, c, e, f, g a, b, c, d, e, f, g	UQS 117149 UQS 122248
Betätiger Actuator Actionneur Azionatore Actuador	CET-A-BW...	I, II, III	a, b, c, e, f, g	UQS 122248

Genehmigung der umfassenden Qualitätssicherung (UQS) durch die benannte Stelle 0035
Approval of the full quality assurance system by the notified body 0035
Approbation du système d'assurance qualité complet par l'organisme notifié 0035
Approvazione del sistema di garanzia di qualità totale da parte dell'organismo notificato 0035
Aprobación del sistema de aseguramiento de calidad total por parte del organismo 0035 notificado

TÜV Rheinland Industrie Service GmbH
Alboinstr. 56
12103 Berlin
Germany



EUCHNER

More than safety.

Die alleinige Verantwortung für die Ausstellung dieser Konformitätserklärung trägt der Hersteller:
This declaration of conformity is issued under the sole responsibility of the manufacturer:
La présente déclaration de conformité est établie sous la seule responsabilité du fabricant:
La presente dichiarazione di conformità è rilasciata sotto la responsabilità esclusiva del fabbricante:
La presente declaración de conformidad se expide bajo la exclusiva responsabilidad del fabricante:

EUCHNER GmbH + Co. KG
Kohlhammerstraße 16
70771 Leinfelden-Echterdingen
Germany

i.A. Dipl.-Ing. Richard Holz
Leiter Elektronik-Entwicklung
Manager Electronic Development
Responsable Développement Électronique
Direttore Sviluppo Elettronica
Director de desarrollo electrónico

i.A. Dipl.-Ing.(FH) Duc Binh Nguyen
Dokumentationsbevollmächtigter
Documentation manager
Responsable documentation
Responsabilità della documentazione
Agente documenta

Leinfelden, Januar 2020

EUCHNER GmbH + Co. KG
Kohlhammerstraße 16
70771 Leinfelden-Echterdingen
Germany

Euchner GmbH + Co. KG
Kohlhammerstraße 16
70771 Leinfelden-Echterdingen
info@euchner.de
www.euchner.com

Edition:
2122242-05-03/20
Title:
Operating Instructions Transponder-Coded Safety Switch
CET-AP-...
(Translation of the original operating instructions)
Copyright:
© EUCHNER GmbH + Co. KG, 03/2020

Subject to technical modifications; no responsibility is accepted for the accuracy of this information.

Third-party trademark information:
SIMATIC ET200pro and ET200S are trademarks of SIEMENS AG.