

EUCHNER

Operating Instructions

**Transponder-Coded Safety Switch without Guard Locking
CTP-I-BP Unicode/Multicode V1.3.X**

EN

Contents

1.	About this document	4
1.1.	Scope.....	4
1.2.	Target group	4
1.3.	Key to symbols.....	4
1.4.	Supplementary documents	4
2.	Correct use	5
3.	Description of the safety function	6
4.	Exclusion of liability and warranty	6
5.	General safety precautions	6
6.	Function	7
6.1.	Monitoring outputs/status bits	7
6.1.1.	Door position signal OD.....	7
6.1.2.	Diagnostic signal OI	7
6.1.3.	Status signal OM.....	7
6.1.4.	Communication connection C.....	7
6.2.	Version CTP Extended.....	7
6.3.	Switching states	8
7.	Changing the approach direction	8
8.	Mounting	9
9.	Electrical connection	10
9.1.	Notes about c  us.....	11
9.2.	Safety in case of faults.....	11
9.3.	Fuse protection for power supply	11
9.4.	Requirements for connecting cables.....	12
9.5.	Connector assignment of safety switch CTP-...-BP-...-SA-... with plug connector M12, 8-pin.....	12
9.6.	Connection.....	13
9.7.	Notes on operation with safe control systems.....	14
10.	Using communication data	15
10.1.	Connection to a BR/IO-Link Gateway GWY-CB.....	15
10.2.	Connection to a safety relay ESM-CB.....	15
10.3.	Overview of the communication data	15
10.3.1.	Cyclical data (process data).....	15
10.3.2.	Acyclical data (device data and events).....	16

11.	Setup	17
11.1.	LED displays	17
11.2.	Teaching-in actuator (only for unicode evaluation)	17
11.3.	Functional check.....	18
11.3.1.	Mechanical function test.....	18
11.3.2.	Electrical function test.....	18
11.4.	Factory reset.....	18
12.	System status table CTP-I-BP	19
13.	Technical data	20
13.1.	Technical data for safety switch CTP-I-BP	20
13.2.	Typical system times.....	21
13.3.	Radio frequency approvals.....	22
13.4.	Dimension drawing for safety switch CTP.....	23
13.5.	Technical data for actuator CTP-... ..	24
13.5.1.	Dimension drawing for actuator CTP-... ..	24
14.	Ordering information and accessories	27
15.	Inspection and service	27
16.	Service	27
17.	Declaration of conformity	27

1. About this document





1.1. Scope

These operating instructions apply to all CTP-I-BP of version V1.3.X. These operating instructions, the document *Safety information* and any available data sheet form the complete user information for your device.

1.2. Target group







Design engineers and installation planners for safety devices on machines as well as setup and servicing staff possessing special expertise in handling safety components.

1.3. Key to symbols

Symbol/depiction	Meaning
	Printed document
	Document is available for download at www.euchner.com
 DANGER WARNING CAUTION	Safety precautions Danger of death or severe injuries Warning about possible injuries Caution slight injuries possible
 NOTICE Important!	Notice about possible device damage Important information
Tip	Useful information

1.4. Supplementary documents

The overall documentation for this device consists of the following documents:

Document title (document number)	Contents	
Safety information (2525460)	Basic safety information	
Operating instructions (MAN20001422)	(this document)	
Declaration of conformity	Declaration of conformity	
Possibly available data sheet	Item-specific information about deviations or additions	 
	Important! Always read all documents to gain a complete overview of safe installation, setup and use of the device. The documents can be downloaded from www.euchner.com . For this purpose enter the doc. no. in the search box.	

2. Correct use

Safety switches series CTP-I-BP... are interlocking devices without guard locking solenoid (type 4). The device meets the requirements according to EN IEC 60947-5-3. Devices with unicode evaluation possess a high coding level, devices with multicode evaluation possess a low coding level.

In combination with a movable guard and the machine control, this safety component prevents dangerous machine functions from occurring while the guard is open. A stop command is triggered if the guard is opened during the dangerous machine function.

This means:

- › Starting commands that cause a dangerous machine function must become active only when the guard is closed.
- › Opening the guard triggers a stop command.
- › Closing a guard must not cause automatic starting of a dangerous machine function. A separate start command must be issued. For exceptions, refer to EN ISO 12100 or relevant C-standards.

Before the device is used, a risk assessment must be performed on the machine, e.g. in accordance with the following standards:

- › EN ISO 13849-1
- › EN ISO 12100
- › IEC 62061

Correct use includes observing the relevant requirements for installation and operation, particularly based on the following standards:

- › EN ISO 13849-1
- › EN ISO 14119
- › EN 60204-1

The safety switch is allowed to be operated only in conjunction with the intended EUCHNER actuator and the related connection components from EUCHNER. On the use of different actuators or other connection components, EUCHNER provides no warranty for safe function.



Important!

- › The user is responsible for the proper integration of the device into a safe overall system. For this purpose, the overall system must be validated, e.g. in accordance with EN ISO 13849-2.
- › It is only allowed to use components that are permissible in accordance with the table below.

Table 1: Possible combinations for CTP components

Safety switch	Actuator	
	A-C-H-...	
CTP-I-BP Unicode/Multicode	●	
Key to symbols	●	Combination possible

3. Description of the safety function

Devices from this series feature the following safety functions:

Monitoring of the guard position (interlocking device according to EN ISO 14119)

- › Safety function (see chapter 6.3. *Switching states on page 8*):
 - The safety outputs are switched off when the guard is open (monitoring of the door position).
- › Safety characteristics: category, Performance Level, PFH_D (see chapter 13. *Technical data on page 20*).

4. Exclusion of liability and warranty

In case of failure to comply with the conditions for correct use stated above, or if the safety regulations are not followed, or if any servicing is not performed as required, liability will be excluded and the warranty void.

5. General safety precautions

Safety switches fulfill personnel protection functions. Incorrect installation or tampering can lead to fatal injuries to personnel.

Check the safe function of the safeguard particularly

- › after any setup work
- › after the replacement of a system component
- › after an extended period without use
- › after every fault

Independent of these checks, the safe function of the safeguard should be checked at suitable intervals as part of the maintenance schedule.



WARNING

Danger to life due to improper installation or due to bypassing (tampering). Safety components fulfill a personnel protection function.

- › Safety components must not be bypassed, turned away, removed or otherwise rendered ineffective. On this topic pay attention in particular to the measures for reducing the possibility of bypassing according to EN ISO 14119:2013, section 7.
- › The switching operation must be triggered only by actuators designated for this purpose.
- › Prevent bypassing by means of replacement actuators (only for multicode evaluation). For this purpose, restrict access to actuators and to keys for releases, for example.
- › Mounting, electrical connection and setup only by authorized personnel possessing the following knowledge:
 - specialist knowledge in handling safety components
 - knowledge about the applicable EMC regulations
 - knowledge about the applicable regulations on operational safety and accident prevention



Important!

Prior to use, read the operating instructions and keep these in a safe place. Ensure the operating instructions are always available during mounting, setup and servicing. For this reason you should archive a printed copy of the operating instructions. You can download the operating instructions from www.euchner.com.

6. Function

The device monitors the position of movable guards.

The system consists of the following components: coded actuator (transponder) and switch.

Whether the device learns the complete actuator code (unicode) or not (multicode) depends on the respective version.

- **Devices with unicode evaluation:** The actuator must be assigned to the safety switch by a teach-in operation so that it is detected by the system. This unambiguous assignment ensures a particularly high level of protection against tampering. The system thus possesses a high coding level.
- **Devices with multicode evaluation:** Unlike systems with unicode evaluation, on multicode devices a specific code is not requested but instead it is only checked whether the actuator is of a type that can be detected by the system (multicode evaluation). There is no exact comparison of the actuator code with the taught-in code in the safety switch (unicode evaluation). The system possesses a low coding level.

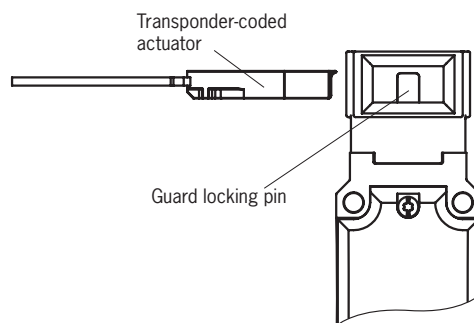

When the guard is closed, the actuator is moved into the safety switch. When the operating distances are reached, power is supplied to the actuator by the switch and data are transferred.

If a permissible code is detected, the safety outputs are switched on.

The safety outputs are switched off and the door position signal OD is cleared when the guard is opened.

In the event of a fault in the safety switch, the safety outputs are switched off and the DIA LED illuminates red. The occurrence of faults is detected at the latest on the next demand to close the safety outputs (e.g. on starting).

6.1. Monitoring outputs/status bits

Depending on version, the signals listed in the following are available as a status bit or at the monitoring output. The status bits are evaluated via the BR/IO-Link Gateway. Please refer to the corresponding data sheet for further information.

6.1.1. Door position signal OD

The door position signal is sent as soon as the actuator is inserted into the switch head (state: guard closed).

6.1.2. Diagnostic signal OI

The diagnostic signal is present if there is an error (switch-on condition as for DIA LED).

6.1.3. Status signal OM

The status signal is present if the device's safety outputs are switched.

6.1.4. Communication connection C

A monitoring output with the suffix C has the additional function of providing a communication connection to a BR/IO-Link Gateway. The switch delivers cyclical and acyclical data. You will find an overview of the communication data in chapter 10. *Using communication data on page 15.*

If no BR/IO-Link Gateway is connected, this output behaves like a monitoring output.

6.2. Version CTP Extended

Devices in the Extended version contain additional controls/indicators in the housing cover. Please refer to the corresponding data sheet for further information.

6.3. Switching states

The detailed switching states for your switch can be found in the system status table (see chapter 12. System status table CTP-I-BP on page 19). All safety outputs, signals and display LEDs are described there.

	Guard closed	Guard open
Safety outputs FO1A and FO1B 	on	off
Door position signal OD	on	off

7. Changing the approach direction

The approach direction needs to be changed only if the switch is to be approached from the rear.

Proceed as follows:

1. Remove the screws from the safety switch.
2. Set the required direction.
3. Tighten the screws with a torque of 1.2 Nm.

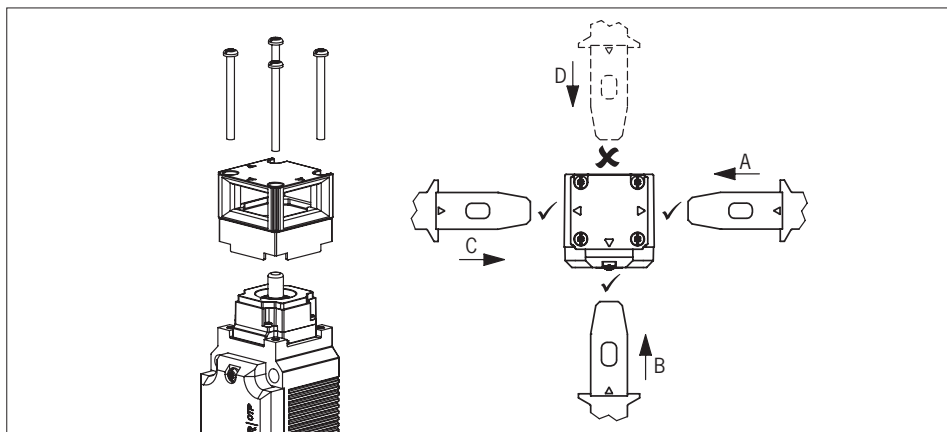

Fig. 1: Changing the approach direction

8. Mounting



CAUTION

Safety switches must not be bypassed (bridging of contacts), turned away, removed or otherwise rendered ineffective.

- › Observe EN ISO 14119:2013, section 7, for information about reducing the possibilities for bypassing an interlocking device.



CAUTION

Risk of damage to equipment and malfunctions as a result of incorrect installation.

- › Safety switches and actuators must not be used as an end stop.
- › Observe EN ISO 14119:2014, sections 5.2 and 5.3, for information about mounting the safety switch and the actuator. The following specifications must be observed:
 - Mounting with screws of property class 8.8 or higher.
 - The minimum screw diameter for CTP devices is 4 mm.
 - Secure the fixing material against loosening (e.g. by means of medium-strength positive screw locking).
- › Protect the switch head against damage, as well as penetrating foreign objects such as swarf, sand and blasting shot, etc.
- › Observe the min. door radii (see chapter 13.5.1. *Dimension drawing for actuator CTP-... on page 24*).
- › Observe the tightening torque for mounting the switch: max.1.4 Nm



CAUTION

Device damage or malfunctions caused by material changes due to the environment.

- › Contact the manufacturer if you have any questions about environmental influences or about use in aggressive environments.



Important!

- › From the assured release distance S_{ar} , the safety outputs are safely shut down. To achieve the assured release distance S_{ar} the actuator must be pulled completely out of the switch head.
- › To achieve the assured operating distance S_{ao} the actuator must be inserted completely into the switch head.

A clearance of 12 mm must be maintained around the actuator head (see Fig. 2).

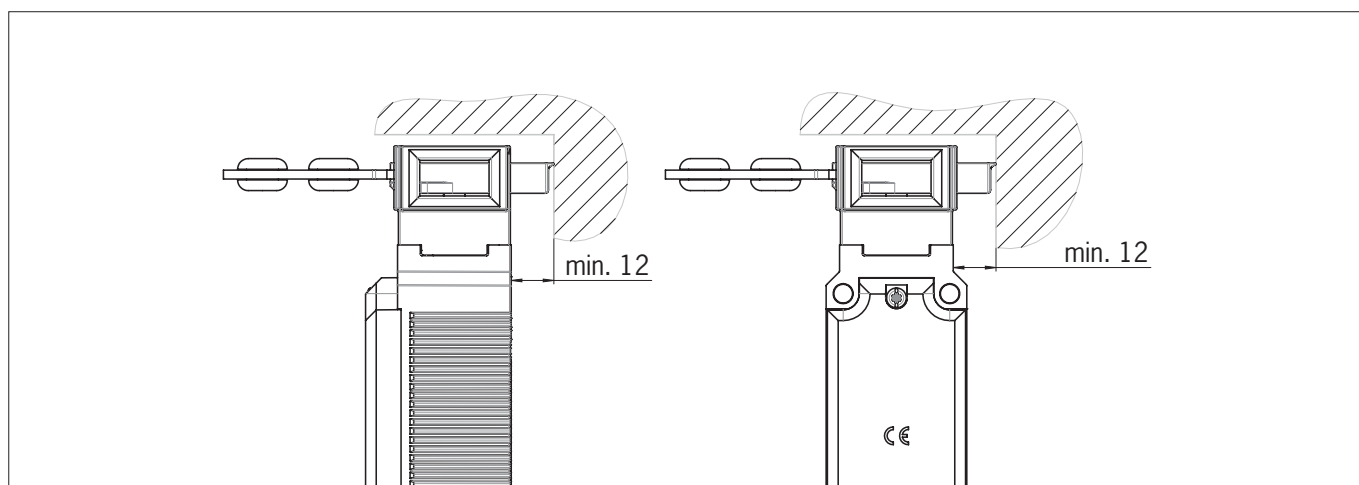

Fig. 2: Actuator head clearance

9. Electrical connection



WARNING

In the event of a fault, loss of the safety function due to incorrect connection.

- › To ensure safety, both safety outputs FO1A and FO1B must always be evaluated.
- › Monitoring outputs must not be used as safety outputs.
- › Lay the connecting cables with protection to prevent short circuits.



CAUTION

Risk of damage to equipment or malfunctions as a result of incorrect connection.

- › Do not use a control system with pulsing or switch off the pulsing function in your control system. The device generates its own test pulses on the safety outputs. A downstream control system must tolerate these test pulses, which may have a length of up to 300 μ s. Depending on the inertia of the downstream device (control system, relay, etc.), this can lead to short switching processes. The test pulses are output only with the safety outputs switched off during device start.
- › The inputs on an evaluation unit connected must be positive-switching, as the two outputs on the safety switch deliver a level of +24 V in the switched-on state.
- › All the electrical connections must either be isolated from the mains supply by a safety transformer according to IEC 61558-2-6 with limited output voltage in the event of a fault, or by other equivalent insulation measures (PELV).
- › All electrical outputs must have an adequate protective circuit for inductive loads. The outputs must be protected with a free-wheeling diode for this purpose. RC interference suppression units must not be used.
- › Power devices which are a powerful source of interference must be installed in a separate location away from the input and output circuits for signal processing. The cable routing for safety circuits should be as far away as possible from the cables of the power circuits.
- › To avoid EMC interference, the physical environmental and operating conditions at the installation site of the device must comply with the requirements according to the standard EN 60204-1 (EMC).
- › Pay attention to any interference fields from devices such as frequency converters or induction heating systems. Observe the EMC instructions in the manuals from the respective manufacturer.





Important!

If the device does not appear to function when operating voltage is applied (e.g. green STATE LED does not flash), the safety switch must be returned unopened to the manufacturer.

9.1. Notes about



Important!

- › This device is intended to be used with a Class 2 power source in accordance with UL1310. As an alternative an LV/C (Limited Voltage/Current) power source with the following properties can be used:
 - This device shall be used with a suitable isolating source in conjunction with a fuse in accordance to UL248. The fuse shall be rated max. 3.3 A and be installed in the 30 V DC power supply to the device as per the UL requirements. Please note possibly lower connection ratings for your device (refer to the technical data).
- › For use and application as per the requirements of UL ¹⁾ a connecting cable listed under the UL category code CYJV/7, min. 24 AWG, min. 80 °C, must be used.

1) Note on the scope of the UL approval: the devices have been tested as per the requirements of UL508 and CSA/ C22.2 no. 14 (protection against electric shock and fire).

9.2. Safety in case of faults

- › The safety outputs F01A/F01B are short circuit-proof.
- › A short circuit between the safety outputs is detected on starting or when the safety outputs are activated by the device.
- › A short circuit in the cable can be excluded by laying the cable with protection.

9.3. Fuse protection for power supply

The power supply must be provided with fuse protection depending on the number of switches and the current required for the outputs. The following rules apply:

Max. current consumption of an individual switch I_{max}

$$I_{max} = I_{UB} + I_{F01A+F01B} + I_{OX}$$

$$I_{UB} = \text{Switch operating current (40 mA)}$$

$$I_{OX} = \text{Load current of monitoring output (max. 10 mA per monitoring output)}$$

$$I_{F01A+F01B} = \text{Load current of safety outputs F01A + F01B (2 x max. 100 mA)}$$



Important!

If there are further monitoring outputs, their load current must be taken into account.

9.4. Requirements for connecting cables



CAUTION

Risk of damage to equipment or malfunctions as a result of incorrect connecting cables.

- › Use connection components and connecting cables from EUCHNER.
- › On the use of other connection components, the requirements in the following table apply. EUCHNER provides no warranty for safe function in case of failure to comply with these requirements.

Observe the following requirements with respect to the connecting cables:

For safety switch CTP-...-BP-...-SA-... with plug connector M12, 8-pin

Parameter	Value	Unit
Conductor cross-section, min.	0.25	mm ²
R max.	60	Ω/km
C max.	120	nF/km
L max.	0.65	mH/km
Recommended cable type	LIYY 8 x 0.25 mm ²	

9.5. Connector assignment of safety switch CTP-...-BP-...-SA-... with plug connector M12, 8-pin

Plug connector (view of connection side)	Pin	Designation	Function	Conductor coloring of connecting cable ¹⁾
<p>1 x M12</p>	1	-	n.c.	WH
	2	UB	Electronics operating voltage, 24 V DC	BN
	3	F01A	Safety output, channel A	GN
	4	F01B	Safety output, channel B	YE
	5	O/C	Diagnostic monitoring output/communication	GY
	6	OD	Door position monitoring output	PK
	7	0 V	Electronics operating voltage, 0 V DC	BU
	8	-	n.c.	RD

1) Only for standard EUCHNER connecting cable

9.6. Connection

The device is connected as shown in Fig. 3. The monitoring outputs can be routed to a control system.



WARNING

In the event of a fault, loss of the safety function due to incorrect connection.
 › To ensure safety, both safety outputs FO1A and FO1B must always be evaluated.



Important!

› The example shows only an excerpt that is relevant for connection of the CTP system. The example illustrated here does not show complete system planning. The user is responsible for safe integration into the overall system. Detailed application examples can be found at www.euchner.com. Simply enter the order number of your switch in the search box. You will find all available connection examples for the device in *Downloads*.

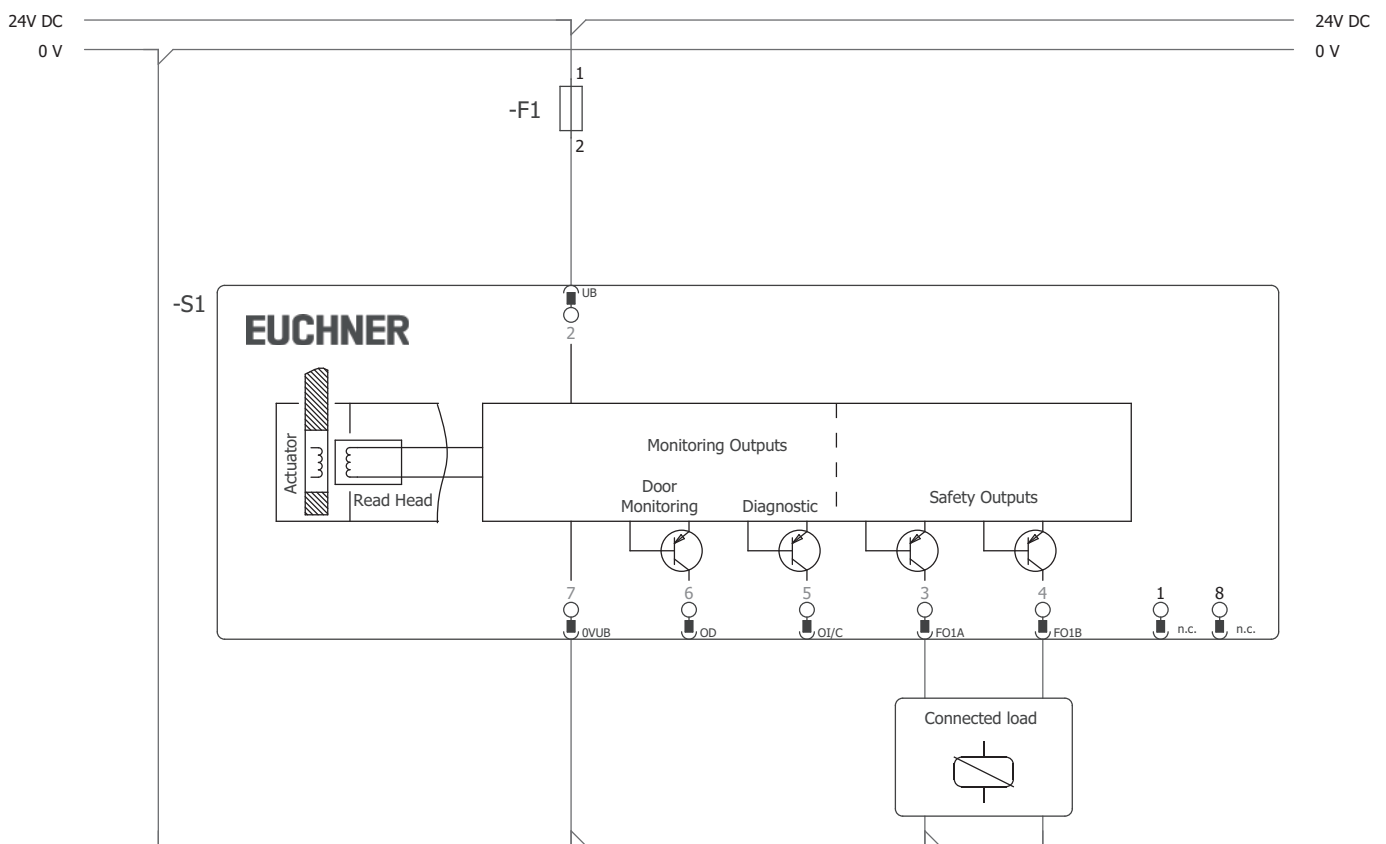

Fig. 3: Connection example

9.7. Notes on operation with safe control systems

Observe the following guidelines for connection to safe control systems:

- › Use a common power supply for the control system and the connected safety switches.
- › A pulsed power supply must not be used for UB. Tap the supply voltage directly from the power supply unit. If the power supply is connected to a terminal of a safe control system, this output must provide sufficient electrical current.
- › The safety outputs F01A and F01B can be connected to the safe inputs of a control system. Prerequisite: the input must be suitable for pulsed safety signals (OSSD signals, e.g. from light grids). The control system must tolerate test pulses on the input signals. This normally can be set up by parameter assignment in the control system. Observe the notes of the control system manufacturer. For the test pulse duration of your safety switch, refer to chapter 13. *Technical data on page 20.*

A detailed example of connecting and setting the parameters of the control system is available for many devices at www.euchner.com, in the area *Downloads/Applications/CTP....* The features of the respective device are dealt with there in greater detail.

10. Using communication data

A BR/IO-Link Gateway is required to use the device's communication data and forward them to a higher-level bus system. The following devices are suitable:

- GWY-CB-1-BR-IO (BR/IO-Link Gateway)
- ESM-CB (safety relay with integrated BR/IO-Link Gateway)

10.1. Connection to a BR/IO-Link Gateway GWY-CB

The Gateway is an IO-Link device. Communication via IO-Link offers cyclical (process data) and acyclical (device data and events) data exchange (see chapter 10.3. Overview of the communication data on page 15).

The communication connection C on the device allows the diagnostic line to be connected to the Gateway. The Ox/C connection represents a non-safety-related communication channel between the Gateway and the connected devices.

IO-Link communication can be used for the following functions as well:

- Reset for acknowledging error messages

You will find further information in the operating instructions for your BR/IO-Link Gateway.

10.2. Connection to a safety relay ESM-CB

The safety relay ESM-CB features an integrated BR/IO-Link Gateway. In addition to functioning as an IO-Link device (see chapter 10.1. Connection to a BR/IO-Link Gateway GWY-CB on page 15), the device can be used for connecting two monitored single- or dual-channel sensor circuits. The sensor circuits evaluate various signaling devices:

- Sensor circuit S1 with short circuit detection; suitable for single- or dual-channel safety sensors
- Sensor circuit S2, suitable for OSSD signals; short circuit detection by signaling device

When at least one sensor circuit is interrupted, the safety relay initiates the safe state. Different relay starting behaviors and various monitoring functions are possible.

The device's safety outputs FO1A and FO1B are routed to the OSSD inputs of the safety relay. The OD/C connection of the device allows the diagnostic line to be connected to the Gateway.

You will find further information in the operating instructions for your safety relay with integrated BR/IO-Link Gateway.

10.3. Overview of the communication data

The switch transmits both process data that are continuously transmitted to the evaluation unit (cyclical data) and data that can be polled specifically as needed (acyclical data). For further information on connection and on the communication data, refer to the operating instructions for your BR/IO-Link Gateway.

10.3.1. Cyclical data (process data)

Table 2: Cyclical data (process data)

	Bit 7	Bit 6	Bit 5	Bit 4	Bit 3	Bit 2	Bit 1	Bit 0
Byte 1	OI	-	OER	-	OM	OQ	-	OD
Byte 2	S1	S2	S3	-	OLS	-	OL	-

Table 3: Status and control data

	Bit 7	Bit 6	Bit 5	Bit 4	Bit 3	Bit 2	Bit 1	Bit 0
Byte 1	H1	H2	H3	H1_B	H2_B	H3_B	-	-

Extended version

10.3.2. Acyclical data (device data and events)

After one of the commands listed below is sent, the requested data are provided via the IO-Link Gateway.

The following applies to CTP devices of version V1.3.X: The reply message always consists of 8 bytes in big endian format.

Example 1: reply message in response to the command *Send device ID number/serial number*: 06 **02 68 E0 00 01 17 00**

In this example, the device's ID number is **157920** and its serial number is **279**.

Byte number	Byte 0	Byte 1	Byte 2	Byte 3	Byte 4	Byte 5	Byte 6	Byte 7
Reply in hex	06	02	68	E0	00	01	17	00
Description	User data length in bytes	Device ID number			Serial number		Padding data	
Reply in dec.	6 bytes	157920			279		-	

Command		Reply		
HEX	Meaning	Number of bytes	Bit sequences (big endian format)	
2	Send device ID number/serial number	6	Bytes 1 - 3	Device ID number
			Bytes 4 - 6	Serial number
3	Send version number of the device	5	Byte 1	{V}
			Bytes 2 - 4	Version number
5	Send number of devices in series connection	1		
A	Flashing frequency and position LED	1	Only on EXTENDED variants	
11	Send number of switching cycles (solenoid)	3		
12	Send current error code	1		
13	Send most recently saved error code	1		
14	Send size of log file	1		
15	Send entry from log file with index	1		
16	Send current actuator code	5	Bytes 3 - 4	
17	Send taught-in actuator code	5	Bytes 3 - 4	
18	Send disabled actuator code	5	Bytes 3 - 4	
19	Send applied voltage in mV	2		
1 A	Send current temperature in °C	1		
1B	Send number of switching cycles	3		
1D	Reset for acknowledging error messages	-		
1E	Factory reset	1	0x1E – Factory reset performed	

For more information on these and other acyclical data, refer to the operating instructions for your BR/IO-Link Gateway.

11. Setup

11.1. LED displays

You will find a detailed description of the signal functions in chapter 12. *System status table CTP-I-BP on page 19.*

LED	Color
STATE	green
DIA	red

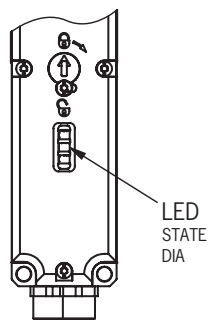

11.2. Teaching-in actuator (only for unicode evaluation)

The actuator must be allocated to the safety switch using a teach-in function before the system forms a functional unit.

During a teach-in operation, the safety outputs are switched off, i.e. the system is in the safe state.

The teach-in operation starts automatically. The number of possible teach-in operations is unlimited.



Tip!

Prior to switching on, close the guard on which the actuator to be taught-in is installed. The teach-in operation starts immediately after switching on. This simplifies above all teach-in with large installations.



Important!

- › The teach-in operation can be performed only if the device does not have any internal fault.
- › Devices in the condition as supplied remain in teach-in standby state until they have successfully taught-in the first actuator. Once taught-in, switches remain in the teach-in standby state for approx. 3 min. after each switch-on.
- › The safety switch disables the code of the preceding device if teach-in is carried out for a new actuator. Teach-in is not possible again immediately for this device if a new teach-in operation is carried out. The disabled code is released again in the safety switch only after a third code has been taught-in.
- › The safety switch can be operated only with the last actuator taught-in.
- › If the switch detects the actuator that was most recently taught-in when in the teach-in standby state, this state is ended immediately and the switch changes to normal operation.
- › The actuator to be taught-in is not activated if it is within the actuating range for less than 30 s.

1. Establish teach-in standby:

- Devices in the condition as supplied: unlimited teach-in standby after switching on.
- Switch already taught-in: teach-in standby is available for approx. 3 min after switching on.

➔ Teach-in standby indication, STATE LED flashes 3x repeatedly.

2. Insert the actuator during teach-in standby.

➔ The automatic teach-in operation starts (duration approx. 30 s).

During the teach-in operation the STATE LED flashes (approx. 1 Hz).

Alternate flashing of the STATE and DIA LEDs acknowledges the successful teach-in operation.

Teach-in errors are indicated by the illumination of the red DIA LED and a flashing code on the green STATE LED (see chapter 12. *System status table CTP-I-BP on page 19*).

3. Switch off operating voltage (min. 3 s).

➔ The code of the actuator that was just taught-in is activated in the safety switch.

4. Switch on operating voltage.

➔ The device operates normally.

11.3. Functional check



WARNING

Danger of fatal injury as a result of faults in installation and functional check.

- › Before carrying out the functional check, make sure that there are no persons in the danger zone.
- › Observe the valid accident prevention regulations.

11.3.1. Mechanical function test

The actuator must slide easily into the actuating head. Close the guard several times to check the function.

11.3.2. Electrical function test

After installation and after any fault, the safety function must be fully checked. Proceed as follows:

1. Switch on operating voltage.

- ➔ The machine must not start automatically.
- ➔ The safety switch carries out a self-test. The green STATE LED then flashes at regular intervals.

2. Close all guards.

- ➔ The machine must not start automatically.
- ➔ The green STATE LED illuminates continuously.

3. Enable operation in the control system.

4. Open the guard.

- ➔ The machine must switch off and it must not be possible to start it as long as the guard is open.

Repeat steps 2 - 4 for each guard.

11.4. Factory reset

Before switching on, connect the two outputs FO1A and FO1B to 0 V or set the bit 0x1E via IO-Link communication.

12. System status table CTP-I-BP

Operating mode	Actuator/door position	Safety outputs FO1A and FO1B 	Door position signal OD	LED indicator Output		State
				STATE (green)	DIA (red) and diagnostic signal OI	
Self-test	X	off	off	5 Hz	○	Self-test after power-up
	X	off	off	5 Hz	1 x	No communication with the BR/IO-Link Gateway
Normal operation	closed	on	on		○	Normal operation, door closed
	open	off	off	1 x	○	Normal operation, door open
Teach-in operation (only unicode)	open	off	off	3 x	○	Device in teach-in standby
	closed	off	on	1 Hz	○	Teach-in operation
	X	off	X	↔		Positive acknowledgment after completion of teach-in operation
Fault display	X	off	x	1 x		Error in the teach-in operation (only unicode) Actuator removed from the actuating range prior to the end of the teach-in operation or faulty actuator detected
	X	off	off	3 x		Read error (e.g. actuator faulty)
	X	off	off	4 x	1 x inverse	Output fault (e.g. short circuit, loss of switching ability)
	X	off	X	5 x		Disabled actuator detected/environment error
	X	off	off	○		Internal fault/plausibility error
Key to symbols				○		LED not illuminated
						LED illuminated
				1 x inverse		LED illuminated, briefly goes off 1 x
				5 Hz		LED flashes at 5 Hz
				3 x		LED flashes three times, and this is then repeated
				↔		LEDs flash alternately
				X		Any state

When DIA flashes inversely once, the fault display can generally be reset by opening and closing the guard after remedying the cause. If the fault is still displayed afterward, as well as for all other fault displays, briefly interrupt the power supply. Contact the manufacturer if the fault display is not reset after restarting.



Important!

If you do not find the displayed device status in the system status table, this indicates an internal device fault. In this case, contact the manufacturer.

13. Technical data



NOTICE

If a data sheet is available for the product, the information on the data sheet applies.

13.1. Technical data for safety switch CTP-I-BP

Parameter	Value			Unit
	min.	typ.	max.	
General				
Material - Switch head - Switch housing	Die-cast zinc Reinforced thermoplastic			
Installation orientation	Any			
Degree of protection	IP65/IP67/IP69/IP69K (screwed tight with the related mating connector)			
Safety class acc. to EN IEC 61558	III			
Degree of contamination	3			
Mechanical life	1 x 10 ⁶ operating cycles			
Ambient temperature at U _B = 24 V	-20	-	+55	°C
Actuator approach speed, max.	20			m/min
Actuating/extraction force at 20 °C	10/20			N
Weight	Approx. 0.23			kg
Connection (depending on version)	Plug connector M12, 8-pin			
Operating voltage U _B (reverse polarity protected, regulated, residual ripple < 5%)	24 ±15% (PELV)			V DC
Current consumption I _{UB}	40			mA
The following applies to the approval acc. to UL	Operation only with UL Class 2 power supply or equivalent measures			
Switching load acc. to UL	24 V DC, Class 2			
External fuse (operating voltage U _B) ¹⁾	0.25	-	8	A
Rated insulation voltage U _i	-	-	50	V
Rated impulse withstand voltage U _{imp}	-	-	0.5	kV
Rated conditional short-circuit current	100			A
Shock and vibration resistance	Acc. to EN 60947-5-3			
EMC protection requirements	Acc. to EN 60947-5-3			
Ready delay	-	5	-	s
Risk time for single device	-	-	270	ms
Risk time extension per device	5			ms
Turn-on time	-	-	150	ms
Discrepancy time	-	-	10	ms
Test pulse duration	-	-	0.3	ms
Test pulse interval	100	-	-	ms
Safety outputs FO1A/FO1B Semiconductor outputs, p-switching, short circuit-proof				
- Output voltage U _{FO1A} /U _{FO1B} ²⁾				
HIGH U _{FO1A} /U _{FO1B}	U _B - 1.5	-	U _B	V DC
LOW U _{FO1A} /U _{FO1B}	0	-	1	
Switching current per safety output	1	-	100	mA
Utilization category acc. to EN 60947-5-2	DC-13 24V 100 mA Caution: outputs must be protected with a free-wheeling diode in case of inductive loads			
Switching frequency ³⁾	0.5			Hz
Monitoring outputs OI, OD p-switching, short circuit-proof				
Output voltage	0.8 x U _B	-	U _B	V DC
Max. load	-	-	10	mA
Reliability values acc. to EN ISO 13849-1⁴⁾				
Mission time	20			years
Monitoring of the guard position				
Category	4			
Performance Level (PL)	e			
PFD ₀	5.38 x 10 ⁻⁹ /h			

1) Trip characteristic medium slow-blow

2) Values at a switching current of 50 mA without taking into account the cable lengths

3) Corresponds to the actuation frequency

4) For the issue date, refer to the declaration of conformity in chapter 17

13.2. Typical system times

Refer to the technical data for the exact values.

Ready delay: After switch-on, the device carries out a self-test. The system is ready for operation only after this time.

Turn-on time of safety outputs: The max. reaction time t_{on} is the time from the moment when the guard is locked to the moment when the safety outputs switch on.

Risk time according to EN 60947-5-3: The risk time is the maximum time until at least one of the safety outputs F01A or F01B switches off safely when the actuator is removed from the actuating range. This also applies if an internal or external fault occurs at this moment.

Discrepancy time: The safety outputs F01A and F01B switch with a slight time offset. They have the same signal state no later than after the discrepancy time.

Test pulses at the safety outputs: The device generates its own test pulses on the safety outputs F01A and F01B. A downstream control system must tolerate these test pulses.

This can usually be set up in the control systems by parameter assignment. If parameter assignment is not possible for your control system or if shorter test pulses are required, contact our support organization.

The test pulses are also output when the safety outputs are switched off.

13.3. Radio frequency approvals

FCC ID: 2AJ58-13

IC: 22052-13



FCC/IC-Requirements

This device complies with part 15 of the FCC Rules and with Industry Canada's licence-exempt RSSs. Operation is subject to the following two conditions:

- 1) This device may not cause harmful interference, and
- 2) this device must accept any interference received, including interference that may cause undesired operation.

Changes or modifications not expressly approved by the party responsible for compliance could void the user's authority to operate the equipment.

NOTE: This equipment has been tested and found to comply with the limits for a Class A digital device, pursuant to part 15 of the FCC Rules. These limits are designed to provide reasonable protection against harmful interference when the equipment is operated in a commercial environment. This equipment generates, uses, and can radiate radio frequency energy and, if not installed and used in accordance with the instruction manual, may cause harmful interference to radio communications.

Operation of this equipment in a residential area is likely to cause harmful interference in which case the user will be required to correct the interference at his own expense.

Le présent appareil est conforme aux CNR d'Industrie Canada applicables aux appareils radio exempts de licence. L'exploitation est autorisée aux deux conditions suivantes :

- (1) l'appareil ne doit pas produire de brouillage, et
- (2) l'utilisateur de l'appareil doit accepter tout brouillage radioélectrique subi, même si le brouillage est susceptible d'en compromettre le fonctionnement.

Supplier's Declaration of Conformity

47 CFR § 2.1077 Compliance Information

Unique Identifier:

CTP-I-AR SERIES
CTP-I1-AR SERIES
CTP-I2-AR SERIES
CTP-IBI-AR SERIES
CTP-L1-AR SERIES
CTP-L2-AR SERIES
CTP-LBI-AR SERIES
CTP-I-AP SERIES
CTP-I1-AP SERIES
CTP-I2-AP SERIES
CTP-IBI-AP SERIES
CTP-L1-AP SERIES
CTP-L2-AP SERIES
CTP-LBI-AP SERIES
CTA-BR SERIES
CTA-BP SERIES
CTP-BR SERIES
CTP-BP SERIES

Responsible Party – U.S. Contact Information

EUCHNER USA Inc.

1860 Jarvis Avenue
Elk Grove Village, Illinois 60007

+1 315 701-0315
info(at)euchner-usa.com
<http://www.euchner-usa.com>

13.4. Dimension drawing for safety switch CTP...

Version with plug connector M12

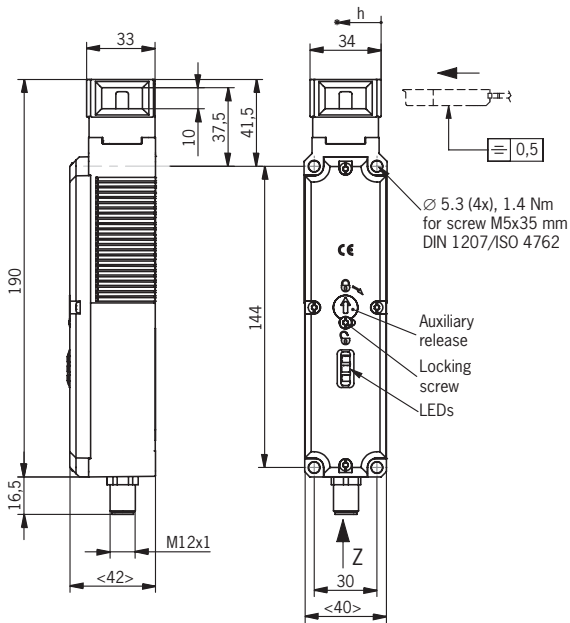

Necessary minimum travel + permissible overtravel

Approach direction	Standard actuator
Horizontal (h)	40 + 5

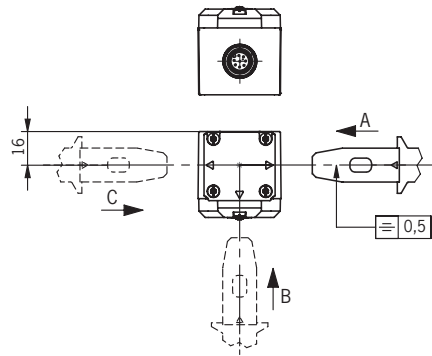

Cable outlet C

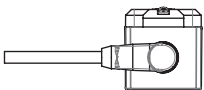

Cable outlet A

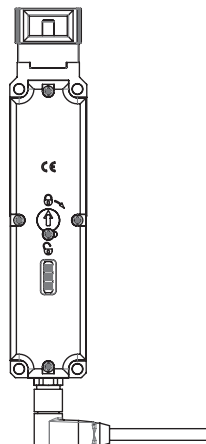
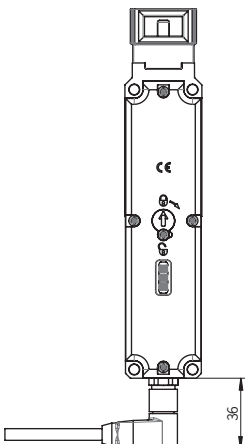
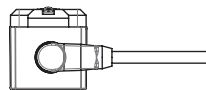

13.5. Technical data for actuator CTP-...

Parameter	Value			Unit
	min.	typ.	max.	
Housing material	Fiber reinforced plastic			
Weight	0.03 ... 0.06 (depending on version)			kg
Ambient temperature	-20	-	+55	°C
Degree of protection	IP65/IP67/IP69/IP69K			
Mechanical life	1 x 10 ⁶			
Installation orientation	Any			
Power supply	Inductive via read head			

13.5.1. Dimension drawing for actuator CTP-...

Dimension drawing	Min. door radius [mm]	Order no./item
<p style="writing-mode: vertical-rl; transform: rotate(180deg);">Straight actuators</p> <p>Color: red</p>		<p>126015 A-C-H-G-SST-126015</p>

	Dimension drawing	Min. door radius [mm]	Order no./item
Bent actuators	<p>Bent, upward</p>		<p>122667 A-CHW-SST-122667</p>
	<p>Bent, downward</p>		<p>122668 A-CHW-SST-122668</p>

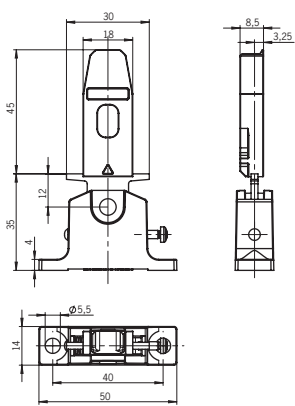
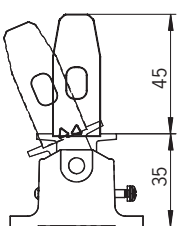
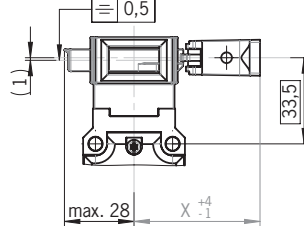
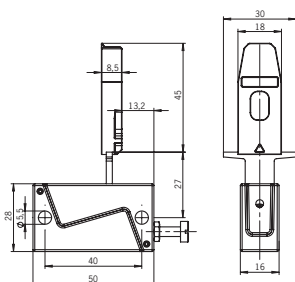
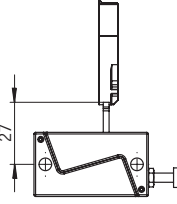
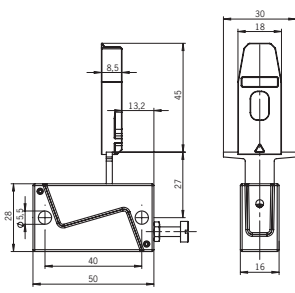
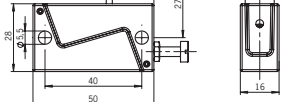
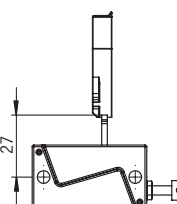
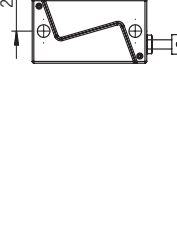
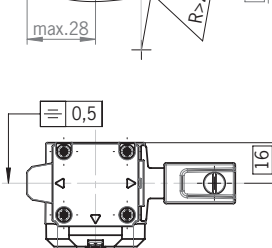
Dimension drawing		Min. door radius [mm]	Order no./item
		 <p>X = 53 mm (122671, 122672) X = 49 mm (122669, 122670)</p>	<p>122671 A-C-HRL-LS-122671</p>
			<p>122672 A-C-HRR-LS-122672</p>
<p style="writing-mode: vertical-rl; transform: rotate(180deg);">Hinged actuators</p> 		 <p>X = 41 mm (122673, 122674) X = 45 mm (122675, 122676)</p>	<p>122675 A-C-HRO-LS-122675</p>
		 <p>X = 41 mm (122673, 122674) X = 45 mm (122675, 122676)</p>	<p>122676 A-C-HRULS-122676</p>



Tip!

The actuator is supplied with screws that cannot easily be unscrewed with a tool.

14. Ordering information and accessories



Tip!

Suitable accessories, e.g. cables or assembly material, can be found at www.euchner.com. To order, enter the order number of your item in the search box and open the item view. Accessories that can be combined with the item are listed in *Accessories*.

15. Inspection and service



WARNING

Danger of severe injuries due to the loss of the safety function.

- › If damage or wear is found, the complete switch and actuator assembly must be replaced. Replacement of individual parts or assemblies is not permitted.
- › Check the device for proper function at regular intervals and after every fault. For information about possible time intervals, refer to EN ISO 14119:2013, section 8.2.

Regular inspection of the following is necessary to ensure trouble-free long-term operation:

- › Check the switching function (see chapter 11.3. *Functional check on page 18*)
- › Check all additional functions (e.g. escape release, lockout bar, etc.)
- › Check the secure mounting of the devices and the connections
- › Check for contamination

No servicing is required. Repairs to the device are only allowed to be made by the manufacturer.



NOTICE

The year of manufacture is given in the laser marking at the bottom right corner. The current version number in the format (V X.X.X) can also be found on the device.

16. Service

If servicing is required, please contact:

EUCHNER GmbH + Co. KG
Kohlhammerstraße 16
70771 Leinfelden-Echterdingen
Germany

Service telephone:

+49 711 7597-500

E-mail:

support@euchner.de

Internet:

www.euchner.com

17. Declaration of conformity

The declaration of conformity is part of the operating instructions.

The complete EU declaration of conformity can also be found at www.euchner.com. Enter the order number of your device in the search box. The document is available under *Downloads*.

EUCHNER GmbH + Co. KG
Kohlhammerstraße 16
70771 Leinfelden-Echterdingen
Germany
info@euchner.de
www.euchner.com

Edition:
MAN20001422-03-03/23
Title:
Operating Instructions Transponder-Coded Safety Switch
CTP-I-BP
(translation of the original operating instructions)
Copyright:
© EUCHNER GmbH + Co. KG, 03/2023

Subject to technical modifications; no responsibility is accepted for the accuracy of this information.