

EUCHNER

Operating Instructions

Transponder-Coded Safety Switch with Guard Locking
CTM-LBI-BP/BR Unicode/Multicode
with Control of Guard Locking via Control Input IMP

EN

Contents

| | | |
|-----------|---|-----------|
| 1. | About this document | 4 |
| 1.1. | Scope..... | 4 |
| 1.2. | Target group | 4 |
| 1.3. | Key to symbols..... | 4 |
| 1.4. | Supplementary documents | 4 |
| 2. | Correct use | 5 |
| 3. | Description of the safety function | 6 |
| 4. | Exclusion of liability and warranty | 8 |
| 5. | General safety precautions | 8 |
| 6. | Function | 9 |
| 6.1. | Bistable guard locking..... | 9 |
| 6.2. | Guard lock monitoring | 9 |
| 6.3. | Monitoring outputs/status bits | 9 |
| 6.3.1. | Door position signal OD..... | 9 |
| 6.3.2. | Diagnostic signal OI | 9 |
| 6.3.3. | Guard locking signal OL | 10 |
| 6.3.4. | Status signal OM..... | 10 |
| 6.3.5. | Locking element signal OLS..... | 10 |
| 6.3.6. | Communication connection C..... | 10 |
| 6.4. | Guard locking | 10 |
| 6.5. | Switching states | 11 |
| 7. | Manual release | 12 |
| 7.1. | Auxiliary release..... | 12 |
| 8. | Mounting | 13 |
| 9. | Electrical connection | 14 |
| 9.1. | Notes about  | 15 |
| 9.2. | Safety in case of faults..... | 15 |
| 9.3. | Fuse protection for power supply | 15 |
| 9.4. | Requirements for connecting cables..... | 16 |
| 9.5. | Connector assignments..... | 16 |
| 9.5.1. | Connector assignment of safety switch CTM-...-BP-...-SA-166089/166090 with plug connector M12, 8-pin | 16 |
| 9.5.2. | Connector assignment of safety switch CTM-...-BP-...-SA-166087/166088 with plug connector M12, 8-pin | 16 |
| 9.5.3. | Connector assignment/terminal assignment of safety switches CTM-...-BR-...-SA-... with plug connector M12, 8-pin CTM-...-BR-...-V05-... with connecting cable, 8-core | 17 |
| 9.5.4. | Connector assignment of safety switch CTM-...-BR-...-SP-... with plug connector M12, 12-pin.... | 17 |
| 9.6. | Notes on operation with safe control systems..... | 18 |
| 9.7. | Connection without and with IO-Link communication..... | 18 |
| 9.7.1. | Connection without IO-Link communication | 18 |
| 9.7.2. | Connection with IO-Link communication..... | 18 |

| | | |
|------------|---|-----------|
| 10. | Connection of a single CTM-BP/BR (separate operation) | 19 |
| 11. | Connection of several devices in a chain (series connection) | 21 |
| 11.1. | Series connection with wiring in the control cabinet | 21 |
| 11.2. | Series connection with Y-distributors | 21 |
| 11.2.1. | Maximum cable lengths with BR switch chains | 22 |
| 11.2.2. | Determining cable lengths | 22 |
| 11.2.3. | Connector assignment of Y-distributor for series connection without O-Link communication | 23 |
| 12. | Using communication data | 25 |
| 12.1. | Connection to a BR/IO-Link Gateway GWY-CB..... | 25 |
| 12.2. | Connection to a safety relay ESM-CB..... | 25 |
| 12.3. | Overview of the communication data | 25 |
| 12.3.1. | Cyclical data (process data)..... | 25 |
| 12.3.2. | Acyclical data (device data and events)..... | 26 |
| 13. | Setup | 27 |
| 13.1. | Teaching-in actuator (only for unicode evaluation) | 27 |
| 13.2. | Functional check..... | 28 |
| 13.2.1. | Mechanical function test..... | 28 |
| 13.2.2. | Electrical function test..... | 28 |
| 14. | Factory reset | 28 |
| 15. | Status and error messages | 29 |
| 15.1. | LED displays | 29 |
| 15.2. | Status messages..... | 30 |
| 15.3. | Error messages..... | 31 |
| 15.4. | Acknowledging error messages..... | 32 |
| 16. | Technical data | 33 |
| 16.1. | Technical data for safety switch CTM-LBI | 33 |
| 16.1.1. | Typical system times..... | 34 |
| 16.2. | Radio frequency approvals..... | 35 |
| 16.3. | Dimension drawing for safety switch CTM... .. | 36 |
| 16.4. | Technical data for actuator A-B-A1-A1-..... | 37 |
| 16.4.1. | Dimension drawing for actuator A-B-A1-A1-... .. | 37 |
| 16.5. | Technical data for actuator A-B-A5-A1-..... | 38 |
| 16.5.1. | Dimension drawing for actuator A-B-A5-A1-... .. | 38 |
| 17. | Ordering information and accessories | 39 |
| 18. | Inspection and service | 39 |
| 19. | Service | 39 |
| 20. | Declaration of conformity | 39 |

1. About this document

1.1. Scope

These operating instructions are valid for all CTM-LBI-BP/BR... with Control of Guard Locking via Control Input IMP from version V1.0.X to version V1.3.X. These operating instructions, the document *Safety information* and any available data sheet form the complete user information for your device.

These operating instructions are not valid for safety switches CTM-LBI-BP/BR-...D... with control of guard locking via IO-Link. The MAN20001661 operating instructions are valid for these devices.



Important!

Make sure to use the operating instructions valid for your product version. Please contact the EUCHNER support team if you have any questions.

1.2. Target group

Design engineers and installation planners for safety devices on machines, as well as setup and servicing staff possessing special expertise in handling safety components.

1.3. Key to symbols

| Symbol/depiction | Meaning |
|---|--|
| | Printed document |
| | Document is available for download at www.euchner.com |
| DANGER WARNING CAUTION | Safety precautions Danger of death or severe injuries Warning about possible injuries Caution slight injuries possible |
| NOTICE Important! | Notice about possible device damage Important information |
| Tip | Useful information |

1.4. Supplementary documents

The overall documentation for this device consists of the following documents:

| Document title (document number) | Contents | |
|-------------------------------------|---|------|
| Safety information (2525460) | Basic safety information | |
| Operating instructions (2525462) | (this document) | |
| Declaration of conformity | Declaration of conformity | |
| Possibly available data sheet | Item-specific information about deviations or additions | |



Important!

Always read all documents to gain a complete overview of safe installation, setup and use of the device. The documents can be downloaded from www.euchner.com. For this purpose enter the doc. no. in the search box.

2. Correct use

Safety switches series CTM-LBI-BP/BR... with Control of Guard Locking via Control Input IMP are interlocking devices with guard locking solenoid (type 4). The device complies with the requirements according to EN 60947-5-3. Devices with unicode evaluation possess a high coding level, devices with multicode evaluation possess a low coding level.

In combination with a movable guard and the machine control, this safety component prevents the guard from being opened while a dangerous machine function is being performed.

This means:

- › Starting commands that cause a dangerous machine function must become active only when the guard is closed and locked.
- › The guard locking must not be released until the dangerous machine function has ended.
- › Closing and locking a guard must not cause automatic starting of a dangerous machine function. A separate start command must be issued. For exceptions, refer to EN ISO 12100 or relevant C-standards.

Devices from this series are also suitable for process protection.

Before the device is used, a risk assessment must be performed on the machine, e.g. in accordance with the following standards:

- › EN ISO 13849-1
- › EN ISO 12100
- › IEC 62061

Correct use includes observing the relevant requirements for installation and operation, particularly based on the following standards:

- › EN ISO 13849-1
- › EN ISO 14119
- › EN 60204-1

The safety switch is allowed to be operated only in conjunction with the intended EUCHNER actuators and the related connection components from EUCHNER. If different actuators or other connection components are used, EUCHNER provides no warranty for safe function.

Safety switches in the version CTM-...-BR can be integrated into a BR device chain. Connection of several devices in a BR switch chain is permitted only using devices intended for series connection in a BR switch chain. Check this in the specifications of the device in question.



Important!

- › The user is responsible for the proper integration of the device into a safe overall system. For this purpose, the overall system must be validated, e.g. in accordance with EN ISO 13849-1.
- › It is only allowed to use components that are permissible in accordance with the table below.

Table 1: Possible combinations for CTM components

| Safety switch | Actuator | |
|---------------------------|------------|----------------------|
| | A-B-A1-... | A-B-A5-... |
| CTM-... Unicode/Multicode | ● | ● |
| Key to symbols | ● | Combination possible |

3. Description of the safety function

Devices from this series feature the following safety functions:

Monitoring of guard locking and the position of the guard (interlocking device with guard locking according to EN ISO 14119)

- › Safety function (see chapter 6.5. *Switching states on page 11*):
 - The safety outputs are switched off when guard locking is released (monitoring of the locking element).
 - The safety outputs are switched off when the guard is open (monitoring of the door position).
- › Safety characteristics: category, Performance Level, PFH_D (see chapter 16. *Technical data on page 33*).

The following additionally applies in a BR series connection:

- › The safety outputs are switched on only when the device receives a corresponding signal from its predecessor in the chain.



NOTICE

You can regard the complete BR device chain as one subsystem during calculation. The following calculation method applies to the PFH_D value:

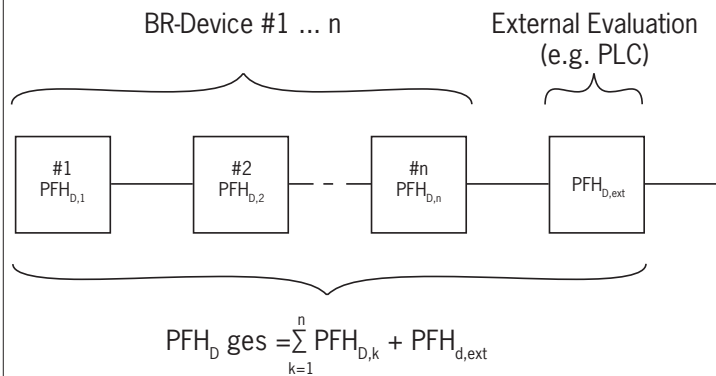

Control of guard locking for variants with IMP/IMM connection

If the device is used as guard locking for personnel protection, control of guard locking must be regarded as a safety function.

The safety level of guard locking control is determined by the device $PFHD_{int.}$ and by the external control (e.g. $PFHD_{ext.}$ of the standstill monitor), but cannot be higher than PL d.

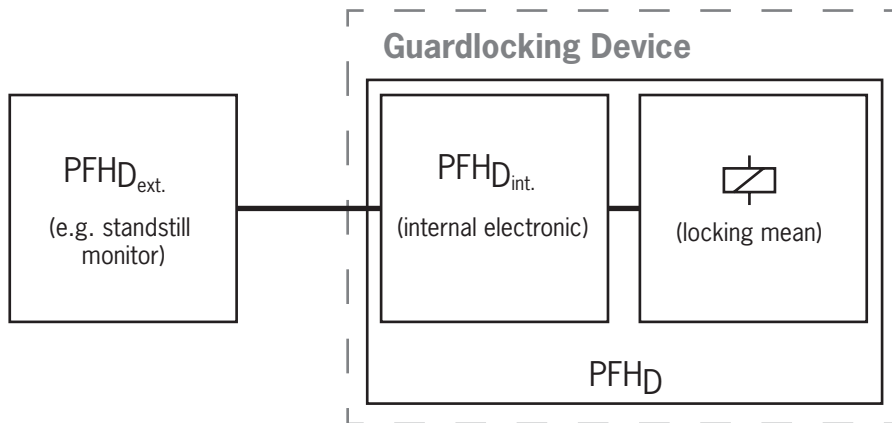

Safety characteristics: category, Performance Level, $PFHD$ (see chapter 16. *Technical data on page 33*).

- › Safety function
 - Guard locking remains activated until IMP requests releasing the guard locking.

The decisive criterion for a possible request to deactivate guard locking is a voltage of at least 20.4 V between the inputs IMP and 0 V or between IMP and IMM.

The external control system must recognize and react to short circuits on these control signals. Fault exclusion, e.g. by laying the cables with protection, can be considered as an alternative.

4. Exclusion of liability and warranty

In case of failure to comply with the conditions for correct use stated above, or if the safety regulations are not followed, or if any servicing is not performed as required, liability will be excluded and the warranty void.

5. General safety precautions

Safety switches fulfill personnel protection functions. Incorrect installation or tampering can lead to fatal injuries to personnel.

Check the safe function of the guard particularly

- › after any setup work
- › after the replacement of a system component
- › after an extended period without use
- › after every fault

Independent of these checks, the safe function of the safeguard must be checked at suitable intervals as part of the maintenance schedule.



WARNING

Danger to life due to improper installation or due to bypassing (tampering). Safety components fulfill a personnel protection function.

- › Safety components must not be bypassed, turned away, removed or otherwise rendered ineffective. On this topic pay attention in particular to the measures for reducing the possibility of bypassing according to EN ISO 14119:2013, section 7.
- › The switching operation must be triggered only by actuators designated for this purpose.
- › Prevent bypassing by means of replacement actuators (only for multicode evaluation). For this purpose, restrict access to actuators and to keys for releases, for example.
- › Damaged actuators can lead to limited prevention of inadvertent locking position (faulty closure protection) when the machine is switched on. The guard locking function can no longer be ensured if an actuator is broken. Opening the door will immediately switch off the safety outputs. Regularly check the actuator for mechanical damage.
- › Mounting, electrical connection and setup only by authorized personnel possessing the following knowledge:
 - specialist knowledge in handling safety components
 - knowledge about the applicable EMC regulations
 - knowledge about the applicable regulations on operational safety and accident prevention.



Important!

Prior to use, read the operating instructions and keep these in a safe place. Ensure the operating instructions are always available during mounting, setup and servicing. You can download the operating instructions from www.euchner.com.

6. Function

The device permits the locking of movable guards.

The system consists of the following components: coded actuator (transponder) and switch.

Whether the device learns the complete actuator code (unicode) or not (multicode) depends on the respective version.

- › **Devices with unicode evaluation:** The actuator must be assigned to the safety switch by a teach-in operation so that it is detected by the system. This unambiguous assignment ensures a particularly high level of protection against tampering. The system thus possesses a high coding level.
- › **Devices with multicode evaluation:** Unlike systems with unicode evaluation, on multicode devices a specific code is not requested but instead it is only checked whether the actuator is of a type that can be detected by the system (multicode evaluation). There is no exact comparison of the actuator code with the taught-in code in the safety switch (unicode evaluation). The system possesses a low coding level.

When the guard is closed, the actuator is moved into the safety switch. Guard locking can be activated only when the actuator is located in the switch (prevention of inadvertent locking position (faulty closure protection)). When the operating distances are reached, power is supplied to the actuator by the switch and data are transferred.

The door position signal OD is set when a permissible code is detected. Guard locking is activated automatically if no voltage is present at control input IMP. The safety outputs are switched on when guard locking is active.

The safety outputs are switched off and the guard locking signal OL is cleared when guard locking is released.

In the event of a fault in the safety switch, the safety outputs are switched off and the DIA LED illuminates red. The occurrence of faults is detected at the latest on the next demand to close the safety outputs (e.g. on starting).

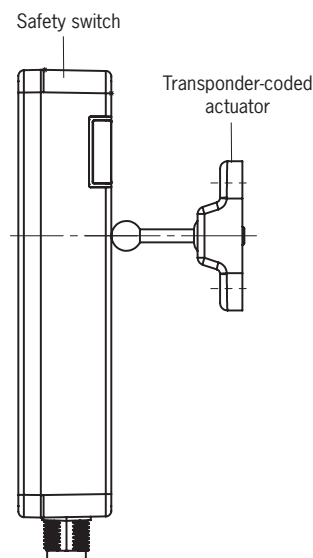

6.1. Bistable guard locking

Guard locking of the switch functions according to the bistable principle. This means that guard locking is kept in its last position if the switch's power supply is interrupted or when the machine is switched off for servicing, for example. As a result, the safety door is either constantly locked or it can be closed and opened as required without activating the guard locking. Guard locking is released via control input IMP. See also chapter 6.4. *Guard locking on page 10.*

6.2. Guard lock monitoring

All versions feature two safe outputs for monitoring guard locking. The safety outputs FO1A and FO1B are switched off when guard locking is released.

6.3. Monitoring outputs/status bits

Depending on version, the signals listed in the following are available as a status bit or at the monitoring output. The status bits are evaluated via the BR/IO-Link Gateway. Please refer to the corresponding data sheet for further information.

6.3.1. Door position signal OD

The door position signal is sent as soon as the actuator is inserted into the switch head (state: guard closed and not locked). The signal is also present if the guard locking is active.

6.3.2. Diagnostic signal OI

The diagnostic signal is present if there is an error (switch-on condition as for DIA LED).

6.3.3. Guard locking signal OL

The guard locking signal is present if the guard locking is active.

6.3.4. Status signal OM

The status signal is present if the device's safety outputs are switched.

6.3.5. Locking element signal OLS

The locking element signal is present if the locking element is stuck and guard locking cannot be released. The signal is reset as soon as the actuator is no longer under tensile stress or the locking element is no longer blocked.

6.3.6. Communication connection C

A monitoring output with the suffix C has the additional function of providing a communication connection to a BR/IO-Link Gateway. The switch delivers cyclical and acyclical data. You will find an overview of the communication data in chapter 12. *Using communication data on page 25.*

If no BR/IO-Link Gateway is connected, this output behaves like a monitoring output.

6.4. Guard locking

(guard locking actuated by spring force and released by power-ON)



Important!

Malfunctions due to incorrect use.

- › The actuator must not be under tensile stress during release.
- › Very strong jolts or vibration can cause the guard locking state to change unintentionally. This generally applies when the switch is electrically isolated.
 - The switch must not be used as a mechanical end stop.
 - In case of heavy doors, ensure that the impact energy is cushioned on closing.

The spring-operated guard locking functions in accordance with the closed-circuit current principle.

If the voltage is interrupted at the solenoid, the guard locking remains active and the guard cannot be opened directly.



Important!

If the guard is open when the power supply is interrupted and is then closed, guard locking remains released. This prevents people from being locked in unintentionally.



Control of guard locking via control input IMP

Activating guard locking: apply operating voltage UB, close guard; no voltage at control input IMP.

Releasing guard locking: apply voltage to control input IMP and apply operating voltage UB.

6.5. Switching states

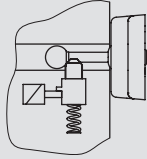
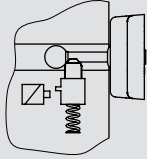
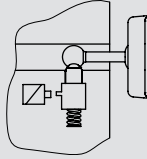
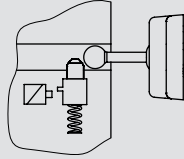
The detailed switching states for your switch can be found in chapter 15. *Status and error messages on page 29.* All safety outputs, signals and display LEDs are described there.

| | Guard closed and locked | Guard closed and not locked | Guard being opened | Guard open |
|---|---|---|--|---|
| |  |  |  |  |
| Control input IMP | off | on | on | off = Guard locking is activated immediately on closing on = Guard locking remains released on closing |
| Safety outputs F01A and F01B  | on | off | off | off |
| Guard locking signal OL | on | off | off | off |
| Door position signal OD | on | on | on | off |

7. Manual release



Important!

- › All release functions latch when the device is electrically isolated.
- › Guard locking remains released when the release function is reset.

Some situations require the guard locking to be released manually (e.g. malfunctions or an emergency). A function test must be performed after release.

Further information on this topic can be found in the standard EN ISO 14119:2013, section 5.7.5.1. The device can feature the following release functions:

7.1. Auxiliary release

In the event of malfunctions, the guard locking can be released with the auxiliary release irrespective of the state of the solenoid.



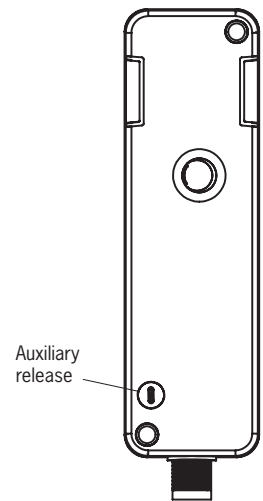

Important!

- › The actuator must not be under tensile stress during manual release.
- › To prevent tampering, the auxiliary release must be sealed with sealing lacquer, for example, before the switch is set up.
- › Loss of the release function due to mounting errors or damage during mounting.
- › Check the release function every time after mounting.
- › After manual release, the solenoid must be energized briefly to re-establish guard locking.
- › The auxiliary release is not a safety function.
- › The correct function must be checked at regular intervals.
- › Observe the notes on any available data sheets.



Actuating auxiliary release

1. Remove seal label or make a hole.
2. Using a screwdriver, turn the auxiliary release to  in the direction of the arrow.
 - ➔ Guard locking is released.
 - ➔ The safety outputs are switched off.
 - ➔ The guard locking signal OL is switched off. The diagnostic signal OI is switched on.
3. Using a screwdriver, turn the auxiliary release to  in the opposite direction to the arrow to reset.
4. Seal with sealing lacquer.
5. Close the guard.
6. Carry out reset; see *Plausibility errors* in chapter 15.3. *Error messages*.
 - ➔ The device operates normally again.
7. Check correct function of the device.

8. Mounting



CAUTION

Safety switches must not be bypassed (bridging of contacts), turned away, removed or otherwise rendered ineffective.

- › Observe EN ISO 14119:2013, section 7, for information about reducing the possibilities for bypassing an interlocking device.



NOTICE

Risk of damage to equipment and malfunctions as a result of incorrect installation.

- › Safety switches and actuators must not be used as an end stop.
- › Observe EN ISO 14119:2013, sections 5.2 and 5.3, for information about mounting the safety switch and the actuator.
- › Protect the switch against damage, as well as against penetrating foreign objects such as swarf, sand and blasting shot, etc.
- › Observe the min. door radii (see chapter 16.3. *Dimension drawing for safety switch CTM... on page 36*).
- › Observe the maximum permissible angle between switch and actuator (max. 5°).
- › Fasten the actuator using non-removable safety screws.
- › Observe the tightening torque for mounting the switch and the actuator (max. 2.9 Nm).
- › The rear side of the switch and the actuator's plate must lie fully on the mounting surface.
- › When installing the switch in a concealed position, bear in mind that the active face of the read head must be kept clear (see chapter 16.3. *Dimension drawing for safety switch CTM... on page 36*).
- › Actuator and safety switch must be mounted such that the actuator is perpendicularly and completely inserted into the switch when the guard is closed. The guard locking function is not assured if mounting is incorrect.
- › The auxiliary release must be sealed before setup, e.g. with sealing lacquer.
- › The following applies to devices with connecting cable: In areas where high-pressure cleaners are used, ensure that the high-pressure cleaner jet does not act directly on the connecting cable or the cable entry into the device. Potential damage due to the high-pressure cleaner can result in the degree of protection IP69K no longer being achieved.
- › When mounting several safety switches, observe the stipulated minimum distance to avoid mutual interference.

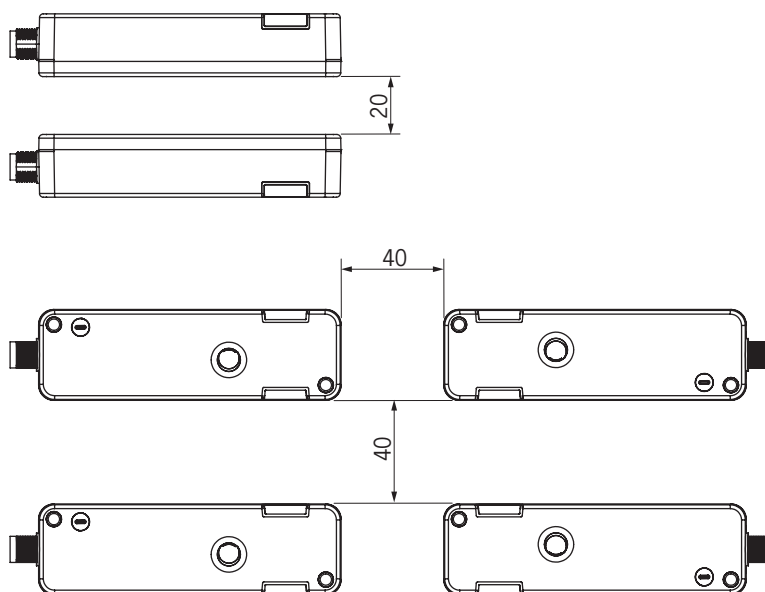

9. Electrical connection

The following connection options are available:

- › Separate operation
- › Series connection with wiring in the control cabinet
- › Series connection with Y-distributors
- › Connection without IO-Link communication
- › Connection with IO-Link communication



WARNING

In the event of a fault, loss of the safety function due to incorrect connection.

- › To ensure safety, both safety outputs must always be evaluated.
- › Monitoring outputs must not be used as safety outputs.
- › Lay the connecting cables with protection to prevent short circuits.



CAUTION

Risk of damage to equipment or malfunctions as a result of incorrect connection.

- › Do not use a control system with pulsing or switch off the pulsing function in your control system. The device generates its own test pulses on the safety outputs. A downstream control system must tolerate these test pulses, which may have a length of up to 300 μ s. Depending on the inertia of the downstream device (control system, relay, etc.), this can lead to short switching processes. The test pulses are output with the safety outputs switched off only during device start.
- › The inputs on a connected evaluation unit must be positive switching, as the two outputs on the safety switch deliver a level of +24 V in the switched-on state.
- › All the electrical connections must either be isolated from the mains supply by a safety transformer according to IEC 61558-2-6 with limited output voltage in the event of a fault, or by other equivalent insulation measures (SELV/PELV).
- › All electrical outputs must have an adequate protective circuit for inductive loads. The outputs must be protected with a free-wheeling diode for this purpose. Varistors and RC interference suppression units must not be used.
- › Power devices which are a powerful source of interference must be installed in a separate location away from the input and output circuits for signal processing. The cable routing for safety circuits should be as far away as possible from the cables of the power circuits.
- › To avoid EMC interference, the physical environmental and operating conditions at the installation site of the device must comply with the requirements according to the standard EN 60204-1 (EMC).
- › Pay attention to any interference fields from devices such as frequency converters or induction heating systems. Observe the EMC instructions in the manuals from the respective manufacturer.



Important!

If the device does not appear to function when the operating voltage is applied (e.g. the green STATE LED does not flash), the safety switch must be returned to EUCHNER.

9.1. Notes about



Important!

- › This device is intended to be used with a Class 2 power source in accordance with UL1310. As an alternative an LV/C (Limited Voltage/Current) power source with the following properties can be used:
This device shall be used with a suitable isolating source in conjunction with a fuse in accordance with UL248. The fuse shall be rated max. 3.3 A and be installed in the max. 30 V DC power supply to the device in order to limit the available current to comply with the UL requirements. Please note possibly lower connection ratings for your device (refer to the technical data).
- › For use and application as per the requirements of UL ¹⁾ a connecting cable listed under the UL category code CYJV/7, min. 24 AWG, min. 80 °C, must be used.

1) Note on the scope of the UL approval: The devices have been tested as per the requirements of UL508 and CSA/C22.2 no. 14 (protection against electric shock and fire).

9.2. Safety in case of faults

- › The operating voltage at UB and the solenoid operating voltage at IMP are reverse polarity protected.
- › The safety outputs FO1A/FO1B are short circuit-proof.
- › A short circuit between the safety outputs is detected on starting or when the safety outputs are activated by the device.
- › A short circuit in the cable can be excluded by laying the cable with protection.

9.3. Fuse protection for power supply

The power supply must be provided with fuse protection depending on the number of switches and the current required for the outputs. The following rules apply:

Max. current consumption of an individual switch I_{max}

$$I_{max} = I_{UB} + I_{FO1A+FO1B} + I_{OX} + I_{IMP}$$

$$I_{UB} = \text{Switch operating current (max. 500 mA)}$$

$$I_{OX} = \text{Load current of monitoring outputs (max. 50 mA per monitoring output)}$$

$$I_{FO1A+FO1B} = \text{Load current of safety outputs FO1A + FO1B (2 x max. 150 mA)}$$

$$I_{IMP} = \text{Switching current of solenoid control input (max. 50 mA)}$$



Important!

If there are further monitoring outputs, their load current must also be taken into account.

Max. current consumption of a switch chain ΣI_{max}

$$\Sigma I_{max} = I_{FO1A+FO1B} + n \times (I_{UB} + I_{OX} + I_{IMP})$$

$$n = \text{Number of connected switches}$$

9.4. Requirements for connecting cables



CAUTION

Risk of damage to equipment or malfunctions as a result of incorrect connecting cables.

- › Use connection components and connecting cables from EUCHNER.
- › If other connection components are used, the requirements in the following table apply. EUCHNER provides no warranty for safe function in case of failure to comply with these requirements.

Observe the following requirements with respect to the connecting cables:

| Parameter | Value | | Unit |
|-------------------------|---------------|----------------|-----------------|
| | M12/8-pin | M12/12-pin | |
| Recommended cable type | LIYY 8 x 0.34 | LIYY 12 x 0.25 | mm ² |
| Cable | 8 x 0.34 | 12 x 0.25 | mm ² |
| Cable resistance R max. | 80 | 80 | Ω/km |
| Inductance L max. | 0.65 | 0.65 | mH/km |
| Capacitance C max. | 120 | 120 | nF/km |

9.5. Connector assignments

9.5.1. Connector assignment of safety switch CTM-...-BP-...-SA-166089/166090 with plug connector M12, 8-pin

| Plug connector (view of connection side) | Pin | Designation | Function | Conductor coloring of connecting cable ¹⁾ |
|---|-----|-------------|---|--|
| 1 x M12 | 1 | IMP | Solenoid control input, 24 V DC | WH |
| | 2 | UB | Electronics and solenoid operating voltage, 24 V DC | BN |
| | 3 | F01A | Safety output, channel A | GN |
| | 4 | F01B | Safety output, channel B | YE |
| | 5 | OI | Diagnostic monitoring output | GY |
| | 6 | OD/C | Door position monitoring output/communication | PK |
| | 7 | OL | Guard lock monitoring output | BU |
| | 8 | OVUB | Electronics and solenoid operating voltage, 0 V DC | RD |



1) Only for standard EUCHNER connecting cable

9.5.2. Connector assignment of safety switch CTM-...-BP-...-SA-166087/166088 with plug connector M12, 8-pin

| Plug connector (view of connection side) | Pin | Designation | Function | Conductor coloring of connecting cable ¹⁾ |
|---|-----|-------------|---|--|
| 1 x M12 | 1 | IMP | Solenoid control input, 24 V DC | WH |
| | 2 | UB | Electronics and solenoid operating voltage, 24 V DC | BN |
| | 3 | F01A | Safety output, channel A | GN |
| | 4 | F01B | Safety output, channel B | YE |
| | 5 | OI | Diagnostic monitoring output | GY |
| | 6 | OD/C | Door position monitoring output/communication | PK |
| | 7 | OVUB | Electronics and solenoid operating voltage, 0 V DC | BU |
| | 8 | IMM | Solenoid control input, 0 V DC | RD |

1) Only for standard EUCHNER connecting cable

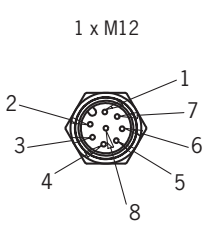



9.5.3. Connector assignment/terminal assignment of safety switches CTM-...-BR-...-SA-... with plug connector M12, 8-pin CTM-...-BR-...-V05-... with connecting cable, 8-core

| Plug connector (view of connection side) | Pin | Designation | Function | Conductor coloring of connecting cable ¹⁾ |
|--|-----|--------------------|--|--|
|  <p>1 x M12</p> | 1 | F11B | Enable input, channel B | WH |
| | 2 | UB | Electronics and solenoid operating voltage, 24 V DC | BN |
| | 3 | F01A | Safety output, channel A  | GN |
| | 4 | F01B | Safety output, channel B  | YE |
| | 5 | Ox/C ²⁾ | Door position or guard lock monitoring output/communication | GY |
| | 6 | F11A | Enable input, channel A | PK |
| | 7 | OVUB | Electronics and solenoid operating voltage, 0 V DC | BU |
| | 8 | IMP | Solenoid control input, 24 V DC | RD |

1) Only for standard EUCHNER connecting cable

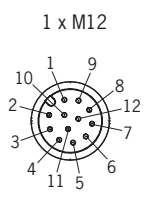
2) Monitoring output Ox can assume the function OD (door position) or OL (guard locking). More detailed information about your device is available at www.euchner.com. Simply enter the order number.

9.5.4. Connector assignment of safety switch CTM-...-BR-...-SP-... with plug connector M12, 12-pin

| Plug connector (view of connection side) | Pin | Designation | Function |
|--|-----|-------------|--|
|  <p>1 x M12</p> | 1 | UB | Electronics and solenoid operating voltage, 24 V DC |
| | 2 | F11A | Enable input, channel A |
| | 3 | OVUB | Electronics and solenoid operating voltage, 0 V DC |
| | 4 | F01A | Safety output, channel A  |
| | 5 | OD/C | Door position monitoring output/communication |
| | 6 | F11B | Enable input, channel B  |
| | 7 | F01B | Safety output, channel B  |
| | 8 | RST | Reset input |
| | 9 | OL | Guard lock monitoring output |
| | 10 | IMP | Solenoid control input, 24 V DC |
| | 11 | OI | Diagnostic monitoring output |
| | 12 | IMM | Solenoid control input, 0 V DC |

9.6. Notes on operation with safe control systems

Observe the following guidelines for connection to safe control systems:

- › Use a common power supply for the control system and the connected safety switches.
- › A pulsed power supply must not be used for UB. Tap the supply voltage directly from the power supply unit. If the power supply is connected to a terminal of a safe control system, this output must provide sufficient electrical current.
- › The safety outputs F01A and F01B can be connected to the safe inputs of a control system. Prerequisite: the input must be suitable for pulsed safety signals (OSSD signals, e.g. from light grids). The control system must tolerate test pulses on the input signals. This normally can be set up by parameter assignment in the control system. Observe the notes of the control system manufacturer. For the test pulse duration of your safety switch, refer to chapter 16. *Technical data on page 33.*
- › With series connection: always connect inputs F11A and F11B directly to a power supply unit or to outputs F01A and F01B of another EUCHNER BR device. Pulsed signals must not be present at inputs F11A and F11B.

A detailed example of connecting and setting the parameters of the control system is available for many devices at www.euchner.com, in the area *Downloads/Applications/CTM*. The features of the respective device are dealt with there in greater detail.

9.7. Connection without and with IO-Link communication

9.7.1. Connection without IO-Link communication

Only the safety and monitoring outputs are switched with this connection method.

With a series connection, the safety signals are looped through from device to device.

9.7.2. Connection with IO-Link communication

If, in addition to the safety function, detailed monitoring and diagnostic data are to be processed, a BR/IO-Link Gateway is required. To poll the communication data from the connected device, communication connection C is routed to the BR/IO-Link Gateway.

You will find further information in the operating instructions for your BR/IO-Link Gateway.

10. Connection of a single CTM-BP/BR (separate operation)



WARNING

In the event of a fault, loss of the safety function due to incorrect connection.
 ▶ To ensure safety, both safety outputs FO1A and FO1B must always be evaluated.



Important!

The example shows only an excerpt that is relevant for connection of the CTM system. The example illustrated here does not show complete system planning. The user is responsible for safe integration into the overall system. Detailed application examples can be found at www.euchner.com. Simply enter the order number of your switch in the search box. You will find all available connection examples for the device in *Downloads*.

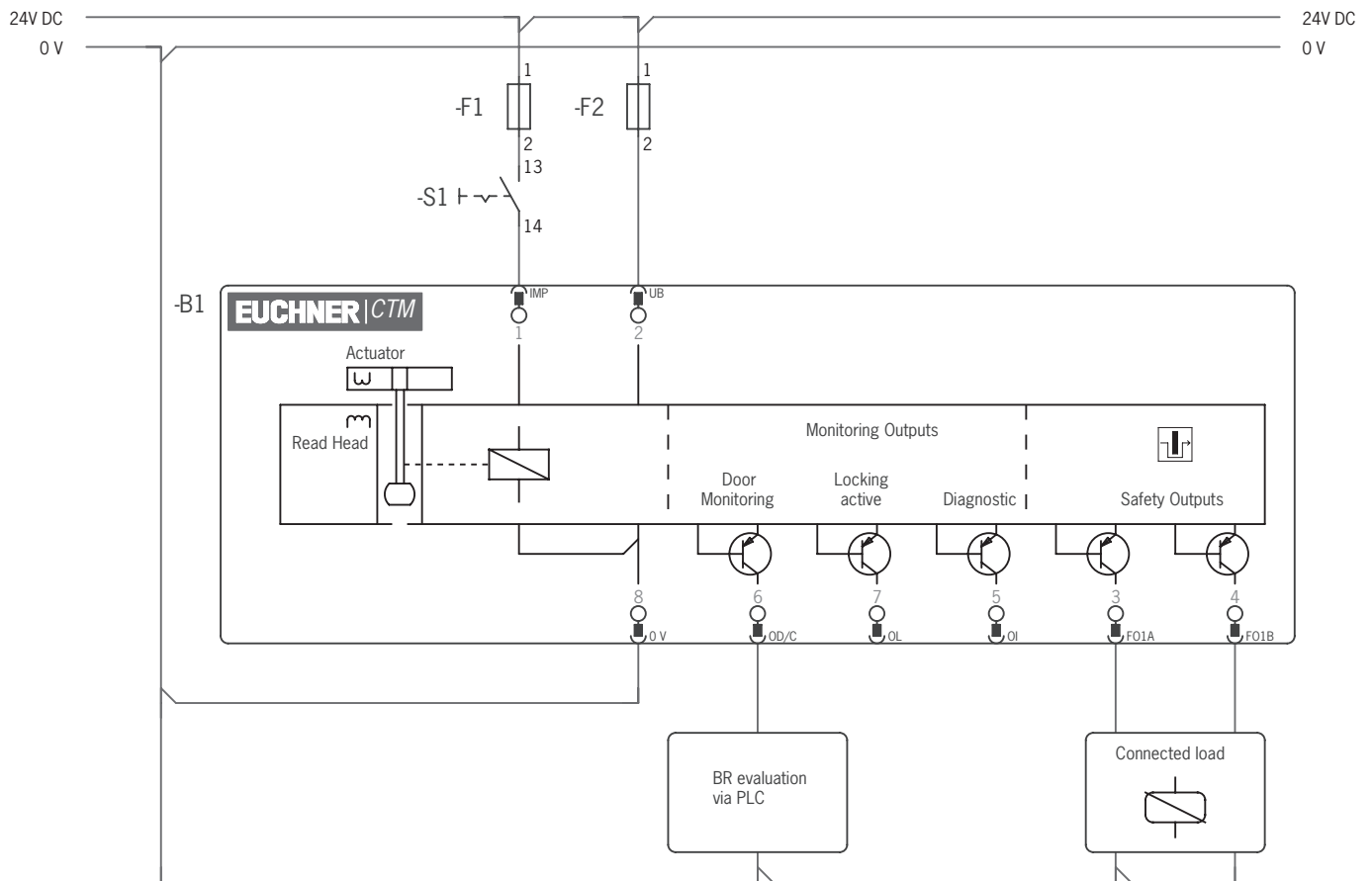

Fig. 1: Connection example without control input IMM (principle of operation)

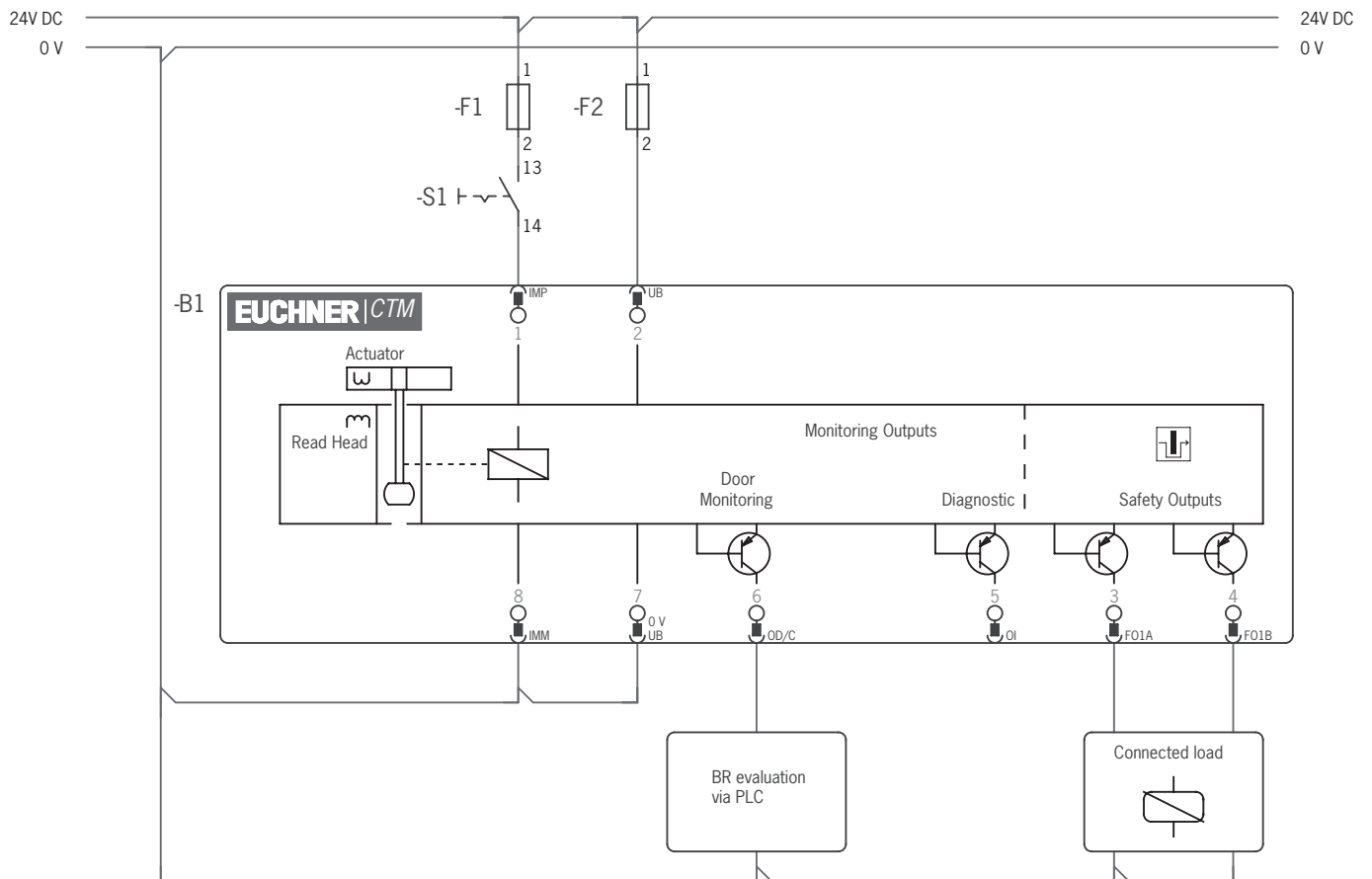

Fig. 2: Connection example with control input IMM (principle of operation)

11. Connection of several devices in a chain (series connection)



WARNING

In the event of a fault, loss of the safety function due to incorrect connection.
 › To ensure safety, both safety outputs FO1A and FO1B must always be evaluated.



Important!

› A BR chain may contain a maximum of 20 devices.
 › The example shows only an excerpt that is relevant for connection of the CTM system. The example illustrated here does not show complete system planning. The user is responsible for safe integration into the overall system. Detailed application examples can be found at www.euchner.com. Simply enter the order number of your switch in the search box. You will find all available connection examples for the device in *Downloads*.
 › Make sure you use the correct Y-distributors. See chapter 11.2.3. *Connector assignment of Y-distributor for series connection without O-Link communication on page 23*.

11.1. Series connection with wiring in the control cabinet

The series connection can be implemented via additional terminals in a control cabinet.



Important!

In case of series connection with IO-Link communication:
 › The safety outputs are permanently assigned to the respective safety inputs of the downstream switch. FO1A must be routed to FI1A and FO1B to FI1B.
 › If the connections are interchanged (e.g. FO1A to FI1B), the downstream device will enter the fault state.

11.2. Series connection with Y-distributors

The series connection is shown here based on the example of the version with plug connector M12. The switches are connected one behind the other with the aid of pre-assembled connecting cables and Y-distributors. If a safety door is opened or if a fault occurs on one of the switches, the system shuts down the machine.

11.2.1. Maximum cable lengths with BR switch chains



Important!

The maximum number of switches in a BR switch chain depends on many factors, including the cable length. This case example shows a standard application. You will find further connection examples at www.euchner.com.

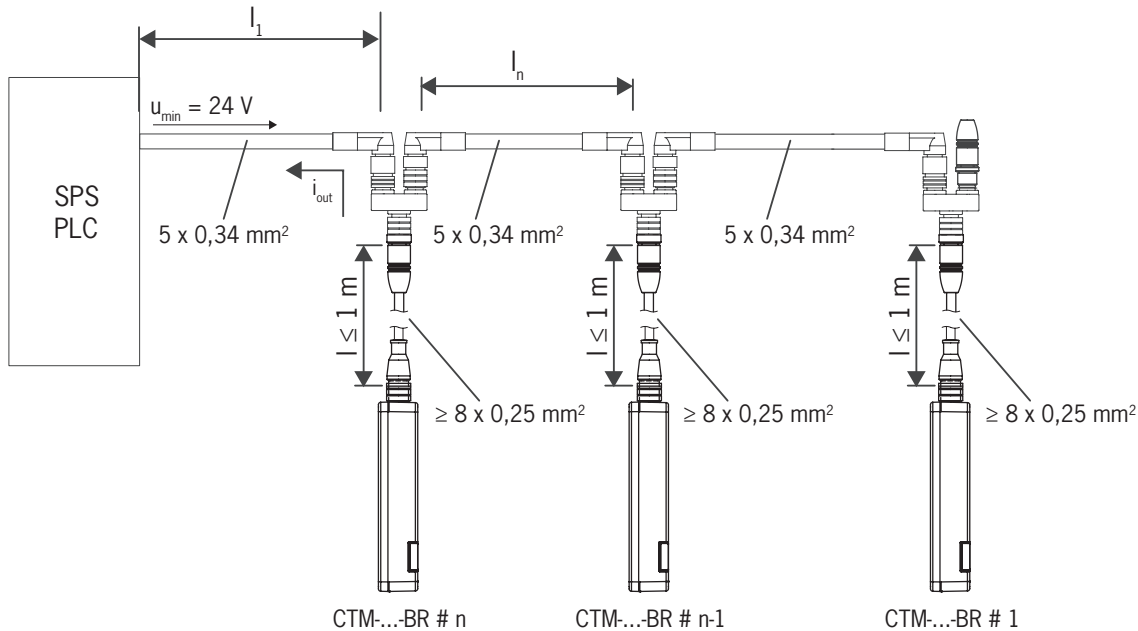

11.2.2. Determining cable lengths

| n Max. number of switches depending on the cable length | I _{F01A/F01B} (mA) Possible output current per channel F01A/F01B | l ₁ (m) Max. cable length from the last switch to the control system 0.34 mm ² | l _n (m) Max. cable length between the individual switches |
|--|--|---|---|
| 1 | 10 | 140 | - |
| | 25 | 130 | |
| | 50 | 115 | |
| | 100 | 100 | |
| | 150 | 85 | |
| 2 | 10 | 50 | 10 |
| | 25 | | |
| | 50 | | |
| | 100 | | |
| | 150 | | |
| 3 | 10 | 25 | 10 |
| | 25 | | |
| | 50 | | |
| | 100 | | |
| | 150 | | |

Contact EUCHNER in the following cases:

- › If you connect more than 3 switches in series.
- › If you plan to use a different cable design (cross-section, material, etc.)

11.2.3. Connector assignment of Y-distributor for series connection without O-Link communication



Important!

- The switch chain must always be terminated with strapping plug 097645.
- All guard locking solenoids are always controlled simultaneously on the use of these Y-distributors in a series connection.
- A higher-level control system cannot detect which safety door is open or on which switch a fault has occurred with this connection technology.

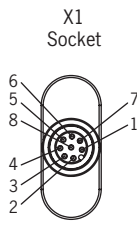
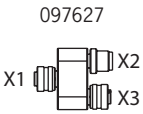
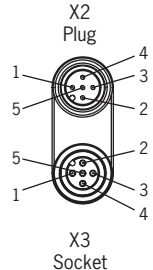
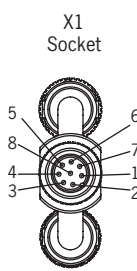
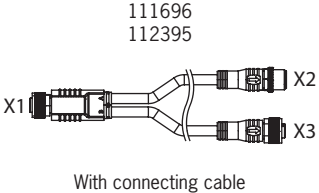
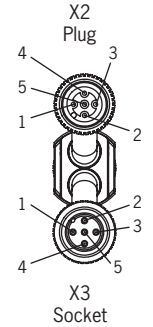
| Plug connector X1 | | Y-distributor | Plug connector X2 / X3 | | | | | | | | | | | | | | | | | | | | | | | | | | | | | | | | | | |
|---|----------|---|---|-----|----------|------|----------|------|----|------|------|------|------|------|------|------|------|------|------|------|---|---|--|----|--|-----|----------|------|----|------|------|------|-----|------|------|------|---|
| <table border="1"> <thead> <tr> <th colspan="2">X1</th> </tr> <tr> <th>Pin</th> <th>Function</th> </tr> </thead> <tbody> <tr><td>X1.1</td><td>FI1B</td></tr> <tr><td>X1.2</td><td>UB</td></tr> <tr><td>X1.3</td><td>F01A</td></tr> <tr><td>X1.4</td><td>F01B</td></tr> <tr><td>X1.5</td><td>n.c.</td></tr> <tr><td>X1.6</td><td>FI1A</td></tr> <tr><td>X1.7</td><td>OVUB</td></tr> <tr><td>X1.8</td><td>*</td></tr> </tbody> </table>  | | X1 | | Pin | Function | X1.1 | FI1B | X1.2 | UB | X1.3 | F01A | X1.4 | F01B | X1.5 | n.c. | X1.6 | FI1A | X1.7 | OVUB | X1.8 | * |  <p>097627</p> |  <table border="1"> <thead> <tr> <th colspan="2">X2</th> </tr> <tr> <th>Pin</th> <th>Function</th> </tr> </thead> <tbody> <tr><td>X2.1</td><td>UB</td></tr> <tr><td>X2.2</td><td>F01A</td></tr> <tr><td>X2.3</td><td>0 V</td></tr> <tr><td>X2.4</td><td>F01B</td></tr> <tr><td>X2.5</td><td>*</td></tr> </tbody> </table> | X2 | | Pin | Function | X2.1 | UB | X2.2 | F01A | X2.3 | 0 V | X2.4 | F01B | X2.5 | * |
| X1 | | | | | | | | | | | | | | | | | | | | | | | | | | | | | | | | | | | | | |
| Pin | Function | | | | | | | | | | | | | | | | | | | | | | | | | | | | | | | | | | | | |
| X1.1 | FI1B | | | | | | | | | | | | | | | | | | | | | | | | | | | | | | | | | | | | |
| X1.2 | UB | | | | | | | | | | | | | | | | | | | | | | | | | | | | | | | | | | | | |
| X1.3 | F01A | | | | | | | | | | | | | | | | | | | | | | | | | | | | | | | | | | | | |
| X1.4 | F01B | | | | | | | | | | | | | | | | | | | | | | | | | | | | | | | | | | | | |
| X1.5 | n.c. | | | | | | | | | | | | | | | | | | | | | | | | | | | | | | | | | | | | |
| X1.6 | FI1A | | | | | | | | | | | | | | | | | | | | | | | | | | | | | | | | | | | | |
| X1.7 | OVUB | | | | | | | | | | | | | | | | | | | | | | | | | | | | | | | | | | | | |
| X1.8 | * | | | | | | | | | | | | | | | | | | | | | | | | | | | | | | | | | | | | |
| X2 | | | | | | | | | | | | | | | | | | | | | | | | | | | | | | | | | | | | | |
| Pin | Function | | | | | | | | | | | | | | | | | | | | | | | | | | | | | | | | | | | | |
| X2.1 | UB | | | | | | | | | | | | | | | | | | | | | | | | | | | | | | | | | | | | |
| X2.2 | F01A | | | | | | | | | | | | | | | | | | | | | | | | | | | | | | | | | | | | |
| X2.3 | 0 V | | | | | | | | | | | | | | | | | | | | | | | | | | | | | | | | | | | | |
| X2.4 | F01B | | | | | | | | | | | | | | | | | | | | | | | | | | | | | | | | | | | | |
| X2.5 | * | | | | | | | | | | | | | | | | | | | | | | | | | | | | | | | | | | | | |
|  | |  <p>111696 112395</p> <p>With connecting cable</p> |  <table border="1"> <thead> <tr> <th colspan="2">X3</th> </tr> <tr> <th>Pin</th> <th>Function</th> </tr> </thead> <tbody> <tr><td>X3.1</td><td>UB</td></tr> <tr><td>X3.2</td><td>FI1A</td></tr> <tr><td>X3.3</td><td>0 V</td></tr> <tr><td>X3.4</td><td>FI1B</td></tr> <tr><td>X3.5</td><td>*</td></tr> </tbody> </table> | X3 | | Pin | Function | X3.1 | UB | X3.2 | FI1A | X3.3 | 0 V | X3.4 | FI1B | X3.5 | * | | | | | | | | | | | | | | | | | | | | |
| X3 | | | | | | | | | | | | | | | | | | | | | | | | | | | | | | | | | | | | | |
| Pin | Function | | | | | | | | | | | | | | | | | | | | | | | | | | | | | | | | | | | | |
| X3.1 | UB | | | | | | | | | | | | | | | | | | | | | | | | | | | | | | | | | | | | |
| X3.2 | FI1A | | | | | | | | | | | | | | | | | | | | | | | | | | | | | | | | | | | | |
| X3.3 | 0 V | | | | | | | | | | | | | | | | | | | | | | | | | | | | | | | | | | | | |
| X3.4 | FI1B | | | | | | | | | | | | | | | | | | | | | | | | | | | | | | | | | | | | |
| X3.5 | * | | | | | | | | | | | | | | | | | | | | | | | | | | | | | | | | | | | | |

* Function and compatibility are dependent on the connector assignment of the device connected.

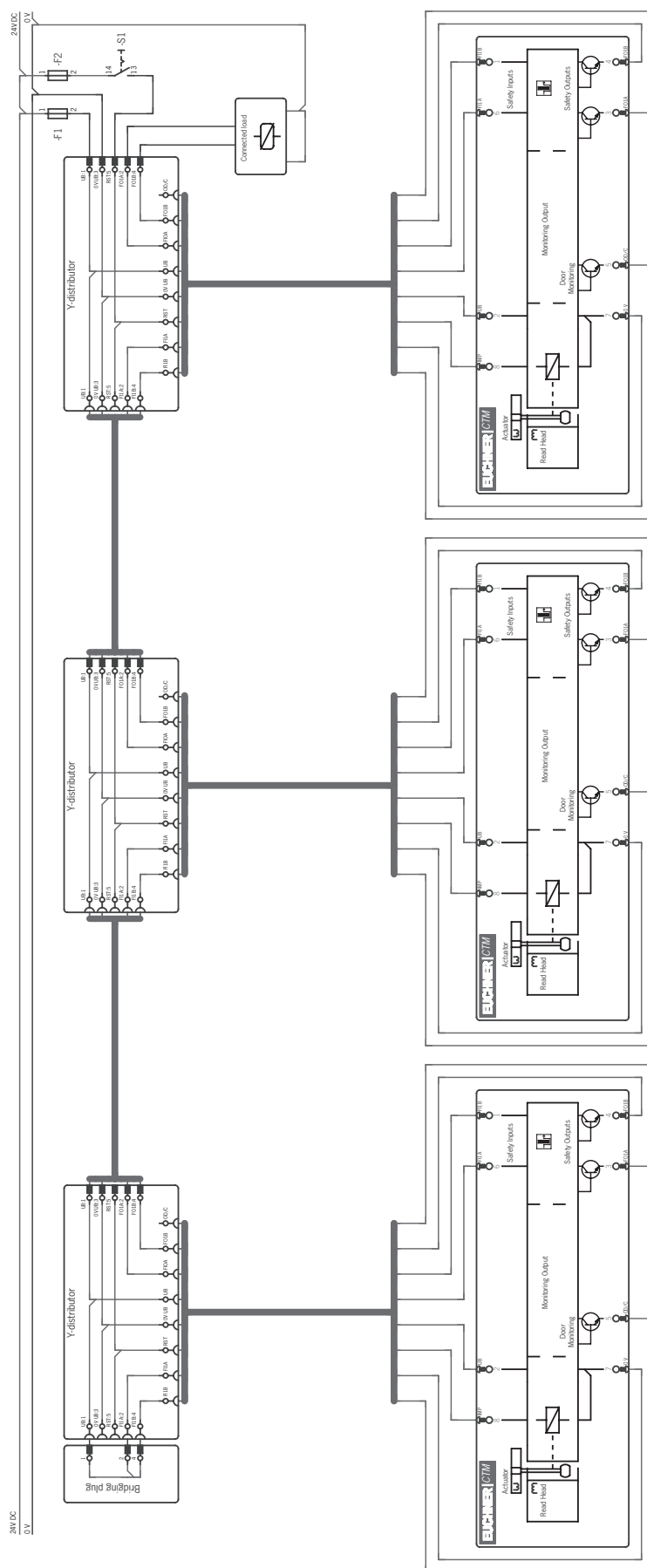

Fig. 3: Connection example for series connection with control of guard locking via control input IMP (principle of operation)

12. Using communication data

A BR/IO-Link Gateway is required to use the device's communication data and forward them to a higher-level bus system. The following devices are suitable:

- › GWY-CB-1-BR-IO (BR/IO-Link Gateway)
- › ESM-CB (safety relay with integrated BR/IO-Link Gateway)

12.1. Connection to a BR/IO-Link Gateway GWY-CB

The Gateway is an IO-Link device. Communication via IO-Link offers cyclical (process data) and acyclical (device data and events) data exchange (see chapter 12.3. *Overview of the communication data on page 25*).

The communication connection C on the device allows the diagnostic line to be connected to the Gateway. The Ox/C connection represents a non-safety-related communication channel between the Gateway and the connected devices.

IO-Link communication can be used for the following functions as well:

- › Reset for acknowledging error messages

You will find further information in the operating instructions for your BR/IO-Link Gateway.

12.2. Connection to a safety relay ESM-CB

The safety relay ESM-CB features an integrated BR/IO-Link Gateway. In addition to functioning as an IO-Link device (see chapter 12.1. *Connection to a BR/IO-Link Gateway GWY-CB on page 25*), the device can be used for connecting two monitored single- or dual-channel sensor circuits. The sensor circuits evaluate various signaling devices:

- › Sensor circuit S1 with short circuit detection; suitable for single- or dual-channel safety sensors
- › Sensor circuit S2, suitable for OSSD signals; short circuit detection by signaling device

When at least one sensor circuit is interrupted, the safety relay initiates the safe state. Different relay starting behaviors and various monitoring functions are possible.

The device's safety outputs FO1A and FO1B are routed to the OSSD inputs of the safety relay. The OD/C connection of the device allows the diagnostic line to be connected to the Gateway.

You will find further information in the operating instructions for your safety relay with integrated BR/IO-Link Gateway.

12.3. Overview of the communication data

The switch transmits both process data that are continuously transmitted to the evaluation unit (cyclical data) and data that can be polled specifically as needed (acyclical data). For further information on connection and on the communication data, refer to the operating instructions for your BR/IO-Link Gateway.

12.3.1. Cyclical data (process data)

Table 2: Cyclical data (process data)

| | Bit 7 | Bit 6 | Bit 5 | Bit 4 | Bit 3 | Bit 2 | Bit 1 | Bit 0 |
|--------|-------|-------|-------|-------|-------|-------|-------|-------|
| Byte 1 | OI | - | - | - | OM | - | - | OD |
| Byte 2 | - | - | - | - | OLS | - | OL | - |

| Bit | Signal | Message |
|-----|-----------------|--|
| OI | Diagnostics | There is a fault, see chapter 15.3. <i>Error messages on page 31</i> . |
| OM | Status | The safety outputs of the device are switched. |
| OD | Door position | A valid actuator is detected in the actuating range, and the guard is closed. |
| OLS | Locking element | The locking element is stuck, see chapter 15.3. <i>Error messages on page 31</i> . |
| OL | Guard locking | Guard locking is active. |

12.3.2. Acyclical data (device data and events)

After one of the commands listed below is sent, the requested data are provided via the IO-Link Gateway. The reply message always consists of 8 bytes in big endian format.

Example: reply message in response to the command *Send device ID number/serial number*: 06 **02 77 67 00 01 17 00**

In this example, the device's ID number is **161639** and its serial number is **279**.

| Byte number | Byte 0 | Byte 1 | Byte 2 | Byte 3 | Byte 4 | Byte 5 | Byte 6 | Byte 7 |
|--------------|---------------------------|------------------|-----------|-----------|---------------|-----------|-----------|--------------|
| Reply in hex | 06 | 02 | 77 | 67 | 00 | 01 | 17 | 00 |
| Description | User data length in bytes | Device ID number | | | Serial number | | | Padding data |
| Reply in dec | 6 bytes | 161639 | | | 279 | | | - |

| Command | | Reply | | |
|---------|--|-----------------|-----------------------------------|---|
| HEX | Meaning | Number of bytes | Bit sequences (big endian format) | |
| 0x02 | Send device ID number/serial number | 6 | Bytes 1 - 3 | Device ID number |
| | | | Bytes 4 - 6 | Serial number |
| 0x03 | Send version number of the device | 5 | Byte 1 | {V} |
| | | | Bytes 2 - 4 | Version number |
| 0x05 | Send number of devices in series connection | 1 | | |
| 0x12 | Send current error code | 1 | | |
| 0x13 | Send most recently saved error code | 1 | | |
| 0x14 | Send size of log file | 1 | | |
| 0x15 | Send entry from log file with index | 1 | | |
| 0x16 | Send current actuator code | 5 | | |
| 0x17 | Send taught-in actuator code | 5 | | |
| 0x18 | Send disabled actuator code | 5 | | |
| 0x19 | Send applied voltage in mV | 2 | | |
| 0x0F | Send number of teach-in operations, factory resets and resets for acknowledging error messages | 3 | Byte 1 | Number of teach-in operations |
| | | | Byte 2 | Number of factory resets |
| | | | Byte 3 | Number of resets for acknowledging error messages |
| 0x1A | Send current temperature in °C | 1 | | |
| 0x1B | Send number of door position switching cycles | 3 | | |
| 0x1D | Reset for acknowledging error messages ¹⁾ | - | | |
| 0x1E | Factory reset | 1 | 0x1E – Factory reset performed | |

1) Each BR device must be addressed individually in a chain.

For more information on these and other acyclical data, refer to the operating instructions for your BR/IO-Link Gateway.

13. Setup

13.1. Teaching-in actuator (only for unicode evaluation)

The actuator must be allocated to the safety switch using a teach-in function before the system forms a functional unit.

During a teach-in operation, the safety outputs are switched off, i.e. the system is in the safe state.

The teach-in operation starts automatically after the operating voltage is switched on. The number of possible teach-in operations is unlimited.



Tip!

Prior to switching on, close the guard on which the actuator to be taught-in is installed. The teach-in operation starts immediately after switching on. This feature simplifies above all teach-in with series connections and on large installations.



Important!

- › The teach-in operation can be performed only if the device does not have any internal fault.
- › Devices in the condition as supplied remain in teach-in standby state until they have successfully taught-in the first actuator. Once taught-in, switches remain in the teach-in standby state for approx. 3 min. after each switch-on.
- › The safety switch disables the code of the preceding device if teach-in is carried out for a new actuator. Teach-in is not possible again immediately for this device if a new teach-in operation is carried out. The disabled code is enabled again in the safety switch only after a third code has been taught-in.
- › The safety switch can be operated only with the last actuator taught-in.
- › If the switch detects the actuator that was most recently taught-in when in the teach-in standby state, this state is ended immediately and the switch changes to normal operation.
- › The actuator to be taught-in is not activated if it is within the actuating range for less than 30 s.

1. Establish teach-in standby:

- Devices in the condition as supplied: unlimited teach-in standby after switching on.
- Switch already taught-in: teach-in standby is available for approx. 3 min after switching on.

➔ Teach-in standby indication, STATE LED flashes 3x repeatedly.

2. Insert the actuator during teach-in standby.

➔ The automatic teach-in operation starts (duration approx. 30 s).

The STATE LED flashes slowly during the teach-in operation.

Alternate flashing of the STATE and DIA LEDs acknowledges the successful teach-in operation.

Teach-in errors are indicated by the illumination of the red DIA LED and a flashing code of the green STATE LED (see chapter 15.2. Status messages on page 30).

3. Switch off operating voltage (min. 3 s).

➔ The code of the actuator that was just taught-in is activated in the safety switch.

4. Switch on operating voltage.

➔ The device operates normally.

13.2. Functional check



WARNING

Danger of fatal injury as a result of faults in installation and the functional check.

- › Before carrying out the functional check, make sure that there are no persons in the danger area.
- › Observe the valid accident prevention regulations.

13.2.1. Mechanical function test

The actuator must slide easily into the switch. Close the guard several times to check the function.

13.2.2. Electrical function test

After installation and after any fault, the safety function must be fully checked. Proceed as follows:

1. Switch on operating voltage.
 - ➔ The machine must not start automatically.
 - ➔ The safety switch carries out a self-test. The green STATE LED flashes for 5 s at 5 Hz. The green STATE LED then flashes at regular intervals.
2. Close all guards. In case of guard locking by solenoid force: activate guard locking.
 - ➔ The machine must not start automatically. It must not be possible to open the guard.
 - ➔ The green STATE LED and the yellow LOCK LED are illuminated continuously.
3. Enable operation in the control system.
 - ➔ It must not be possible to deactivate guard locking as long as operation is enabled.
4. Disable operation in the control system and deactivate guard locking.
 - ➔ The guard must remain locked until there is no longer any risk of injury.
 - ➔ It must not be possible to start the machine as long as guard locking is deactivated.

Repeat steps 2 - 4 for each guard.

14. Factory reset

A factory reset deletes the configuration and restores the device's factory settings.

To perform a factory reset, connect the two outputs F01A and F01B to 0 V before connecting the operating voltage or send the command 0x1E via IO-Link communication (see chapter 12.3.2. *Acyclical data (device data and events)* on page 26).

15. Status and error messages

15.1. LED displays

| LED | Color |
|-------|--------|
| STATE | green |
| LOCK | yellow |
| DIA | red |

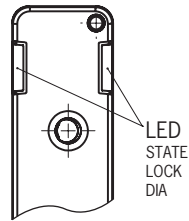

















Important!



















If you do not find the displayed device status in the following tables, this indicates an internal device fault. Contact EUCHNER.

| Key to symbols | ○ | | LED not illuminated |
|----------------|----------------|--|---------------------------------------|
| | | | LED illuminated |
| | 1 x inverse | | LED illuminated, briefly goes off 1 x |
| | quickly | | LED flashes quickly (3 Hz) |
| | slowly | | LED flashes slowly (0.6 Hz) |
| | 3 x | | LED repeatedly flashes three times |
| | | | LEDs flash alternately |
| | X | | Any state |

15.2. Status messages

| Operating mode | LED indicator | | | Safety outputs F01A/F01B  | Guard locking signal OL | Door position signal OD | Status |
|--------------------|--|---|--|---|---|-------------------------|--|
| | STATE green | LOCK yellow | DIA red | | | | |
| Self-test |  5 Hz (5 s) | ○ | ○ | off | off | off | Self-test after operating voltage is switched on. |
| |  quickly | |  1 x | | | | No communication with the BR/IO-Link Gateway. |
| Normal operation |  |  | ○ | on | on | on | Door is closed and locked. The safety outputs of the preceding device in a series connection are switched on. |
| |  1 x inverse | ○ | | off | off | on | Door is closed and not locked. The safety outputs of the preceding device in a series connection are switched off. |
| |  1 x | | | off | off | off | Door is open. |
| |  1 x | | |  1 x | off | off | off |
| Teach-in operation |  3 x | ○ | ○ | off | off | X | Device is in teach-in standby (see chapter 13.1. <i>Teaching-in actuator (only for unicode evaluation) on page 27</i>). |
| |  slowly | | | | X | on | Teach-in operation. Door is closed. |
| |  | | | |  | X | X |
| Error |  | depending on the error |  or  1x inverse | off | depending on the error | | Error message (see chapter 15.3. <i>Error messages on page 31</i>). |

15.3. Error messages

| Error code via IO-Link | LED indicator | | | Error | Troubleshooting | Ac-knowledging errors | | |
|--------------------------------|---|---|---|--|--|--|-------|---|
| | STATE green | LOCK yellow | DIA red | | | Opening/closing door | Reset | |
| Teach-in errors | | | | | | | | |
| 0x1F | | | | Actuator removed from the actuating range prior to the end of the teach-in operation. | Check whether the actuator is outside the actuating range or in the limit range. | | ● | |
| 0x25 |  |  |  | Disabled actuator detected during the teach-in operation: The actuator was taught-in during the penultimate teach-in operation and is disabled for the current teach-in operation. | Repeat the teach-in operation with a new actuator (see chapter 13.1. <i>Teaching-in actuator (only for unicode evaluation) on page 27</i>). | | ● | |
| Input errors | | | | | | | | |
| 0x2E | | | | Different signal states at the safety inputs F1A and F1B during operation. | | ● | | |
| 0x30 |  |  |  | Different signal states at the safety inputs F1A and F1B during the self-test. | <ul style="list-style-type: none"> › Check wiring. › Check preceding device in the switch chain. | | ● | |
| 0x31 0x32 | | | | Test pulses not detected at safety input F1A or F1B during operation. | | | | |
| 0x36 0x37 | | | | Test pulses not detected at safety input F1A or F1B during the self-test. | | | | |
| | | | | | | | | |
| Transponder/read errors | | | | | | | | |
| 0x42 |  |  |  | Invalid or faulty actuator detected during teach-in operation. <ul style="list-style-type: none"> › The actuator is not intended for the current device configuration. › The actuator's data structure cannot be read. The actuator is defective. | Repeat the teach-in operation with a valid actuator (see chapter 13.1. <i>Teaching-in actuator (only for unicode evaluation) on page 27</i>). | | ● | |
| | | | | Invalid or faulty actuator detected. <ul style="list-style-type: none"> › The actuator is not intended for the current device configuration. › The actuator's data structure cannot be read. The actuator is defective. | Remove actuator. Error is reset automatically. | | | |
| Output errors | | | | | | | | |
| 0x4C 0x4D |  |  |  | A HIGH signal is detected at safety output FO1A or FO1B during the self-test. | Check wiring. | | ● | |
| 0x54 | | | | The voltage level at safety outputs FO1A and FO1B during operation does not meet the requirements. External voltage might be present. | | | | |
| Environment errors | | | | | | | | |
| 0x60 |  |  |  | Supply voltage too high. | Decrease supply voltage. | | ● | |
| 0x61 | | | | Supply voltage too low. | <ul style="list-style-type: none"> › Increase supply voltage. › Check system configuration: cable length, number of devices in the switch chain. | | ● | |
| 0x62 | | | |  | Device temperature too high. | Observe the specified temperature range (see chapter 16. <i>Technical data on page 33</i>). | | ● |
| 0x63 | | | | | Device temperature too low. | | | ● |
| Internal fault | | | | | | | | |
| 0x01 |  |  |  | Internal device fault | Restart the device. On repeated occurrence, contact EUCHNER. | | ● | |

| Error code via IO-Link | LED indicator | | | Error | Troubleshooting | Ac-knowledging errors | |
|----------------------------|---------------|-------------|---------|---|--|-----------------------|-------|
| | STATE green | LOCK yellow | DIA red | | | Opening/closing door | Reset |
| Plausibility errors | | | | | | | |
| 0x89 | | | | Transponder is no longer detected when guard locking is active. Actuator defective or malfunctioning. | Check actuator and replace it if necessary. | | ● |
| 0x8C | ○ | | | Guard locking was opened without active control: › Auxiliary release was actuated. › Internal fault | › Reset auxiliary release and restart the device. › On repeated occurrence, contact EUCHNER. | | ● |
| Other errors | | | | | | | |
| 0xAC | ○ | | | Guard locking cannot be activated. | Open door for at least 3 s. When closing the door again, ensure that the actuator is fully inserted. | | ● |

15.4. Acknowledging error messages

If the DIA LED flashes inversely once, the error message can be acknowledged by opening and closing the guard. If the error is still displayed afterward, a reset must be performed.

If the DIA LED is permanently illuminated, the error message can be acknowledged only by a reset.

The reset can be performed as follows.

| Reset | Centrally for all devices in a chain | Each device must be addressed individually | Further information |
|--|--------------------------------------|--|---|
| By briefly disconnecting the power supply (at least 3 s) | ● | - | - |
| Via the cyclical data of IO-Link communication | ● | - | See operating instructions for the IO-Link Gateway |
| Via the acyclical data of IO-Link communication | - | ● | See chapter 12.3.2. <i>Acyclical data (device data and events)</i> on page 26 |

Reset for acknowledging error messages does not delete the configuration.



Important!

Contact EUCHNER if the fault display is not reset after briefly disconnecting the power supply.

16. Technical data



NOTICE

If a data sheet is available for the product, the information on the data sheet applies.

16.1. Technical data for safety switch CTM-LBI

| Parameter | Value | | | Unit |
|--|---|------|----------------|-------|
| | min. | typ. | max. | |
| General | | | | |
| Material - Seals - Switch housing | Fluorinated rubber (FKM) Reinforced thermoplastic | | | |
| Installation position | Any | | | |
| Degree of protection | IP65/IP67/IP69/IP69K ¹⁾ (screwed tight with the related mating connector) | | | |
| Safety class acc. to EN IEC 61140 | III | | | |
| Degree of contamination (external, acc. to EN IEC 60947-1) | 3 (industrial) | | | |
| Mechanical life | 1 x 10 ⁶ operating cycles | | | |
| Ambient temperature at U _B = 24 V | -20 | - | +60 | °C |
| Actuator approach speed | - | - | 20 | m/min |
| Actuating/extraction/retention force | Device dependent, see www.euchner.com | | | N |
| Locking force F _{max} | 1,300 | | | N |
| Locking force F _{Zh} | F _{Zh} = F _{max} /1.3 = 1,000 | | | N |
| Weight | Approx. 0.16 | | | kg |
| Connection (depending on version) | 1 plug connector M12, 8-pin/1 plug connector M12, 12-pin/connecting cable with flying lead, 5 m, 8 x 0.25 mm ² | | | |
| Operating voltage U _B (reverse polarity protected, regulated, residual ripple < 5%) | 24 ±15% (PELV) | | | V DC |
| Current consumption I _{UB} at U _B = 24 V | - | 385 | 500 | mA |
| The following applies to the approval acc. to UL | Operation only with UL Class 2 power supply or equivalent measures | | | |
| Switching load acc. to UL | 24 V DC, class 2 | | | |
| External fuse (operating voltage U _B) | 0.7 | - | 8 | A |
| External fuse (guard locking solenoid control input U _{IMP}) | 0.1 | - | 2 | A |
| Rated insulation voltage U _i | 50 | | | V |
| Rated impulse withstand voltage U _{imp} | 0.5 | | | kV |
| Rated conditional short-circuit current | 100 | | | A |
| Shock and vibration resistance | Acc. to EN 60947-5-3 | | | |
| EMC protection requirements | Acc. to EN 60947-5-3 | | | |
| Ready delay | - | 5.5 | - | s |
| Risk time acc. to EN 60947-5-3 | - | - | 200 | ms |
| Risk time acc. to EN 60947-5-3, extension for each additional device | - | - | 10 | ms |
| Turn-on time | - | - | 400 | ms |
| Discrepancy time between both safety outputs acc. to EN 60947-5-3 | - | - | 10 | ms |
| Test pulse duration | - | - | 0.3 | ms |
| Test pulse interval | - | - | 100 | ms |
| Safety outputs F01A/F01B Semiconductor outputs, p-switching, short circuit-proof | | | | |
| - Output voltage U _{F01A} /U _{F01B} ²⁾ | | | | |
| HIGH U _{F01A} /U _{F01B} | U _B - 1.5 | - | U _B | V DC |
| LOW U _{F01A} /U _{F01B} | 0 | - | 1 | |
| Switching current per safety output | 1 | - | 150 | mA |
| Utilization category | DC-13 24 V 150 mA Caution: outputs must be protected with a free-wheeling diode in case of inductive loads | | | |
| Switching frequency | - | - | 0.25 | Hz |
| Monitoring outputs OD/C p-switching, short circuit-proof | | | | |
| Output voltage | 0.8 x U _B | - | U _B | V DC |
| Max. load | 1 | - | 50 | mA |
| Solenoid IMP (control input of guard locking solenoid) | | | | |
| Input voltage | | | | |
| - Guard locking not active (open) | 20.4 | - | 26.4 | V DC |
| - Guard locking active (closed) | 0 | - | 5 | |
| Solenoid current consumption I _{IMP} | | | | |
| - Guard locking not active (open) | 20 | - | 50 | mA |
| Connection rating at max. switching frequency | 3 | | | W |

| Parameter | Value | | | Unit |
|--|---|------|---------------------------------|-------|
| | min. | typ. | max. | |
| Duty cycle | 100 | | | % |
| Characteristics acc. to EN ISO 13849-1 and EN IEC 62061 | Monitoring of guard locking and the guard position | | Control of guard locking | |
| Category | 4 | | 3 | |
| Performance Level (PL) | PL e | | PL d | |
| PFD _D | 4.11 x 10 ⁻⁹ | | 1.03 x 10 ⁻⁷ | |
| Maximum SIL | 3 | | 2 | |
| Mission time | 20 | | 20 | years |

1) The following applies to devices with connecting cable: In areas where high-pressure cleaners are used, ensure that the high-pressure cleaner jet does not act directly on the connecting cable or the cable entry into the device. Potential damage due to the high-pressure cleaner can result in the degree of protection IP69K no longer being achieved.

2) Values at a switching current of 50 mA without taking into account the cable lengths.

16.1.1. Typical system times

Refer to the technical data for the exact values.

Ready delay: After switch-on, the device carries out a self-test. The system is ready for operation only after this time.

Turn-on time of safety outputs: The max. reaction time t_{on} is the time from the moment when the guard is locked to the moment when the safety outputs switch on.

Risk time according to EN 60947-5-3: The risk time is the maximum time until at least one of the safety outputs FO1A or FO1B switches off safely when the actuator is removed from the actuating range. This also applies if an internal or external fault occurs at this moment.

If several devices are operated in a series connection, the risk time of the overall device chain will increase with each device added. Use the following calculation formula:

$$t_r = t_{r,e} + (n \times t_i)$$

t_r = Total risk time

$t_{r,e}$ = Risk time for single device (see technical data)

t_i = Risk time extension per device

n = Number of additional devices (total number - 1)

Discrepancy time: The safety outputs FO1A and FO1B switch with a slight time offset. They have the same signal state no later than after the discrepancy time.

Test pulses at the safety outputs: The device generates its own test pulses on the safety outputs FO1A and FO1B. A downstream control system must tolerate these test pulses.

This can usually be set up in the control systems by parameter assignment. If parameter assignment is not possible for your control system or if shorter test pulses are required, contact the EUCHNER support team.

The test pulses are output only if the safety outputs are switched on.

16.2. Radio frequency approvals

FCC ID: 2AJ58-07

IC: 22052-07

FCC/IC-Requirements

This device complies with part 15 of the FCC Rules and with Industry Canada's licence-exempt RSSs. Operation is subject to the following two conditions:

- 1) This device may not cause harmful interference, and
- 2) this device must accept any interference received, including interference that may cause undesired operation.

Changes or modifications not expressly approved by the party responsible for compliance could void the user's authority to operate the equipment.

NOTE: This equipment has been tested and found to comply with the limits for a Class A digital device, pursuant to part 15 of the FCC Rules. These limits are designed to provide reasonable protection against harmful interference when the equipment is operated in a commercial environment. This equipment generates, uses, and can radiate radio frequency energy and, if not installed and used in accordance with the instruction manual, may cause harmful interference to radio communications.

Operation of this equipment in a residential area is likely to cause harmful interference in which case the user will be required to correct the interference at his own expense.

Le présent appareil est conforme aux CNR d'Industrie Canada applicables aux appareils radio exempts de licence. L'exploitation est autorisée aux deux conditions suivantes :

- (1) l'appareil ne doit pas produire de brouillage, et
- (2) l'utilisateur de l'appareil doit accepter tout brouillage radioélectrique subi, même si le brouillage est susceptible d'en compromettre le fonctionnement.

Supplier's Declaration of Conformity

47 CFR § 2.1077 Compliance Information

Unique Identifier:

CTM-LBI-BR series
CTM-IBI-BR series
CTM-CBI-BR series
CTM-L2-BR series
CTM-I2-BR series
CTM-C2-BR series
CTM-LBI-BP series
CTM-IBI-BP series
CTM-CBI-BP series
CTM-L2-BP series
CTM-I2-BP series
CTM-C2-BP series
CTM-L2-AS1B series
CTM-I2-AS1B series
CTM-LBI-AS1B series
CTM-IBI-AS1B series

Responsible Party – U.S. Contact Information

EUCHNER USA Inc.

1860 Jarvis Avenue
Elk Grove Village, Illinois 60007

+1 315 701-0315

info(at)euchner-usa.com

<http://www.euchner-usa.com>

16.3. Dimension drawing for safety switch CTM...

Necessary minimum travel + perm. overtravel

| Actuator | Length (L) | Necessary minimum travel (h ₁) + permissible overtravel (h ₂) | Total travel (t) |
|-----------|------------|---|------------------|
| A-BA1-... | 35 | 21 + 2 | 56 |
| A-BA5-... | 37 | 21 + 2 | 58 |

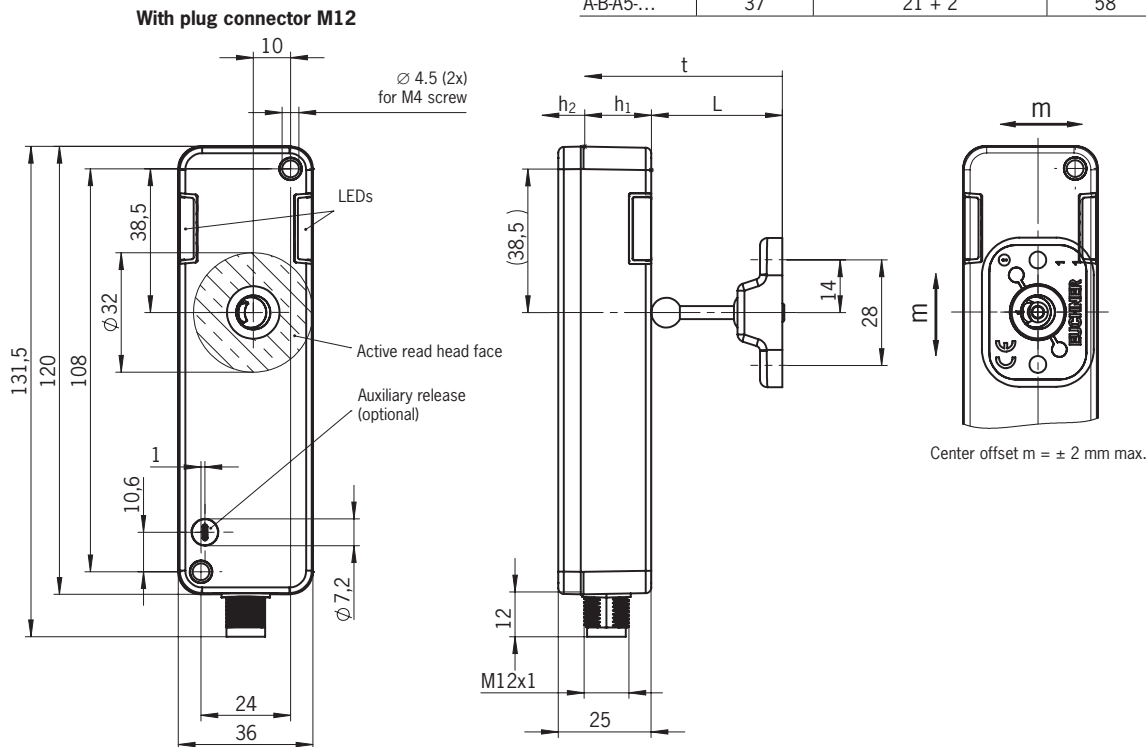

With connecting cable, 8-core

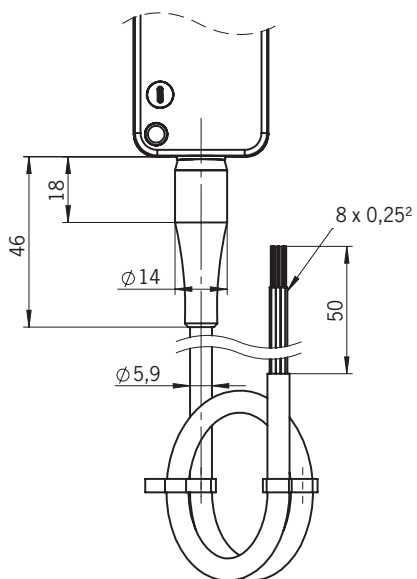

Min. door radius [mm]

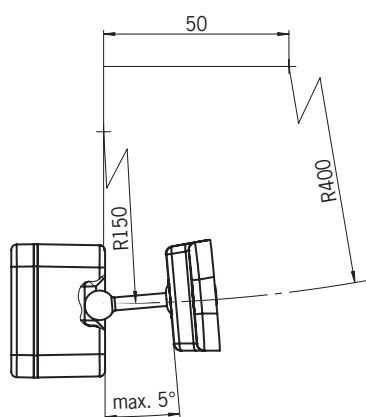

16.4. Technical data for actuator A-B-A1-A1-...

| Parameter | Value | | | Unit |
|-------------------------------|---|------|------|------|
| | min. | typ. | max. | |
| Material | | | | |
| - Housing | Ultradur black | | | |
| - Ball holder | Stainless steel | | | |
| - Elastomer | Fluorinated rubber (FKM) | | | |
| Resistance | Resistant to chemicals and oil | | | |
| Food safe | DIN EN 1672-2, EN ISO 14159, PAH category 3 | | | |
| Weight | 0.0194 | | | kg |
| Ambient temperature | -20 | - | +60 | °C |
| Degree of protection | IP65/IP67/IP69/IP69K | | | |
| Mechanical life | 1 x 10 ⁶ | | | |
| Locking force, max. | 1,300 | | | N |
| Locking force F _{Zh} | 1,000 | | | N |
| Installation position | Any | | | |
| Overtravel | 2 | | | mm |
| Power supply | Inductive via read head | | | |

16.4.1. Dimension drawing for actuator A-B-A1-A1-...

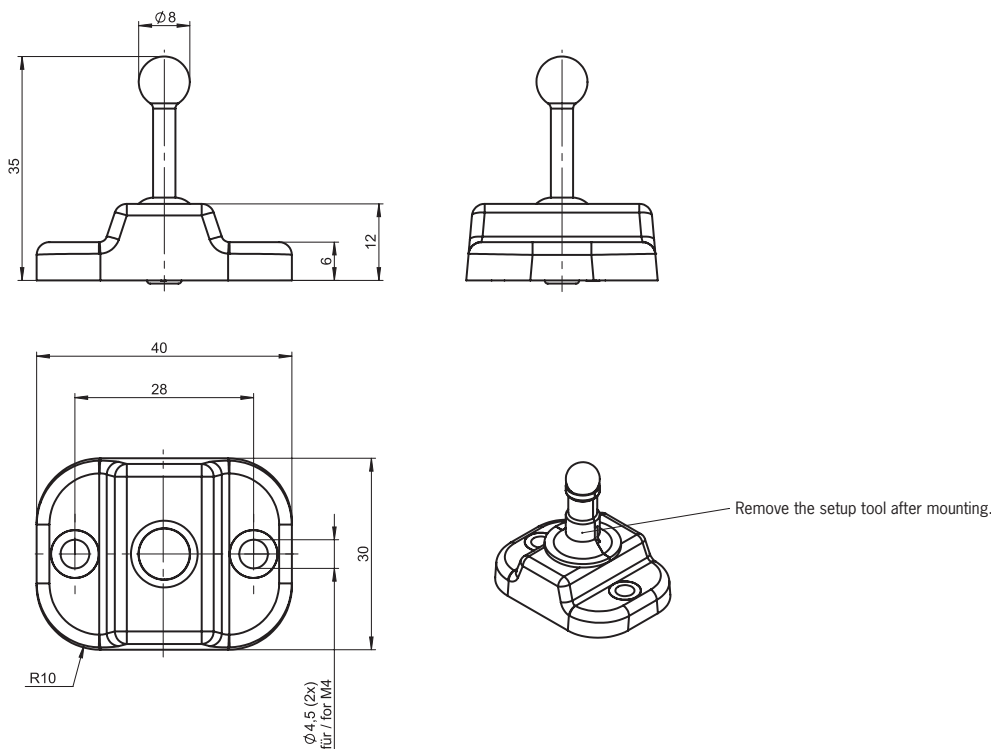

NOTICE

- › The actuator includes two non-removable safety screws.
- › Remove the setup tool after mounting the safety switch and actuator.

16.5. Technical data for actuator A-B-A5-A1-...

| Parameter | Value | | | Unit |
|-------------------------------|--------------------------------|------|------|------|
| | min. | typ. | max. | |
| Material | | | | |
| - Housing | Ultradur black | | | |
| - Ball holder | Stainless steel | | | |
| - Elastomer | NBR | | | |
| Resistance | Resistant to chemicals and oil | | | |
| Weight | 0.0194 | | | kg |
| Ambient temperature | -20 | - | +60 | °C |
| Degree of protection | IP65/IP67/IP69/IP69K | | | |
| Mechanical life | 1 x 10 ⁶ | | | |
| Locking force, max. | 1,300 | | | N |
| Locking force F _{Zh} | 1,000 | | | N |
| Installation position | Any | | | |
| Overtravel | 2 | | | mm |
| Power supply | Inductive via read head | | | |

16.5.1. Dimension drawing for actuator A-B-A5-A1-...

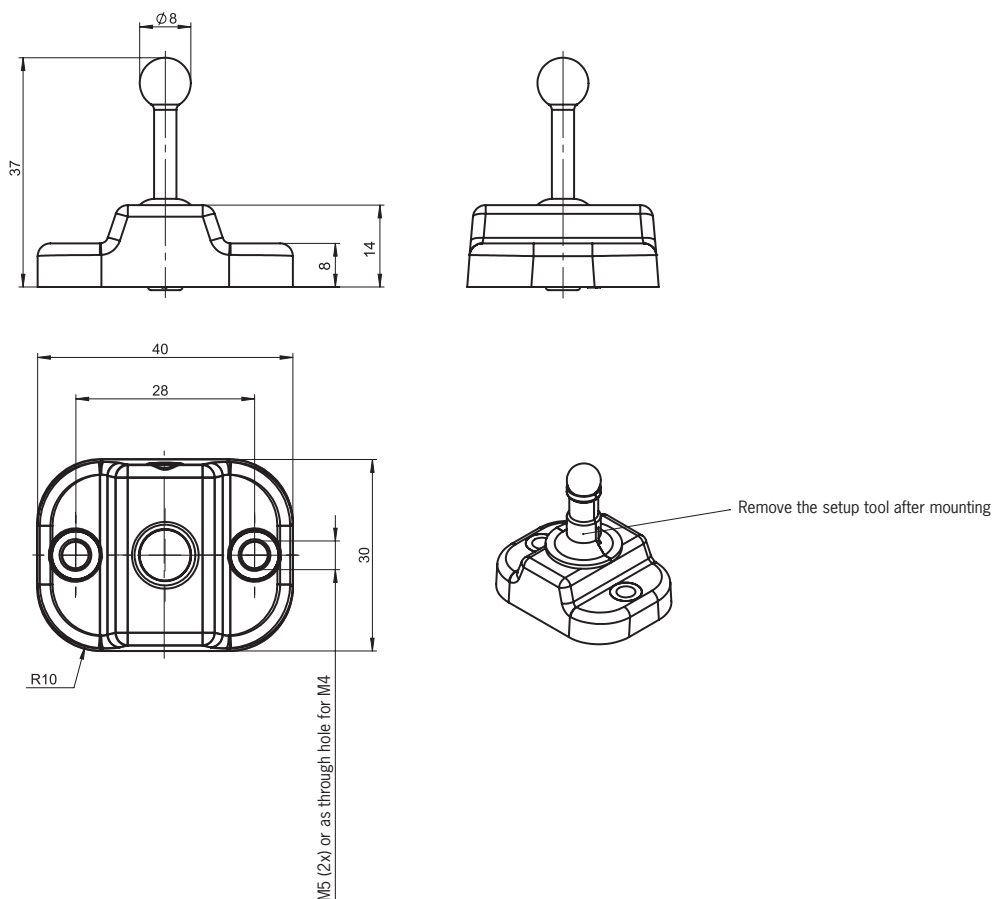

NOTICE

- › The actuator includes two non-removable safety screws.
- › Remove the setup tool after mounting the safety switch and actuator.

17. Ordering information and accessories



Tip!

Suitable accessories, e.g. cables or assembly material, can be found at www.euchner.com. To order, enter the order number of your item in the search box and open the item view. Accessories that can be combined with the item are listed in *Accessories*.

18. Inspection and service



WARNING

Danger of severe injuries due to the loss of the safety function.

- › If damage or wear is found, the complete switch and actuator assembly must be replaced. Replacement of individual parts or assemblies is not permitted.
- › Check the device for proper function at regular intervals and after every fault. For information about possible time intervals, refer to EN ISO 14119:2013, section 8.2.

Regular inspection of the following is necessary to ensure trouble-free long-term operation:

- › Check the switching function (see chapter 13.2. *Functional check on page 28*)
- › Check all additional functions (e.g., escape release, lockout bar, etc.)
- › Check the secure mounting of the devices and the connections
- › Check for contamination

No servicing is required. Repairs to the device are only allowed to be made by EUCHNER.



NOTICE

The year of manufacture is given in the laser marking at the bottom right corner. The current version number in the format (V X.X.X) can also be found on the device.

19. Service

If servicing is required, please contact:

EUCHNER GmbH + Co. KG
Kohlhammerstraße 16
70771 Leinfelden-Echterdingen
Germany

Service telephone:

+49 711 7597-500

E-mail:

support@euchner.de

Internet:

www.euchner.com

20. Declaration of conformity

The product complies with the requirements according to Machinery Directive 2006/42/EC.

The EU declaration of conformity can be found at www.euchner.com. Enter the order number of your device in the search box. The document is available under *Downloads*.

EUCHNER GmbH + Co. KG
Kohlhammerstraße 16
70771 Leinfelden-Echterdingen
Germany
info@euchner.de
www.euchner.com

Edition:
2525462-07-04/24
Title:
Operating Instructions Transponder-Coded Safety Switch
CTM-LBI-BP/BR
(translation of the original operating instructions)
Copyright:
© EUCHNER GmbH + Co. KG, 04/2024

Subject to technical modifications; no responsibility is accepted for the accuracy of this information.