

# **EUCHNER**

## **Operating Instructions**

**Transponder-Coded Safety Switch with Guard Locking for Process Protection  
CTM-C2-BP/BR-FLX High/Low Coding Level**

**EN**

## Contents

<b>1.</b>	<b>About this document</b> .....	<b>4</b>
1.1.	Scope.....	4
1.2.	Target group .....	4
1.3.	Key to symbols.....	4
1.4.	Supplementary documents .....	4
<b>2.</b>	<b>Correct use</b> .....	<b>5</b>
<b>3.</b>	<b>Description of the safety function</b> .....	<b>6</b>
<b>4.</b>	<b>Exclusion of liability and warranty</b> .....	<b>7</b>
<b>5.</b>	<b>General safety precautions</b> .....	<b>7</b>
<b>6.</b>	<b>Function</b> .....	<b>8</b>
6.1.	Monitoring of guard locking for process protection.....	8
6.2.	Monitoring outputs/status bits .....	8
6.2.1.	Door position signal OD.....	8
6.2.2.	Diagnostic signal OI .....	8
6.2.3.	Guard locking signal OL .....	8
6.2.4.	Status signal OM.....	9
6.2.5.	Locking element signal OLS.....	9
6.2.6.	Communication connection C.....	9
6.3.	Guard locking for process protection.....	9
6.4.	Switching states .....	10
<b>7.</b>	<b>Manual release</b> .....	<b>11</b>
7.1.	Auxiliary release.....	11
<b>8.</b>	<b>Mounting</b> .....	<b>12</b>
<b>9.</b>	<b>Electrical connection</b> .....	<b>14</b>
9.1.	Notes about c(U)us.....	15
9.2.	Safety in case of faults.....	15
9.3.	Fuse protection for power supply .....	15
9.4.	Requirements for connecting cables.....	16
9.5.	Connector assignment of safety switch CTM-...-BP-...-SA-... with plug connector M12, 8-pin.....	16
9.6.	Notes on operation with safe control systems.....	17
9.7.	Connection without and with IO-Link communication.....	17
9.7.1.	Connection without IO-Link communication .....	17
9.7.2.	Connection with IO-Link communication.....	17
<b>10.</b>	<b>Connection of a single CTM-BP/BR (separate operation)</b> .....	<b>18</b>

<b>11.</b>	<b>Connection of several devices in a chain (series connection)</b> .....	<b>19</b>
11.1.	Series connection with wiring in the control cabinet.....	19
11.2.	Series connection with Y-distributors .....	19
11.2.1.	Maximum cable lengths with BR switch chains.....	20
11.2.2.	Determining cable lengths .....	20
11.2.3.	Connector assignment of Y-distributor for series connection without IO-Link communication .....	21
<b>12.</b>	<b>Using communication data</b> .....	<b>23</b>
12.1.	Connection to a BR/IO-Link Gateway GWY-CB.....	23
12.2.	Connection to a safety relay ESM-CB.....	23
12.3.	Overview of the communication data .....	24
12.3.1.	Cyclical data (process data).....	24
12.3.2.	Acyclical data (device data and events).....	25
<b>13.</b>	<b>Setup</b> .....	<b>26</b>
13.1.	Configuring device and teaching-in actuator for the first time.....	26
13.2.	Teaching-in a new actuator .....	26
13.3.	Functional check.....	28
13.3.1.	Mechanical function test.....	28
13.3.2.	Electrical function test.....	28
<b>14.</b>	<b>Factory reset</b> .....	<b>29</b>
<b>15.</b>	<b>Status and error messages</b> .....	<b>29</b>
15.1.	LED displays .....	29
15.2.	Status messages.....	30
15.3.	Error messages.....	31
15.4.	Acknowledging error messages.....	32
<b>16.</b>	<b>Technical data</b> .....	<b>33</b>
16.1.	Technical data for safety switch CTM-C2-BP/BR .....	33
16.1.1.	Typical system times.....	34
16.2.	Radio frequency approvals.....	35
16.3.	Dimension drawing for safety switch CTM... ..	36
16.4.	Technical data for actuator A-FLX-B-0.-A1-A1-... ..	37
16.4.1.	Dimension drawing for actuator A-FLX-B-0.-A1-A1-.....	37
<b>17.</b>	<b>Ordering information and accessories</b> .....	<b>38</b>
<b>18.</b>	<b>Inspection and service</b> .....	<b>38</b>
<b>19.</b>	<b>Service</b> .....	<b>38</b>
<b>20.</b>	<b>Declaration of conformity</b> .....	<b>38</b>

## 1. About this document

### 1.1. Scope







These operating instructions are valid for all safety switches CTM-C2-BP/BR...-FLX from version V1.0.X to version V2.0.X. These operating instructions, the document *Safety information* and any available data sheet form the complete user information for your device.

	<p><b>Important!</b></p> <p>Make sure to use the operating instructions valid for your product version. Please contact the EUCHNER support team if you have any questions.</p>
---	--

### 1.2. Target group





Design engineers and installation planners for safety systems on machines, as well as setup and servicing staff possessing special expertise in handling safety components.

### 1.3. Key to symbols

Symbol/depiction	Meaning
	Monitoring of guard locking for process protection active
	Monitoring of guard locking for process protection optional
	Printed document
	Document is available for download at <a href="http://www.euchner.com">www.euchner.com</a>
 <b>DANGER</b> <b>WARNING</b> <b>CAUTION</b>	<p>Safety precautions</p> <p><b>Danger</b> of death or severe injuries</p> <p><b>Warning</b> about possible injuries</p> <p><b>Caution</b> slight injuries possible</p>
 <b>NOTICE</b> <b>Important!</b>	<p><b>Notice</b> about possible device damage</p> <p><b>Important</b> information</p>
<b>Tip</b>	Useful information

### 1.4. Supplementary documents

The overall documentation for this device consists of the following documents:

Document title (document number)	Contents	
Safety information (2525460)	Basic safety information	
Operating instructions (MAN20001574)	(this document)	
Declaration of conformity	Declaration of conformity	
Possibly available data sheet	Item-specific information about deviations or additions	 



### Important!

Always read all documents to gain a complete overview of safe installation, setup and use of the device. The documents can be downloaded from [www.euchner.com](http://www.euchner.com). For this purpose enter the doc. no. in the search box.

## 2. Correct use

Safety switches series CTM-C2-... are interlocking devices with guard locking solenoid for process protection (type 4) without safe guard lock monitoring. The device complies with the requirements according to EN 60947-5-3. Devices with high coding level evaluation (HC) possess a high coding level, devices with low coding level evaluation (LC) possess a low coding level.

The device can be configured with the aid of a function actuator. Depending on the function actuator taught-in, the monitoring of the guard locking for process protection is permanently active or available as an additional option.

Table 1: System components

Safety switch	Function actuator	
	Monitoring of guard locking for process protection	
	Active 	Optional 
CTM-C2-BP/BR-FLX... High/Low Coding Level	A-FLX-B-08-A1-A1-170487	A-FLX-B-09-A1-A1-170488



### The following applies to active guard lock monitoring for process protection:

In combination with a movable guard and the machine control, this safety component prevents dangerous machine functions from occurring while the guard is open. A stop command is triggered if the guard is opened during the dangerous machine function or the guard locking is released.

This means:

- Starting commands that cause a dangerous machine function must become active only when the guard is closed and locked.
- Opening the guard must trigger a stop command.
- Closing and locking a guard must not cause automatic starting of a dangerous machine function. A separate start command must be issued. For exceptions, refer to EN ISO 12100 or relevant C-standards.



### The following applies to optional monitoring of guard locking for process protection:

In combination with a movable guard and the machine control, this safety component prevents dangerous machine functions from occurring while the guard is open. A stop command is triggered if the guard is opened during the dangerous machine function.

This means:

- Starting commands that cause a dangerous machine function must become active only when the guard is closed.
- Opening the guard must trigger a stop command.
- Closing a guard must not cause automatic starting of a dangerous machine function. A separate start command must be issued. For exceptions, refer to EN ISO 12100 or relevant C-standards.

Before the device is used, a risk assessment must be performed on the machine, e.g. in accordance with the following standards:

- EN ISO 13849-1
- EN ISO 12100
- IEC 62061

Correct use includes observing the relevant requirements for installation and operation, particularly based on the following standards:

- › EN ISO 13849-1
- › EN ISO 14119
- › EN 60204-1

The safety switch is allowed to be operated only in conjunction with the intended EUCHNER actuators and the related connection components from EUCHNER. If different actuators or other connection components are used, EUCHNER provides no warranty for safe function.

Safety switches in the version CTM-...-BR can be integrated into a BR switch chain. Connection of several devices in a BR device chain is permitted only using devices intended for series connection in a BR device chain. Check this in the specifications of the device in question.



**Important!**

- › The user is responsible for the proper integration of the device into a safe overall system. For this purpose, the overall system must be validated, e.g. in accordance with EN ISO 13849-1.
- › It is only allowed to use components that are permissible according to *Table 1: System components*.

### 3. Description of the safety function

Devices from this series feature the following safety functions:

**Monitoring of the guard position (interlocking device according to EN ISO 14119)**

- › Safety function: the safety outputs are switched off when the guard is open (see chapter 6. *Function on page 8*).
- › Safety characteristics: category, Performance Level, PFH<sub>D</sub> (see chapter 16. *Technical data on page 33*).

**The following additionally applies in a BR series connection:**

- › The safety outputs are switched on only when the device receives a corresponding signal from its predecessor in the chain.



**NOTICE**

You can regard the complete BR device chain as one subsystem during calculation. The following calculation method applies to the PFH<sub>D</sub> value:

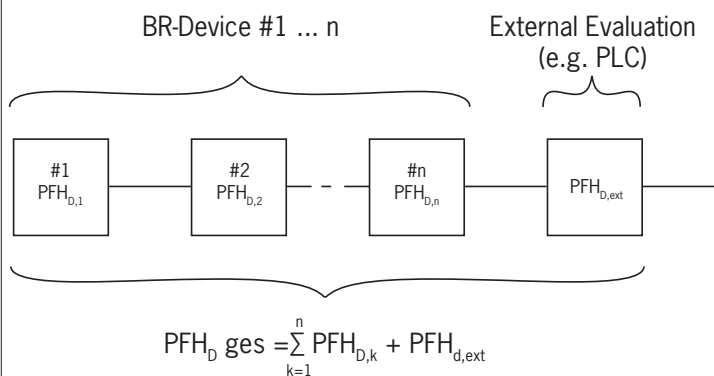

## 4. Exclusion of liability and warranty

In case of failure to comply with the conditions for correct use stated above, or if the safety regulations are not followed, or if any servicing is not performed as required, liability will be excluded and the warranty void.

## 5. General safety precautions

Safety switches fulfill personnel protection functions. Incorrect installation or tampering can lead to fatal injuries to personnel.

Check the safe function of the guard particularly

- › after any setup work
- › after the replacement of a system component
- › after an extended period without use
- › after every fault
- › after any reconfiguration of the device

Independent of these checks, the safe function of the guard should be checked at suitable intervals as part of the maintenance schedule.



### WARNING

Danger to life due to improper installation or due to bypassing (tampering). Safety components fulfill a personnel protection function.

- › Safety components must not be bypassed, turned away, removed or otherwise rendered ineffective. On this topic pay attention in particular to the measures for reducing the possibility of bypassing according to EN ISO 14119:2013, section 7.
- › The switching operation must be triggered only by actuators designated for this purpose.
- › Prevent bypassing by means of replacement actuators (only for low coding level evaluation). For this purpose, restrict access to actuators and to keys for releases, for example.
- › Damaged actuators can lead to limited prevention of inadvertent locking position (faulty closure protection) when the machine is switched on. The guard locking function can no longer be ensured if an actuator is broken. Opening the door will immediately switch off the safety outputs. Regularly check the actuator for mechanical damage.
- › Mounting, electrical connection and setup only by authorized personnel possessing the following knowledge:
  - specialist knowledge in handling safety components
  - knowledge about the applicable EMC regulations
  - knowledge about the applicable regulations on operational safety and accident prevention.



### Important!

Prior to use, read the operating instructions and keep these in a safe place. Ensure the operating instructions are always available during mounting, setup and servicing. You can download the operating instructions from [www.euchner.com](http://www.euchner.com).

## 6. Function

The device monitors the position of movable guards.

The system consists of the following components: coded actuator (transponder) and switch.

Whether the device learns the complete actuator code (HC) or not (LC) depends on the respective version.

- **Devices with high coding level evaluation (HC):** The actuator must be assigned to the safety switch by a teach-in operation so that it is detected by the system. This unambiguous assignment ensures a particularly high level of protection against tampering. The system thus possesses a high coding level.
- **Devices with low coding level evaluation (LC):** With low coding level evaluation a specific code is not requested but instead it is only checked whether the actuator is of a type that can be detected by the system. There is no exact comparison of the actuator code with the taught-in code in the safety switch. The system possesses a low coding level.

When the guard is closed, the actuator is moved into the safety switch. Guard locking can be activated only when the actuator is located in the switch (prevention of inadvertent locking position (faulty closure protection)). When the operating distances are reached, power is supplied to the actuator by the switch and data are transferred.

The door position signal OD is set when a permissible code is detected. Guard locking is activated automatically if voltage is present at the control input IMP. The switching conditions for the safety outputs are dependent on the configuration of the monitoring of the guard locking for process protection (see chapter 6.4. *Switching states on page 10*).

In the event of a fault in the safety switch, the safety outputs are switched off and the DIA LED illuminates red. The occurrence of faults is detected at the latest on the next demand to close the safety outputs (e.g. on starting).

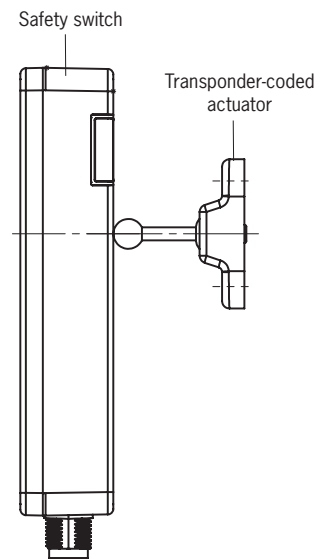

### 6.1. Monitoring of guard locking for process protection

The device is configured with the aid of the function actuator. Depending on the function actuator taught-in, the monitoring of the guard locking for process protection is permanently active or available as an additional option. Further information about the possible settings is available in chapter 13.1. *Configuring device and teaching-in actuator for the first time on page 26*.

- L **The following applies to active guard lock monitoring for process protection:**  
All versions feature two safe outputs for monitoring the guard locking for process protection. The safety outputs FO1A and FO1B are switched off and the guard locking signal OL is cleared when guard locking is released.

- I **The following applies to optional monitoring of guard locking for process protection:**  
All versions feature two safe outputs for monitoring the door position as well as the status signal OL for monitoring the guard locking for process protection; this signal can be evaluated optionally. The safety outputs FO1A and FO1B are switched off and the door position signal OD is cleared when the guard is opened.

### 6.2. Monitoring outputs/status bits

Depending on version, the signals listed in the following are available as a status bit or at the monitoring output. The status bits are evaluated via the BR/IO-Link Gateway. Please refer to the corresponding data sheet for further information.

#### 6.2.1. Door position signal OD

The door position signal is sent as soon as the actuator is inserted into the switch head (state: guard closed and not locked). The signal is also present if the guard locking is active.

#### 6.2.2. Diagnostic signal OI

The diagnostic signal is present if there is an error (switch-on condition as for DIA LED).

#### 6.2.3. Guard locking signal OL

The guard locking signal is present if the guard locking is active.



### 6.2.4. Status signal OM

The status signal is present if the device's safety outputs are switched.

### 6.2.5. Locking element signal OLS

The locking element signal is present if the locking element is stuck and guard locking cannot be released. The signal is reset as soon as the actuator is no longer under tensile stress or the locking element is no longer blocked.

### 6.2.6. Communication connection C

A monitoring output with the suffix C has the additional function of providing a communication connection to a BR/IO-Link Gateway. The switch delivers cyclical and acyclical data. You will find an overview of the communication data in chapter 12. *Using communication data on page 23.*

If no BR/IO-Link Gateway is connected, this output behaves like a monitoring output.

## 6.3. Guard locking for process protection

(guard locking actuated by power-ON and released by spring force)



### Important!

Malfunctions due to incorrect use.

- › The actuator must not be under tensile stress during release.

The magnetically actuated guard locking operates in accordance with the open-circuit current principle. If the voltage is interrupted at the solenoid, the guard locking is released and the guard can be opened directly.

The guard can be opened as long as no voltage is applied to the guard locking solenoid.



If the voltage is applied to the guard locking solenoid, the guard locking pin is held in the extended position and the guard is locked.

**Activating guard locking:** close guard, apply voltage to control input IMP and apply operating voltage UB.

**Releasing guard locking:** interrupt voltage at control input IMP or interrupt operating voltage UB.

## 6.4. Switching states

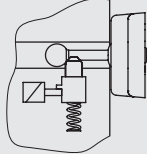
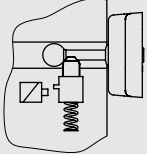
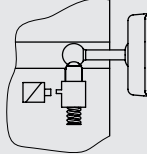
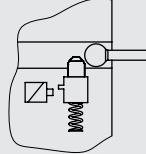
The detailed switching states for your switch can be found in chapter 15. *Status and error messages on page 29.* All safety outputs, signals and display LEDs are described there.

	Guard closed and locked	Guard closed and not locked		Guard being opened	Guard open
					
<b>Control input IMP</b>	on	off		off	irrelevant
Safety outputs F01A and F01B	on	off 	on 	off	off
Guard locking signal OL	on	off		off	off
Door position signal OD	on	on		on	off

### 7. Manual release



#### Important!

- › All release functions latch when the device is electrically isolated.
- › Guard locking remains released when the release function is reset.

Some situations require the guard locking to be released manually (e.g. malfunctions or an emergency). A function test must be performed after release.

Further information on this topic can be found in the standard EN ISO 14119:2013, section 5.7.5.1. The device can feature the following release functions:

#### 7.1. Auxiliary release

In the event of malfunctions, the guard locking can be released with the auxiliary release irrespective of the state of the solenoid.



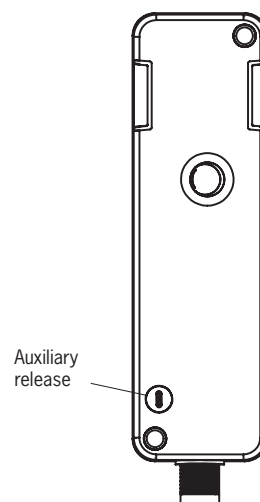

#### Important!

- › The actuator must not be under tensile stress during manual release.
- › To prevent tampering, the auxiliary release must be sealed with sealing lacquer, for example, before the switch is set up.
- › Loss of the release function due to mounting errors or damage during mounting.
- › Check the release function every time after mounting.
- › After manual release, the solenoid must be energized briefly to re-establish guard locking.
- › The auxiliary release is not a safety function.
- › The correct function must be checked at regular intervals.
- › Observe the notes on any available data sheets.



#### Actuating auxiliary release

1. Remove seal label or make a hole.
2. Using a screwdriver, turn the auxiliary release to  in the direction of the arrow.
  - ➔ Guard locking is released.
  - ➔ The safety outputs are switched off.
  - ➔ The guard locking signal OL is switched off. The diagnostic signal OI is switched on.
3. Using a screwdriver, turn the auxiliary release to  in the opposite direction to the arrow to reset.
4. Seal with sealing lacquer.
5. Close the guard.
6. Carry out reset; see *Plausibility errors* in chapter 15.3. *Error messages*.
  - ➔ The device operates normally again.
7. Check correct function of the device.

## 8. Mounting



### CAUTION

Safety switches must not be bypassed (bridging of contacts), turned away, removed or otherwise rendered ineffective.

- › Observe EN ISO 14119:2013, section 7, for information about reducing the possibilities for bypassing an interlocking device.



### NOTICE

Risk of damage to equipment and malfunctions as a result of incorrect installation.

- › Safety switches and actuators must not be used as an end stop.
- › Observe EN ISO 14119:2013, sections 5.2 and 5.3, for information about mounting the safety switch and the actuator.
- › Protect the switch against damage, as well as against penetrating foreign objects such as swarf, sand and blasting shot, etc.
- › Observe the min. door radii (see chapter 16.3. *Dimension drawing for safety switch CTM... on page 36*).
- › Observe the maximum permissible angle between switch and actuator (max. 5°).
- › Fasten the actuator using non-removable safety screws.
- › Observe the tightening torque for mounting the switch and the actuator (max. 2.9 Nm).
- › The rear side of the switch and the actuator's plate must lie fully on the mounting surface.
- › When installing the switch in a concealed position, bear in mind that the active face of the read head must be kept clear (see chapter 16.3. *Dimension drawing for safety switch CTM... on page 36*).
- › Actuator and safety switch must be mounted such that the actuator is perpendicularly and completely inserted into the switch when the guard is closed. The guard locking function is not ensured if mounting is incorrect.
- › The auxiliary release must be sealed before setup, e.g. with sealing lacquer.
- › The following applies to devices with connecting cable: In areas where high-pressure cleaners are used, ensure that the high-pressure cleaner jet does not act directly on the connecting cable or the cable entry into the device. Potential damage due to the high-pressure cleaner can result in the degree of protection IP69K no longer being achieved.
- › When mounting several safety switches, observe the stipulated minimum distance to avoid mutual interference.

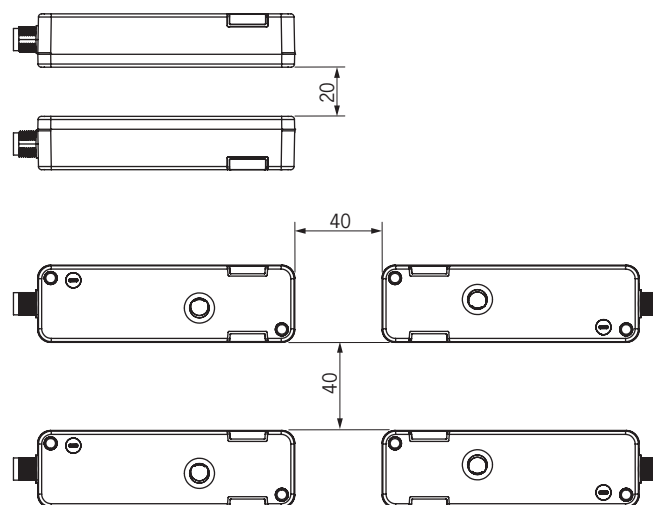



The following applies to optional monitoring of guard locking for process protection:



**Important!**

- › From the assured release distance  $S_{ar}$ , the safety outputs are safely shut down. To achieve the assured release distance  $S_{ar}$  the actuator must be pulled completely out of the switch head.
- › To achieve the assured operating distances  $S_{a0}$  the actuator must be inserted completely into the switch head.

## 9. Electrical connection

The following connection options are available:

- › Separate operation
- › Series connection with wiring in the control cabinet
- › Series connection with Y-distributors
- › Connection without IO-Link communication
- › Connection with IO-Link communication



### WARNING

In the event of a fault, loss of the safety function due to incorrect connection.

- › To ensure safety, both safety outputs must always be evaluated.
- › Monitoring outputs must not be used as safety outputs.
- › Lay the connecting cables with protection to prevent short circuits.



### CAUTION

Risk of damage to equipment or malfunctions as a result of incorrect connection.

- › Do not use a control system with pulsing or switch off the pulsing function in your control system. The device generates its own test pulses on the safety outputs. A downstream control system must tolerate these test pulses, which may have a length of up to 300 µs. Depending on the inertia of the downstream device (control system, relay, etc.), this can lead to short switching processes. The test pulses are output with the safety outputs switched off only during device start.
- › The inputs on a connected evaluation unit must be positive switching, as the two outputs on the safety switch deliver a level of +24 V in the switched-on state.
- › All electrical connections must either be isolated from the mains supply by safety transformers according to IEC 61558-2-6 with limited output voltage in the event of a fault, or by other equivalent insulation measures (SELV/PELV).
- › All electrical outputs must have an adequate protective circuit for inductive loads. The outputs must be protected with a free-wheeling diode for this purpose. Varistors and RC interference suppression units must not be used.
- › Power devices which are a powerful source of interference must be installed in a separate location away from the input and output circuits for signal processing. The cable routing for safety circuits should be as far away as possible from the cables of the power circuits.
- › To avoid EMC interference, the physical environmental and operating conditions at the installation site of the device must comply with the requirements according to the standard EN 60204-1 (EMC).
- › Pay attention to any interference fields from devices such as frequency converters or induction heating systems. Observe the EMC instructions in the manuals from the respective manufacturer.



### Important!

If the device does not appear to function when the operating voltage is applied (e.g. the green STATE LED does not flash), the safety switch must be returned to EUCHNER.

### 9.1. Notes about



#### Important!

- › This device is intended to be used with a Class 2 power source in accordance with UL1310. As an alternative an LV/C (Limited Voltage/Current) power source with the following properties can be used:  
This device shall be used with a suitable isolating source in conjunction with a fuse in accordance with UL248. The fuse shall be rated max. 3.3 A and be installed in the max. 30 V DC power supply to the device in order to limit the available current to comply with the UL requirements. Please note possibly lower connection ratings for your device (refer to the technical data).
- › For use and application as per the requirements of UL <sup>1)</sup> a connecting cable listed under the UL category code CYJV/7, min. 24 AWG, min. 80 °C, must be used.

1) Note on the scope of the UL approval: The devices have been tested as per the requirements of UL508 and CSA/C22.2 no. 14 (protection against electric shock and fire).

### 9.2. Safety in case of faults

- › The operating voltage at UB and the solenoid operating voltage at IMP are reverse polarity protected.
- › The safety outputs FO1A/FO1B are short circuit-proof.
- › A short circuit between the safety outputs is detected on starting or when the safety outputs are activated by the device.
- › A short circuit in the cable can be excluded by laying the cable with protection.

### 9.3. Fuse protection for power supply

The power supply must be provided with fuse protection depending on the number of switches and the current required for the outputs. The following rules apply:

#### Max. current consumption of an individual switch $I_{max}$

$$I_{max} = I_{UB} + I_{FO1A+FO1B} + I_{OX} + I_{IMP}$$

$$I_{UB} = \text{Switch operating current (max. 500 mA)}$$

$$I_{OX} = \text{Load current of monitoring outputs (max. 50 mA per monitoring output)}$$

$$I_{FO1A+FO1B} = \text{Load current of safety outputs FO1A + FO1B (2 x max. 150 mA)}$$

$$I_{IMP} = \text{Switching current of solenoid control input (max. 50 mA)}$$



#### Important!

If there are further monitoring outputs, their load current must also be taken into account.

#### Max. current consumption of a switch chain $\Sigma I_{max}$

$$\Sigma I_{max} = I_{FO1A+FO1B} + n \times (I_{UB} + I_{OX} + I_{IMP})$$

$$n = \text{Number of connected switches}$$

## 9.4. Requirements for connecting cables



### CAUTION

Risk of damage to equipment or malfunctions as a result of incorrect connecting cables.

- › Use connection components and connecting cables from EUCHNER.
- › If other connection components are used, the requirements in the following table apply. EUCHNER provides no warranty for safe function in case of failure to comply with these requirements.

Observe the following requirements with respect to the connecting cables:

Parameter	Value	Unit
	M12/8-pin	
Recommended cable type	LIYY 8 x 0.34	mm <sup>2</sup>
Cable	8 x 0.34	mm <sup>2</sup>
Cable resistance R max.	80	Ω/km
Inductance L max.	0.65	mH/km
Capacitance C max.	120	nF/km

## 9.5. Connector assignment of safety switch CTM-...-BP-...-SA-... with plug connector M12, 8-pin

Plug connector (view of connection side)	Pin	Designation	Function	Conductor coloring of connecting cable <sup>1)</sup>
<p>1 x M12</p>	1	IMP	Solenoid control input, 24 V DC	WH
	2	UB	Electronics and solenoid operating voltage, 24 V DC	BN
	3	F01A	Safety output, channel A <b>Active monitoring of guard locking for process protection:</b> ON if door is closed and locked. <b>Optional monitoring of guard locking for process protection:</b> ON if door is closed.	GN
	4	F01B	Safety output, channel B <b>Active monitoring of guard locking for process protection:</b> ON if door is closed and locked. <b>Optional monitoring of guard locking for process protection:</b> ON if door is closed.	YE
	5	OI	Diagnostic monitoring output	GY
	6	OD/C	Door position monitoring output/communication	PK
	7	OL	Guard lock monitoring output	BU
	8	OVUB	Electronics and solenoid operating voltage, 0 V DC	RD

1) Only for standard EUCHNER connecting cable



### 9.6. Notes on operation with safe control systems

Observe the following guidelines for connection to safe control systems:

- › Use a common power supply for the control system and the connected safety switches.
- › A pulsed power supply must not be used for UB. Tap the supply voltage directly from the power supply unit. If the power supply is connected to a terminal of a safe control system, this output must provide sufficient electrical current.
- › The safety outputs F01A and F01B can be connected to the safe inputs of a control system. Prerequisite: the input must be suitable for pulsed safety signals (OSSD signals, e.g. from light grids). The control system must tolerate test pulses on the input signals. This normally can be set up by parameter assignment in the control system. Observe the notes of the control system manufacturer. For the test pulse duration of your safety switch, refer to chapter 16. *Technical data on page 33.*
- › With series connection: always connect inputs F11A and F11B directly to a power supply unit or to outputs F01A and F01B of another EUCHNER BR device. Pulsed signals must not be present at inputs F11A and F11B.

A detailed example of connecting and setting the parameters of the control system is available for many devices at [www.euchner.com](http://www.euchner.com), in the area *Downloads/Applications/CTM*. The features of the respective device are dealt with there in greater detail.

### 9.7. Connection without and with IO-Link communication

#### 9.7.1. Connection without IO-Link communication

Only the safety and monitoring outputs are switched with this connection method.

With a series connection, the safety signals are looped through from device to device.

#### 9.7.2. Connection with IO-Link communication

If, in addition to the safety function, detailed monitoring and diagnostic data are to be processed, a BR/IO-Link Gateway is required. To poll the communication data from the connected device, communication connection C is routed to the BR/IO-Link Gateway.

You will find further information in the operating instructions for your BR/IO-Link Gateway.

## 10. Connection of a single CTM-BP/BR (separate operation)



### WARNING

In the event of a fault, loss of the safety function due to incorrect connection.  
 ▶ To ensure safety, both safety outputs F01A and F01B must always be evaluated.



### Important!

The example shows only an excerpt that is relevant for connection of the CTM system. The example illustrated here does not show complete system planning. The user is responsible for safe integration into the overall system. Detailed application examples can be found at [www.euchner.com](http://www.euchner.com). Simply enter the order number of your switch in the search box. You will find all available connection examples for the device in *Downloads*.

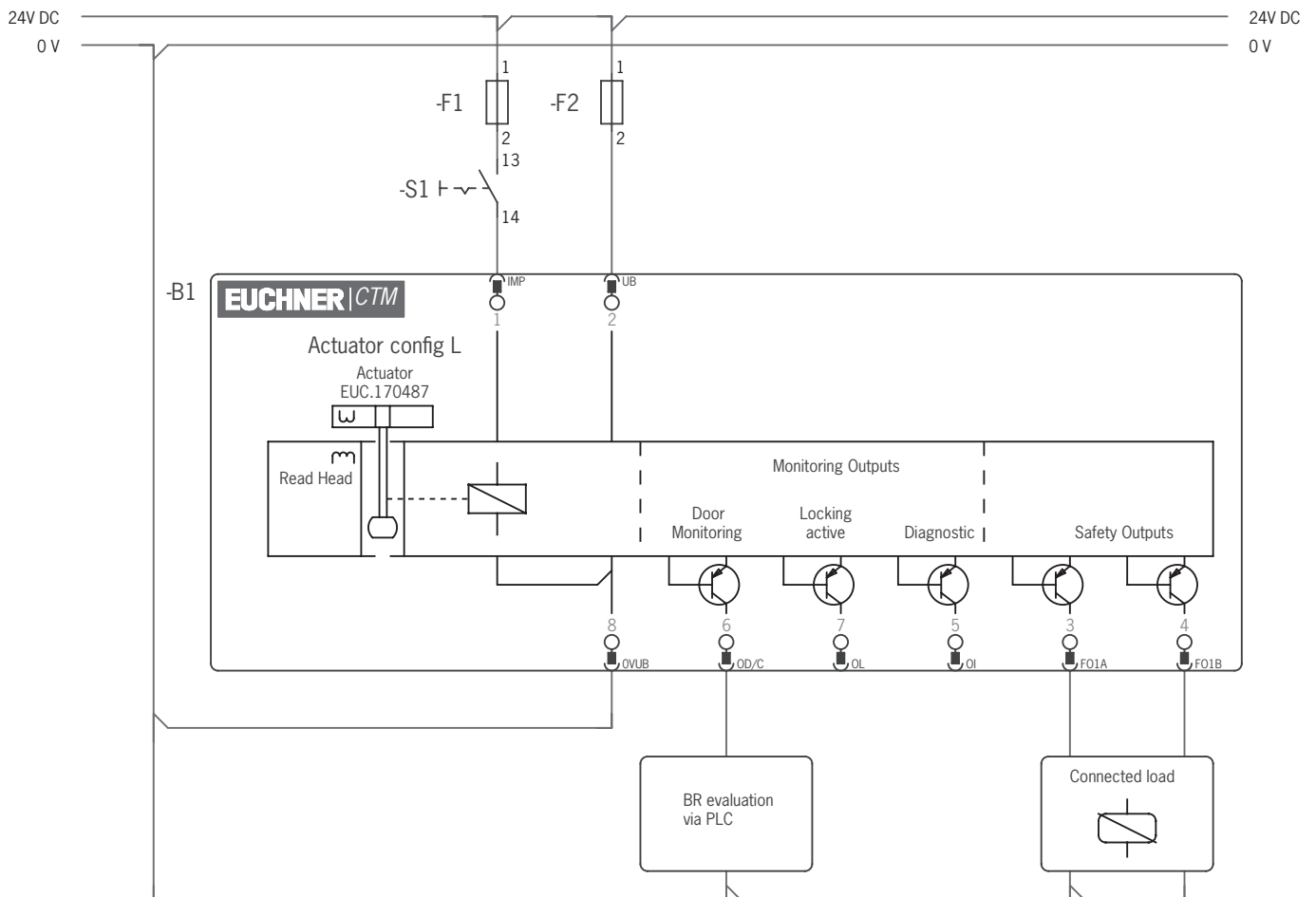

Fig. 1: Connection example for separate operation (principle of operation)

## 11. Connection of several devices in a chain (series connection)



### WARNING

In the event of a fault, loss of the safety function due to incorrect connection.  
 › To ensure safety, both safety outputs FO1A and FO1B must always be evaluated.



### Important!

› A BR device chain may contain a maximum of 20 devices.  
 › The example shows only an excerpt that is relevant for connection of the CTM system. The example illustrated here does not show complete system planning. The user is responsible for safe integration into the overall system. Detailed application examples can be found at [www.euchner.com](http://www.euchner.com). Simply enter the order number of your switch in the search box. You will find all available connection examples for the device in *Downloads*.  
 › Make sure you use the correct Y-distributors. See chapter 11.2.3. *Connector assignment of Y-distributor for series connection without IO-Link communication on page 21*.

### 11.1. Series connection with wiring in the control cabinet

The series connection can be implemented via additional terminals in a control cabinet.



### Important!

In case of series connection with IO-Link communication:  
 › The safety outputs are permanently assigned to the respective safety inputs of the downstream switch. FO1A must be routed to FI1A and FO1B to FI1B.  
 › If the connections are interchanged (e.g. FO1A to FI1B), the downstream device will enter the fault state.

### 11.2. Series connection with Y-distributors

The series connection is shown here based on the example of the version with plug connector M12. The switches are connected one behind the other with the aid of pre-assembled connecting cables and Y-distributors. If a safety door is opened or if a fault occurs on one of the switches, the system shuts down the machine.

11.2.1. Maximum cable lengths with BR switch chains



**Important!**

The maximum number of switches in a BR switch chain depends on many factors, including the cable length. This case example shows a standard application. You will find further connection examples at [www.euchner.com](http://www.euchner.com).

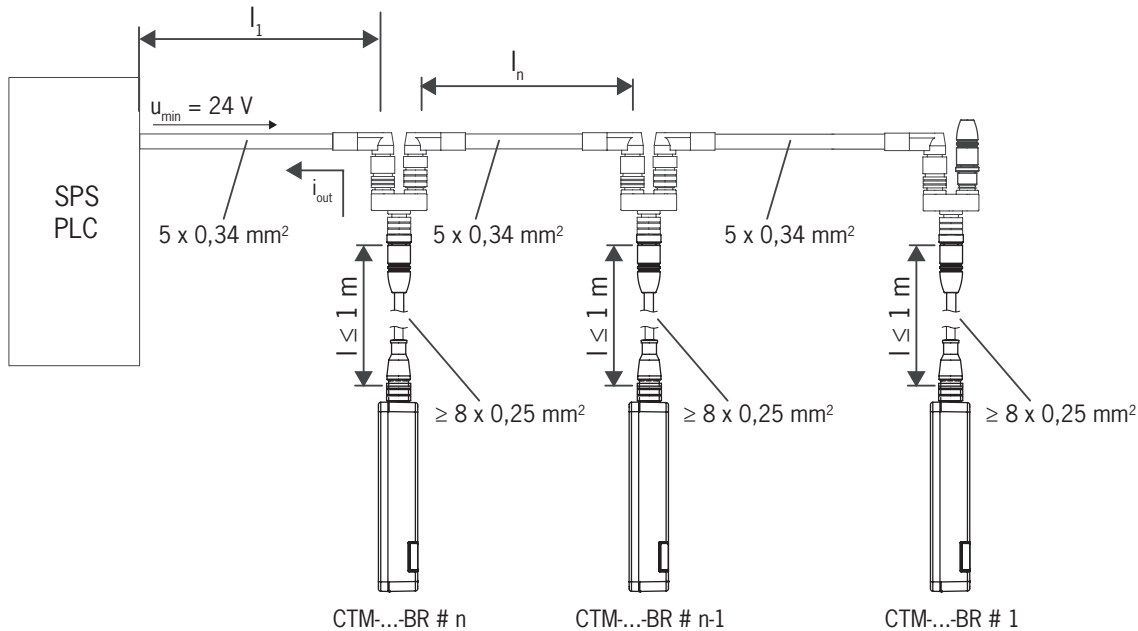

11.2.2. Determining cable lengths

n Max. number of switches depending on the cable length	I <sub>F01A/F01B</sub> (mA) Possible output current per channel F01A/F01B	l <sub>1</sub> (m) Max. cable length from the last switch to the control system 0.34 mm <sup>2</sup>	l <sub>n</sub> (m) Max. cable length between the individual switches
1	10	140	-
	25	130	
	50	115	
	100	100	
	150	85	
2	10	50	10
	25		
	50		
	100		
	150		
3	10	25	10
	25		
	50		
	100		
	150		

Contact EUCHNER in the following cases:

- › If you connect more than 3 switches in series.
- › If you plan to use a different cable design (cross-section, material, etc.)

### 11.2.3. Connector assignment of Y-distributor for series connection without IO-Link communication



#### Important!

- › The switch chain must always be terminated with strapping plug 097645.
- › All guard locking solenoids are always controlled simultaneously on the use of these Y-distributors in a series connection.
- › A higher-level control system cannot detect which safety door is open or on which switch a fault has occurred with this connection technology.

Plug connector X1		Y-distributor	Plug connector X2 / X3																																			
<table border="1"> <thead> <tr> <th colspan="2">X1</th> </tr> <tr> <th>Pin</th> <th>Function</th> </tr> </thead> <tbody> <tr><td>X1.1</td><td>FI1B</td></tr> <tr><td>X1.2</td><td>UB</td></tr> <tr><td>X1.3</td><td>F01A</td></tr> <tr><td>X1.4</td><td>F01B</td></tr> <tr><td>X1.5</td><td>n.c.</td></tr> <tr><td>X1.6</td><td>FI1A</td></tr> <tr><td>X1.7</td><td>OVUB</td></tr> <tr><td>X1.8</td><td>*</td></tr> </tbody> </table>		X1		Pin	Function	X1.1	FI1B	X1.2	UB	X1.3	F01A	X1.4	F01B	X1.5	n.c.	X1.6	FI1A	X1.7	OVUB	X1.8	*	<p>097627</p>	<table border="1"> <thead> <tr> <th colspan="2">X2</th> </tr> <tr> <th>Pin</th> <th>Function</th> </tr> </thead> <tbody> <tr><td>X2.1</td><td>UB</td></tr> <tr><td>X2.2</td><td>F01A</td></tr> <tr><td>X2.3</td><td>0 V</td></tr> <tr><td>X2.4</td><td>F01B</td></tr> <tr><td>X2.5</td><td>*</td></tr> </tbody> </table>		X2		Pin	Function	X2.1	UB	X2.2	F01A	X2.3	0 V	X2.4	F01B	X2.5	*
X1																																						
Pin	Function																																					
X1.1	FI1B																																					
X1.2	UB																																					
X1.3	F01A																																					
X1.4	F01B																																					
X1.5	n.c.																																					
X1.6	FI1A																																					
X1.7	OVUB																																					
X1.8	*																																					
X2																																						
Pin	Function																																					
X2.1	UB																																					
X2.2	F01A																																					
X2.3	0 V																																					
X2.4	F01B																																					
X2.5	*																																					
<table border="1"> <thead> <tr> <th colspan="2">X1</th> </tr> <tr> <th>Pin</th> <th>Function</th> </tr> </thead> <tbody> <tr><td>X1.1</td><td>FI1B</td></tr> <tr><td>X1.2</td><td>UB</td></tr> <tr><td>X1.3</td><td>F01A</td></tr> <tr><td>X1.4</td><td>F01B</td></tr> <tr><td>X1.5</td><td>n.c.</td></tr> <tr><td>X1.6</td><td>FI1A</td></tr> <tr><td>X1.7</td><td>OVUB</td></tr> <tr><td>X1.8</td><td>*</td></tr> </tbody> </table>		X1		Pin	Function	X1.1	FI1B	X1.2	UB	X1.3	F01A	X1.4	F01B	X1.5	n.c.	X1.6	FI1A	X1.7	OVUB	X1.8	*	<p>111696 112395</p> <p>With connecting cable</p>	<table border="1"> <thead> <tr> <th colspan="2">X3</th> </tr> <tr> <th>Pin</th> <th>Function</th> </tr> </thead> <tbody> <tr><td>X3.1</td><td>UB</td></tr> <tr><td>X3.2</td><td>FI1A</td></tr> <tr><td>X3.3</td><td>0 V</td></tr> <tr><td>X3.4</td><td>FI1B</td></tr> <tr><td>X3.5</td><td>*</td></tr> </tbody> </table>		X3		Pin	Function	X3.1	UB	X3.2	FI1A	X3.3	0 V	X3.4	FI1B	X3.5	*
X1																																						
Pin	Function																																					
X1.1	FI1B																																					
X1.2	UB																																					
X1.3	F01A																																					
X1.4	F01B																																					
X1.5	n.c.																																					
X1.6	FI1A																																					
X1.7	OVUB																																					
X1.8	*																																					
X3																																						
Pin	Function																																					
X3.1	UB																																					
X3.2	FI1A																																					
X3.3	0 V																																					
X3.4	FI1B																																					
X3.5	*																																					

\* Function and compatibility are dependent on the connector assignment of the device connected.

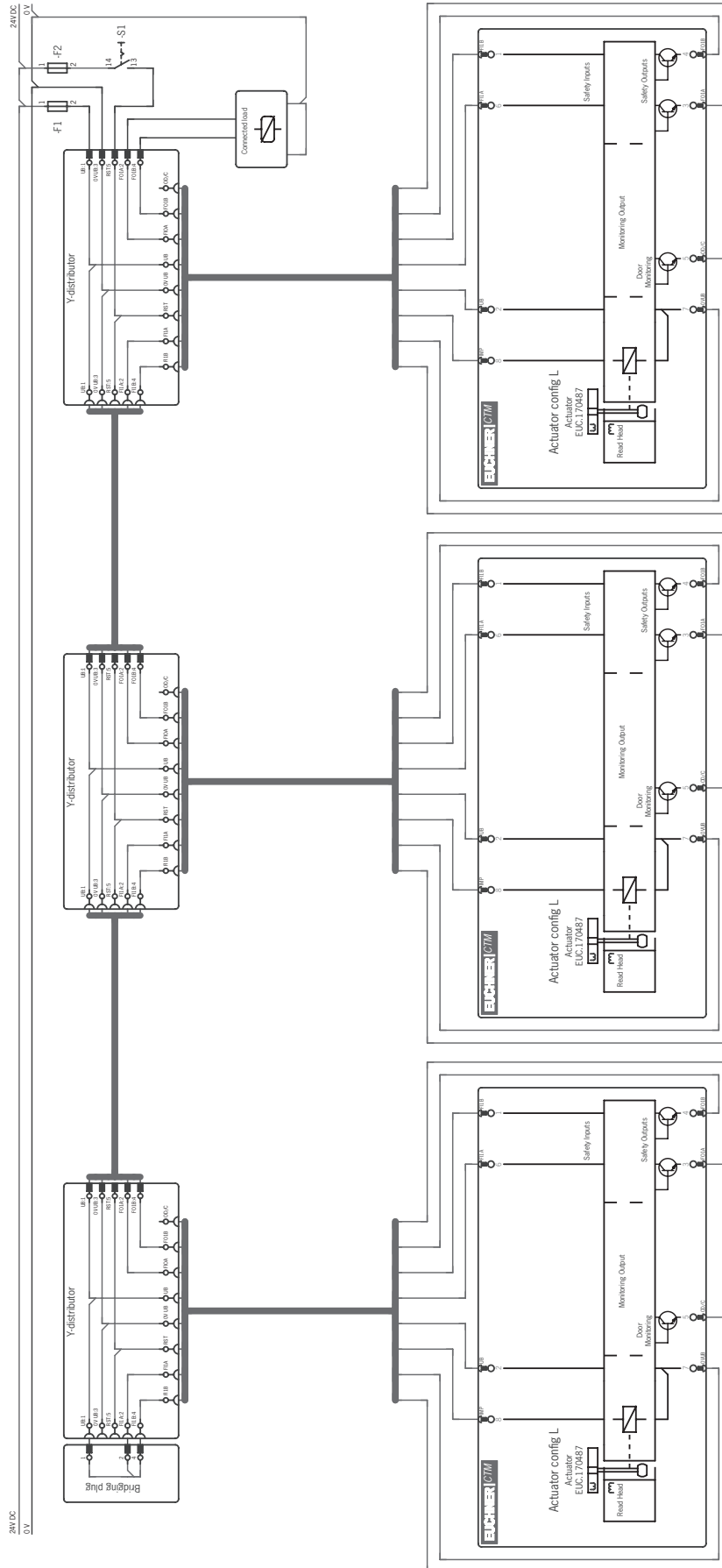

Fig. 2: Connection example for series connection with control of guard locking via control input IMP (principle of operation)

## 12. Using communication data

A BR/IO-Link Gateway is required to use the device's communication data and forward them to a higher-level bus system. The following devices are suitable:

- › GWY-CB-1-BR-IO (BR/IO-Link Gateway)
- › ESM-CB (safety relay with integrated BR/IO-Link Gateway)

### 12.1. Connection to a BR/IO-Link Gateway GWY-CB

The Gateway is an IO-Link device. Communication via IO-Link offers cyclical (process data) and acyclical (device data and events) data exchange (see chapter 12.3. *Overview of the communication data on page 24*).

The communication connection C on the device allows the diagnostic line to be connected to the Gateway. The Ox/C connection represents a non-safety-related communication channel between the Gateway and the connected devices.

IO-Link communication can be used for the following functions as well:

- › Reset for acknowledging error messages

You will find further information in the operating instructions for your BR/IO-Link Gateway.

### 12.2. Connection to a safety relay ESM-CB

The safety relay ESM-CB features an integrated BR/IO-Link Gateway. In addition to functioning as an IO-Link device (see chapter 12.1. *Connection to a BR/IO-Link Gateway GWY-CB on page 23*), the device can be used for connecting two monitored single- or dual-channel sensor circuits. The sensor circuits evaluate various signaling devices:

- › Sensor circuit S1 with short circuit detection; suitable for single- or dual-channel safety sensors
- › Sensor circuit S2, suitable for OSSD signals; short circuit detection by signaling device

When at least one sensor circuit is interrupted, the safety relay initiates the safe state. Different relay starting behaviors and various monitoring functions are possible.

The device's safety outputs FO1A and FO1B are routed to the OSSD inputs of the safety relay. The OD/C connection of the device allows the diagnostic line to be connected to the Gateway.

You will find further information in the operating instructions for your safety relay with integrated BR/IO-Link Gateway.

### 12.3. Overview of the communication data

The switch transmits both process data that are continuously transmitted to the evaluation unit (cyclical data) and data that can be polled specifically as needed (acyclical data). For further information on connection and on the communication data, refer to the operating instructions for your BR/IO-Link Gateway.

#### 12.3.1. Cyclical data (process data)

Table 2: Cyclical data (process data)

	Bit 7	Bit 6	Bit 5	Bit 4	Bit 3	Bit 2	Bit 1	Bit 0
Byte 1	OI	-	-	-	OM	-	-	OD
Byte 2	-	-	-	-	OLS	-	OL	-

Bit	Signal	Message
OI	Diagnostics	There is an error, see chapter 15.3. <i>Error messages on page 31.</i>
OM	Status	The safety outputs of the device are switched.
OD	Door position	A valid actuator is detected in the actuating range, and the guard is closed.
OLS	Locking element	The locking element is stuck, see chapter 15.3. <i>Error messages on page 31.</i>
OL	Guard locking	Guard locking is active.



### 12.3.2. Acyclical data (device data and events)

After one of the commands listed below is sent, the requested data are provided via the IO-Link Gateway. The reply message always consists of 8 bytes in big endian format.

**Example 1:** reply message in response to the command *Send device ID number/serial number*: 06 **02 77 67 00 01 17 00**

In this example, the device's ID number is **161639** and its serial number is **279**.

Byte number	Byte 0	Byte 1	Byte 2	Byte 3	Byte 4	Byte 5	Byte 6	Byte 7
Reply in hex	06	<b>02</b>	<b>77</b>	<b>67</b>	<b>00</b>	<b>01</b>	<b>17</b>	00
Description	User data length in bytes	Device ID number			Serial number			Padding data
Reply in dec	6 bytes	<b>161639</b>			<b>279</b>			-

Command		Reply	
HEX	Meaning	Number of bytes	Bit sequences (big endian format)
0x02	Send device ID number/serial number	6	Bytes 1 - 3   Device ID number
			Bytes 4 - 6   Serial number
0x03	Send version number of the device	5	Byte 1   (V)
			Bytes 2 - 4   Version number
0x05	Send number of devices in series connection	1	
0x12	Send current error code	1	
0x13	Send most recently saved error code	1	
0x14	Send size of log file	1	
0x15	Send entry from log file with index	1	
0x16	Send current actuator code	5	
0x17	Send taught-in actuator code	5	
0x18	Send disabled actuator code	5	
0x19	Send applied voltage in mV	2	
0x0F	Send number of teach-in operations, factory resets and resets for acknowledging error messages	3	Byte 1   Number of teach-in operations
			Byte 2   Number of factory resets
			Byte 3   Number of resets for acknowledging error messages
0x1A	Send current temperature in °C	1	
0x1B	Send number of door position switching cycles	3	
0x1D	Reset for acknowledging error messages <sup>1)</sup>	-	
0x1E	Factory reset	1	0x1E – Factory reset performed

1) Each BR device must be addressed individually in a chain.



For more information on these and other acyclical data, refer to the operating instructions for your BR/IO-Link Gateway.

## 13. Setup

### 13.1. Configuring device and teaching-in actuator for the first time

The device must be configured and the actuator must be allocated to the safety switch before the system forms a functional unit. During configuration, the function actuator is used to specify the monitoring of the guard locking for process protection as permanently active or as optional. As such, the selection of the actuator determines the function of the device.

Configuration and the teach-in operation occur simultaneously in the delivery state or after a factory reset.

Actuator	Function
A-FLX-B-08-A1-A1-170487 	Monitoring of guard locking for process protection is active.
A-FLX-B-09-A1-A1-170488 	Monitoring of guard locking for process protection is optional.

#### Prerequisite:

- › The device is in the delivery state. A factory reset must be performed before a preconfigured device can be reconfigured (see chapter 14. *Factory reset on page 29*).
- › The device is isolated from the operating voltage.

1. Switch on operating voltage.
  - ➔ The STATE LED flashes green quickly. The device carries out a self-test.
  - ➔ The STATE LED flashes 3 x green repeatedly. The device is in unlimited teach-in standby.
2. Insert an actuator.
  - ➔ The teach-in operation begins. The STATE LED flashes green slowly.
  - ➔ The teach-in operation ends after approx. 30 s. The STATE and DIA LEDs flash alternately green and red.
3. Switch off the operating voltage for at least 3 s.
  - ➔ The code of the actuator taught-in is activated in the safety switch. The actuator is valid.
4. Switch on operating voltage.
  - ➔ The device operates normally.

### 13.2. Teaching-in a new actuator

During a teach-in operation, the safety outputs are switched off, i.e. the system is in the safe state.

The teach-in operation starts automatically after the operating voltage is switched on. The number of possible teach-in operations is unlimited.

	<p><b>Tip!</b></p> <p>Prior to switching on, close the guard on which the actuator to be taught-in is installed. The teach-in operation starts immediately after switching on. This feature simplifies above all teach-in with series connections and on large installations.</p>
---	---

	<p><b>Important!</b></p> <ul style="list-style-type: none"> <li>› The teach-in operation can be performed only if the device does not have any internal fault.</li> <li>› Devices in the condition as supplied remain in teach-in standby state until they have successfully taught-in the first actuator. Once taught-in, switches remain in the teach-in standby state for approx. 3 min. after each switch-on.</li> </ul>
---	--



### Important!

- › The safety switch disables the code of the preceding device if teach-in is carried out for a new actuator. Teach-in is not possible again immediately for this device if a new teach-in operation is carried out. The disabled code is enabled again in the safety switch only after a third code has been taught-in.
- › The safety switch can be operated only with the last actuator taught-in.
- › If the switch detects the actuator that was most recently taught-in when in the teach-in standby state, this state is ended immediately and the switch changes to normal operation.
- › The actuator to be taught-in is not activated if it is within the actuating range for less than 30 s.
- › If only a new actuator is to be taught-in without changing the device configuration, a factory reset is not required.
- › If a new actuator is to be taught-in and the function of this actuator does not match the device configuration already taught-in, the teach-in operation is terminated and an error message output, see chapter 15.3. *Error messages on page 31.*

1. Establish teach-in standby:
  - Devices in the condition as supplied: unlimited teach-in standby after switching on.
  - Switch already taught-in: teach-in standby is available for approx. 3 min. after switching on.
- ➔ Teach-in standby indication, STATE LED flashes 3x repeatedly.
2. Insert the actuator during teach-in standby.
  - ➔ The automatic teach-in operation starts (duration approx. 30 s). The STATE LED flashes slowly during the teach-in operation. Alternate flashing of the STATE and DIA LEDs acknowledges the successful teach-in operation. Teach-in errors are indicated by the illumination of the red DIA LED and a flashing code of the green STATE LED (see chapter 15.2. *Status messages on page 30*).
3. Switch off operating voltage (min. 3 s).
  - ➔ The code of the actuator that was just taught-in is activated in the safety switch.
4. Switch on operating voltage.
  - ➔ The device operates normally.

### 13.3. Functional check



**WARNING**

- Danger of fatal injury as a result of faults in installation and the functional check.
- › Before carrying out the functional check, make sure that there are no persons in the danger area.
  - › Observe the valid accident prevention regulations.

#### 13.3.1. Mechanical function test

The actuator must slide easily into the switch. Close the guard several times to check the function.

#### 13.3.2. Electrical function test

After installation and after any fault, the safety function must be fully checked. Proceed as follows:



**If monitoring of guard locking for process protection is active:**

1. Switch on operating voltage.
    - ➔ The machine must not start automatically.
    - ➔ The safety switch carries out a self-test. The green STATE LED flashes for 5 s at 5 Hz. The green STATE LED then flashes at regular intervals.
  2. Close all guards. In case of guard locking by solenoid force: activate guard locking.
    - ➔ The machine must not start automatically. It must not be possible to open the guard.
    - ➔ The green STATE LED and the yellow LOCK LED are illuminated continuously.
  3. Enable operation in the control system.
    - ➔ It must not be possible to release guard locking as long as operation is enabled.
  4. Release guard locking if necessary and open guard.
    - ➔ The machine must switch off and it must not be possible to start it as long as the guard is open.
- Repeat steps 2 - 4 for each guard.



**If monitoring of guard locking for process protection is optional:**

1. Switch on operating voltage.
    - ➔ The machine must not start automatically.
    - ➔ The safety switch carries out a self-test. The green STATE LED flashes for 5 s at 5 Hz. The green STATE LED then flashes at regular intervals.
  2. Close all guards. As soon as the actuator is inserted into the switch, the safety outputs are switched on independent of the state of the guard locking.
    - ➔ The machine must not start automatically.
    - ➔ The green STATE LED illuminates continuously. In addition, depending on the state of the guard locking, the yellow LOCK LED illuminates permanently or is switched off permanently.
  3. Enable operation in the control system.
  4. Release guard locking if necessary and open guard.
    - ➔ The machine must switch off and it must not be possible to start it as long as the guard is open.
- Repeat steps 2 - 4 for each guard.
- Check every safety guard to ensure that deactivating the guard locking will not affect the safety function.

### 14. Factory reset

A factory reset deletes the configuration and restores the device's factory settings.

To perform a factory reset, connect the two outputs FO1A and FO1B to 0 V before connecting the operating voltage or send the command 0x1E via IO-Link communication (see chapter 12.3.2. *Acyclical data (device data and events)* on page 25).

### 15. Status and error messages

#### 15.1. LED displays

LED	Color
STATE	green
LOCK	yellow
DIA	red

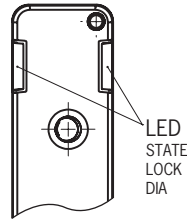

#### Important!















If you do not find the displayed device status in the following tables, this indicates an internal device fault. Contact EUCHNER.







Key to symbols			LED not illuminated
			LED illuminated
	1 x in-verse		LED illuminated, briefly goes off 1 x
	quickly		LED flashes quickly (3 Hz)
	slowly		LED flashes slowly (0.6 Hz)
	3 x		LED repeatedly flashes three times
			LEDs flash alternately
	X		Any state

## 15.2. Status messages

Operating mode	LED indicator			Safety outputs FO1A/FO1B	Guard locking signal OL	Door position signal OD	Status
	STATE green	LOCK yellow	DIA red				
Self-test	5 Hz (5 s)	○	○	off	off	off	Self-test after operating voltage is switched on.
	quickly		1 x				No communication with the BR/IO-Link Gateway.
Normal operation			○	on	on	on	If guard lock monitoring is active: door is closed and locked. The safety outputs of the preceding device in a series connection are switched on.
		○		on	off	on	If guard lock monitoring is optional: door is closed. The safety outputs of the preceding device in a series connection are switched on.
	1 x inverse	○		off	off	on	If guard lock monitoring is active: door is closed and not locked. The safety outputs of the preceding device in a series connection are switched off.
	1 x			off	off	off	Door is open.
	1 x	1 x		off	off	off	Door is open and ready for locking.
Teach-in operation	3 x	○	○	off	off	off	Device is in teach-in standby (see chapter 13.1. <i>Configuring device and teaching-in actuator for the first time on page 26</i> ).
	slowly		off		off	on	Teach-in operation. Door is closed.
	1 x →		← 1 x	X	X	Positive acknowledgment after successful teach-in operation.	
Error	1 x	depending on the error	or  1 x inverse	off	depending on the error	Error message (see chapter 15.3. <i>Error messages on page 31</i> ).	

### 15.3. Error messages

Error code via IO-Link	LED indicator			Error	Troubleshooting	Ac-knowledging errors	
	STATE green	LOCK yellow	DIA red			Opening/closing door	Reset
<b>Teach-in errors</b>							
0x1F				Actuator removed from the actuating range prior to the end of the teach-in operation.	Check whether the actuator is outside the actuating range or in the limit range.		●
0x25		○		Disabled actuator detected during the teach-in operation: The actuator was taught-in during the penultimate teach-in operation and is disabled for the current teach-in operation.	Repeat the teach-in operation with a new actuator (see chapter 13.2. <i>Teaching-in a new actuator on page 26</i> ).		●
<b>Input errors</b>							
0x2E				Different signal states at the safety inputs F11A and F11B during operation.	<ul style="list-style-type: none"> <li>› Check wiring.</li> <li>› Check preceding device in the switch chain.</li> </ul>	●	
0x30		○		Different signal states at the safety inputs F11A and F11B during the self-test.		●	
0x31 0x32	2 x			Test pulses not detected at safety input F11A or F11B during operation.		●	
0x36 0x37				Test pulses not detected at safety input F11A or F11B during the self-test.		●	
<b>Transponder/read errors</b>							
0x42		○		Invalid or faulty actuator detected during teach-in operation. <ul style="list-style-type: none"> <li>› The actuator is not intended for the current device configuration.</li> <li>› The actuator's data structure cannot be read. The actuator is defective.</li> </ul>	Repeat the teach-in operation with a valid actuator (see chapter 13.2. <i>Teaching-in a new actuator on page 26</i> ).		●
				Invalid or faulty actuator detected. <ul style="list-style-type: none"> <li>› The actuator is not intended for the current device configuration.</li> <li>› The actuator's data structure cannot be read. The actuator is defective.</li> </ul>	Remove actuator. Error is reset automatically.		
<b>Output errors</b>							
0x4C 0x4D		○		A HIGH signal is detected at safety output FO1A or FO1B during the self-test.	Check wiring.		●
0x54				The voltage level at safety outputs FO1A and FO1B during operation does not meet the requirements. External voltage might be present.		●	
<b>Environment errors</b>							
0x60				Supply voltage too high.	Decrease supply voltage.	●	
0x61		○		Supply voltage too low.	<ul style="list-style-type: none"> <li>› Increase supply voltage.</li> <li>› Check system configuration: cable length, number of devices in the switch chain.</li> </ul>	●	
0x62				Device temperature too high.	Observe the specified temperature range (see chapter 16. <i>Technical data on page 33</i> ).		●
0x63				Device temperature too low.		●	
<b>Internal fault</b>							
0x01	○	○		Internal device fault	Restart the device. On repeated occurrence, contact EUCHNER.		●

Error code via IO-Link	LED indicator			Error	Troubleshooting	Ac-knowledging errors	
	STATE green	LOCK yellow	DIA red			Opening/closing door	Reset
<b>Plausibility errors</b>							
0x89		 1 Hz		Mechanically damaged actuator detected during operation.	Check actuator and switch for damage and replace if necessary.		●
0x8C		 1 x		Guard locking was opened without active control: ‣ Auxiliary release was actuated. ‣ Internal fault	‣ Reset auxiliary release and restart the device. ‣ On repeated occurrence, contact EUCHNER.		●
0x8E	○	 1 Hz	 1 Hz	‣ Actuator detected after error 0x89	Alternatively, take one of the following measures: ‣ Interrupt voltage at control input IMP to release the guard locking. Insert the actuator into the switch head. Interrupt the operating voltage for at least 3 s. The error code is deleted, and the actuator is taught-in. ‣ Perform a factory reset and teach-in the actuator (see chapter 13.1. <i>Configuring device and teaching-in actuator for the first time on page 26</i> ).		●
<b>Other errors</b>							
0xAC	○	 2 x	 1x inverse	Guard locking cannot be activated.	Open door for at least 3 s. When closing the door again, ensure that the actuator is fully inserted.	●	

## 15.4. Acknowledging error messages

If the DIA LED flashes inversely once, the error message can be acknowledged by opening and closing the guard. If the error is still displayed afterward, a reset must be performed.

If the DIA LED is permanently illuminated, the error message can be acknowledged only by a reset.

The reset can be performed as follows.

Reset	Centrally for all devices in a chain	Each device must be addressed individually	Further information
By briefly disconnecting the power supply (at least 3 s)	●	-	-
Via the cyclical data of IO-Link communication	●	-	See operating instructions for the IO-Link Gateway
Via the acyclical data of IO-Link communication	-	●	See chapter 12.3.2. <i>Acyclical data (device data and events) on page 25</i>

Reset for acknowledging error messages does not delete the configuration.



### Important!

Contact EUCHNER if the fault display is not reset after briefly disconnecting the power supply.



### 16. Technical data



#### NOTICE

If a data sheet is available for the product, the information on the data sheet applies.

#### 16.1. Technical data for safety switch CTM-C2-BP/BR

Parameter	Value			Unit
	min.	typ.	max.	
<b>General</b>				
Material	Fluorinated rubber (FKM)			
- Seals	Reinforced thermoplastic			
- Switch housing				
Installation position	Any			
Degree of protection	IP65/IP67/IP69/IP69K <sup>1)</sup> (screwed tight with the related mating connector)			
Safety class acc. to EN IEC 61140	III			
Degree of contamination (external, acc. to EN 60947-1)	3 (industrial)			
Mechanical life	1 x 10 <sup>6</sup> operating cycles			
Ambient temperature at U <sub>B</sub> = 24 V	-20	-	+60	°C
Actuator approach speed	-	-	20	m/min.
Actuating/extraction/retention force	Device dependent, see www.euchner.com			N
Locking force F <sub>max</sub>	1,300			N
Locking force F <sub>Zh</sub>	F <sub>Zh</sub> = F <sub>max</sub> /1.3 = 1,000			N
Connection (depending on version)	1 plug connector M12, 8-pin			
Operating voltage U <sub>B</sub> (reverse polarity protected, regulated, residual ripple < 5%)	24 ± 15% (PELV)			V DC
Current consumption I <sub>UB</sub> at U <sub>B</sub> = 24 V	-	385	500	mA
The following applies to the approval acc. to UL	Operation only with UL Class 2 power supply or equivalent measures			
Switching load acc. to UL	24 V DC, Class 2			
External fuse (operating voltage U <sub>B</sub> )	0.7	-	8	A
External fuse (guard locking solenoid control input U <sub>IMP</sub> )	0.1	-	2	A
Rated insulation voltage U <sub>i</sub>	50			V
Rated impulse withstand voltage U <sub>imp</sub>	0.5			kV
Rated conditional short-circuit current	100			A
Shock and vibration resistance	Acc. to EN 60947-5-3			
EMC protection requirements	Acc. to EN 60947-5-3			
Ready delay	-	5.5	-	s
Risk time acc. to EN 60947-5-3	-	-	200	ms
Risk time acc. to EN 60947-5-3, extension for each additional device	-	-	10	ms
Turn-on time				
- Guard lock monitoring optional	-	-	100	ms
- Guard lock monitoring active	-	-	500	ms
Discrepancy time between both safety outputs acc. to EN 60947-5-3	-	-	10	ms
Test pulse duration	-	-	0.3	ms
Test pulse interval	-	-	Approx. 100	ms
<b>Safety outputs F01A/F01B</b>				
Semiconductor outputs, p-switching, short circuit-proof				
Output voltage U <sub>F01A</sub> /U <sub>F01B</sub> <sup>2)</sup>				
- HIGH U <sub>F01A</sub> /U <sub>F01B</sub>	UB - 1.5	-	UB	V DC
- LOW U <sub>F01A</sub> /U <sub>F01B</sub>	0	-	1	
Switching current per safety output	1	-	150	mA
Utilization category acc. to EN 60947-5-2	DC-13 24V 150 mA Caution: outputs must be protected with a free-wheeling diode in case of inductive loads			
Switching frequency	-	-	0.25	Hz
<b>Monitoring outputs O<sub>x</sub>/C</b>				
p-switching, short circuit-proof				
Output voltage	0.8 x UB	-	UB	V DC
Max. load	1	-	50	mA
<b>Solenoid IMP (control input of guard locking solenoid)</b>				
Input voltage				
- Guard locking not active (open)	0	-	5	V DC
- Guard locking active (closed)	20.4	-	26.4	
Solenoid current consumption I <sub>IMP</sub>				
- Guard locking active (closed)	20	-	50	mA
Connection rating at max. switching frequency	3			W
Duty cycle	100			%

Characteristics acc. to EN ISO 13849-1 and EN IEC 62061	Monitoring of the guard position	
Category	4	
Performance Level (PL)	e	
PFD <sub>b</sub>	4.11 x 10 <sup>-9</sup>	
Maximum SIL	3	
Mission time	20	years

- 1) The following applies to devices with connecting cable: In areas where high-pressure cleaners are used, ensure that the high-pressure cleaner jet does not act directly on the connecting cable or the cable entry into the device. Potential damage due to the high-pressure cleaner can result in the degree of protection IP69K no longer being achieved.  
2) Values at a switching current of 50 mA without taking into account the cable lengths.

### 16.1.1. Typical system times

Refer to the technical data for the exact values.

**Ready delay:** After switch-on, the device carries out a self-test. The system is ready for operation only after this time.

**Turn-on time of safety outputs:** The max. reaction time  $t_{on}$  is the time from the moment when the guard is locked to the moment when the safety outputs switch on.

**Risk time according to EN 60947-5-3:** The risk time is the maximum time until at least one of the safety outputs F01A or F01B switches off safely when the actuator is removed from the actuating range. This also applies if an internal or external fault occurs at this moment.

**The following applies to guard lock monitoring for process protection:** If an actuator moves outside the actuating range, the safety outputs F01A and F01B are switched off after the risk time at the latest.

If several devices are operated in a series connection, the risk time of the overall device chain will increase with each device added. Use the following calculation formula:

$$t_r = t_{r,e} + (n \times t_i)$$

$t_r$  = Total risk time

$t_{r,e}$  = Risk time for single device (see technical data)

$t_i$  = Risk time extension per device

$n$  = Number of additional devices (total number -1)

**Discrepancy time:** The safety outputs F01A and F01B switch with a slight time offset. They have the same signal state no later than after the discrepancy time.

**Test pulses at the safety outputs:** The device generates its own test pulses on the safety outputs F01A and F01B. A downstream control system must tolerate these test pulses.

This can usually be set up in the control systems by parameter assignment. If parameter assignment is not possible for your control system or if shorter test pulses are required, contact the EUCHNER support team.

The test pulses are output only if the safety outputs are switched on.

### 16.2. Radio frequency approvals

**FCC ID: 2AJ58-07**

**IC: 22052-07**

#### FCC/IC-Requirements

This device complies with part 15 of the FCC Rules and with Industry Canada's licence-exempt RSSs. Operation is subject to the following two conditions:

- 1) This device may not cause harmful interference, and
- 2) this device must accept any interference received, including interference that may cause undesired operation.

Changes or modifications not expressly approved by the party responsible for compliance could void the user's authority to operate the equipment.

NOTE: This equipment has been tested and found to comply with the limits for a Class A digital device, pursuant to part 15 of the FCC Rules. These limits are designed to provide reasonable protection against harmful interference when the equipment is operated in a commercial environment. This equipment generates, uses, and can radiate radio frequency energy and, if not installed and used in accordance with the instruction manual, may cause harmful interference to radio communications.

Operation of this equipment in a residential area is likely to cause harmful interference in which case the user will be required to correct the interference at his own expense.

Le présent appareil est conforme aux CNR d'Industrie Canada applicables aux appareils radio exempts de licence. L'exploitation est autorisée aux deux conditions suivantes :

- (1) l'appareil ne doit pas produire de brouillage, et
- (2) l'utilisateur de l'appareil doit accepter tout brouillage radioélectrique subi, même si le brouillage est susceptible d'en compromettre le fonctionnement.

#### Supplier's Declaration of Conformity

##### 47 CFR § 2.1077 Compliance Information

#### Unique Identifier:

CTM-LBI-BR series  
CTM-IBI-BR series  
CTM-CBI-BR series  
CTM-L2-BR series  
CTM-I2-BR series  
CTM-C2-BR series  
CTM-LBI-BP series  
CTM-IBI-BP series  
CTM-CBI-BP series  
CTM-L2-BP series  
CTM-I2-BP series  
CTM-C2-BP series  
CTM-L2-AS1B series  
CTM-I2-AS1B series  
CTM-LBI-AS1B series  
CTM-IBI-AS1B series

#### Responsible Party – U.S. Contact Information

##### **EUCHNER USA Inc.**

1860 Jarvis Avenue  
Elk Grove Village, Illinois 60007

info(at)euchner-usa.com  
<http://www.euchner-usa.com>

16.3. Dimension drawing for safety switch CTM...

Necessary minimum travel + perm. overtravel

Actuator	Length (L)	Necessary minimum travel (h <sub>1</sub> ) + permissible overtravel (h <sub>2</sub> )	Total travel (t)
A-BA1-...	35	21 + 2	56
A-BA5-...	37	21 + 2	58

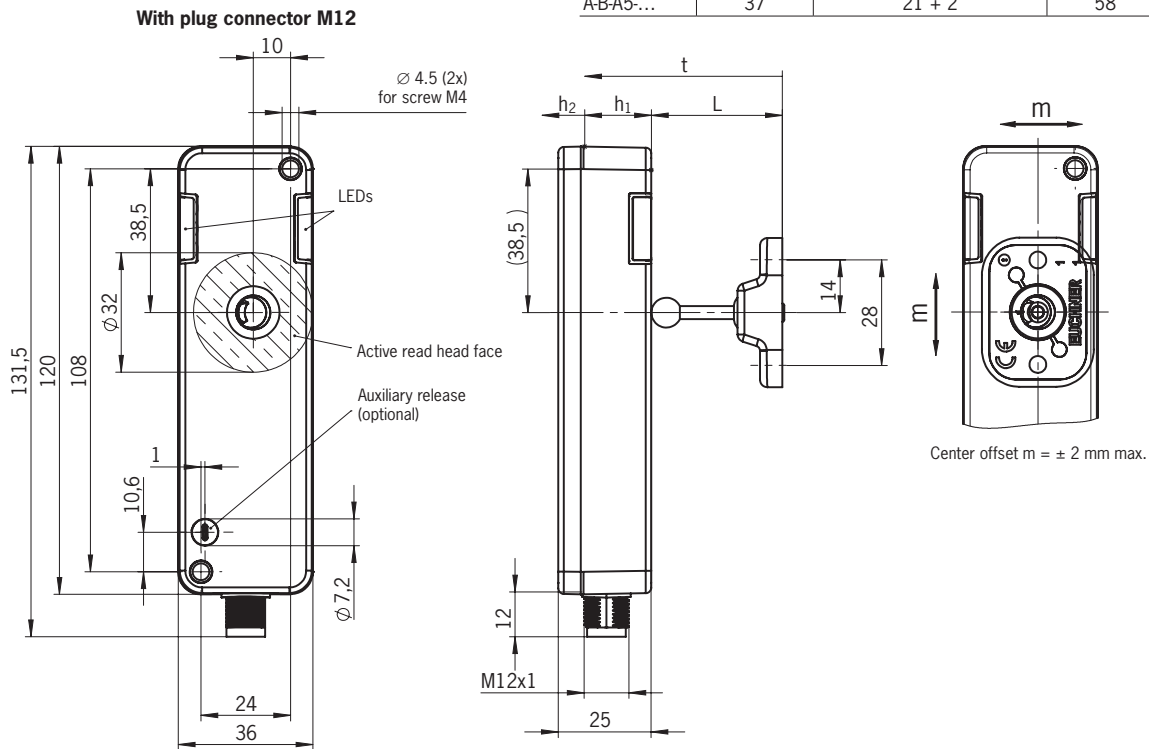

With connecting cable, 8-core

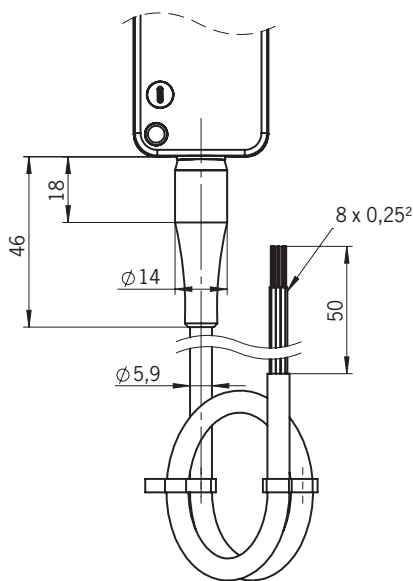

Min. door radius [mm]

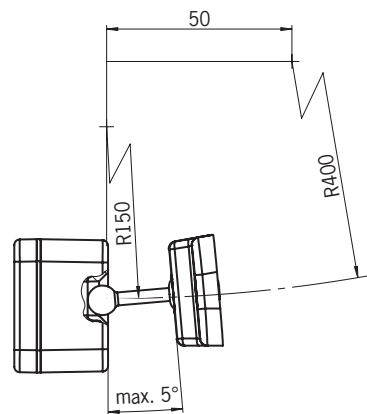

### 16.4. Technical data for actuator A-FLX-B-0.-A1-A1-...

Parameter	Value			Unit
	min.	typ.	max.	
Material				
- Housing	Ultradur black			
- Ball holder	Stainless steel			
- Elastomer	Fluorinated rubber (FKM)			
Resistance	Resistant to chemicals and oil			
Food safe	DIN EN 1672-2, EN ISO 14159, PAH category 3			
Ambient temperature	-20	-	+60	°C
Degree of protection	IP65/IP67/IP69/IP69K			
Mechanical life	1 x 10 <sup>6</sup>			
Locking force, max.	1,300			N
Locking force F <sub>Zh</sub>	1,000			N
Installation position	Any			
Overtravel	2			mm
Power supply	Inductive via read head			

#### 16.4.1. Dimension drawing for actuator A-FLX-B-0.-A1-A1-...

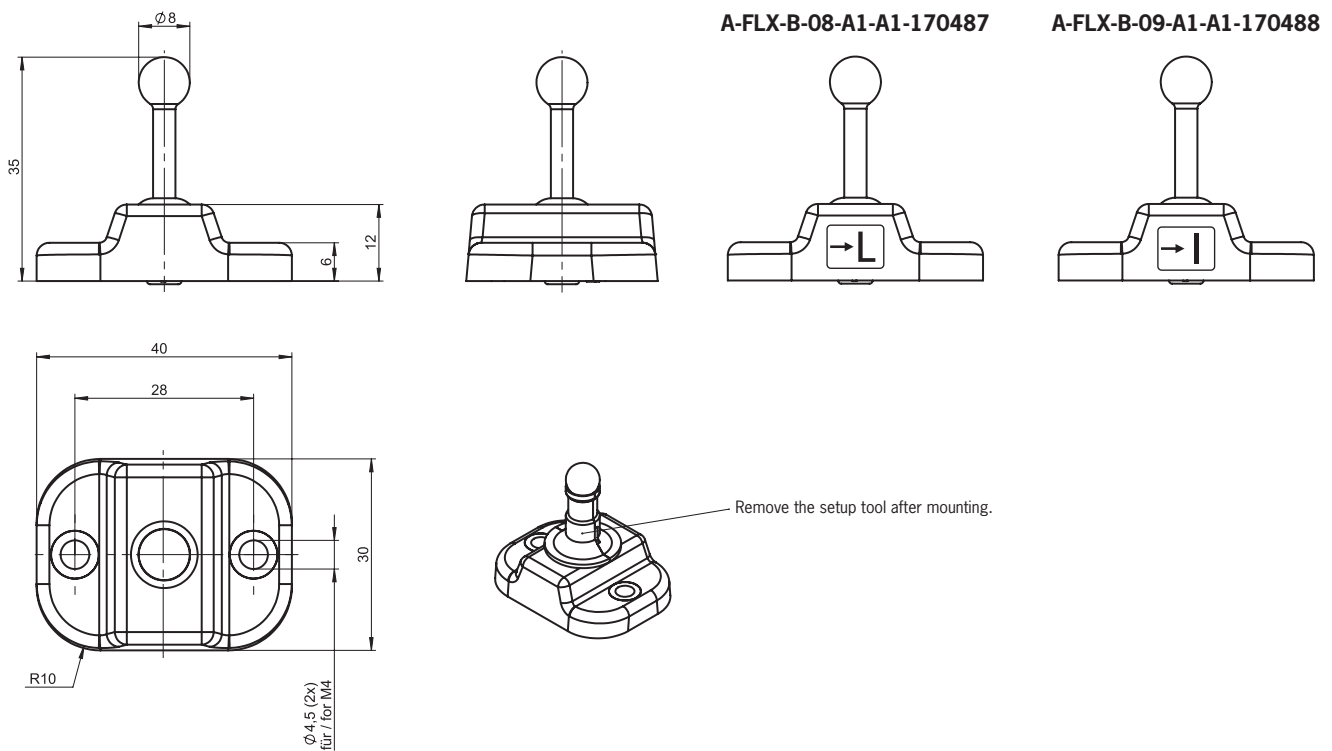

#### NOTICE

- › The actuator includes two non-removable safety screws.
- › Remove the setup tool after mounting the safety switch and actuator.

## 17. Ordering information and accessories



**Tip!**

Suitable accessories, e.g. cables or assembly material, can be found at [www.euchner.com](http://www.euchner.com). To order, enter the order number of your item in the search box and open the item view. Accessories that can be combined with the item are listed in *Accessories*.

## 18. Inspection and service



**WARNING**

Danger of severe injuries due to the loss of the safety function.

- › If damage or wear is found, the complete switch and actuator assembly must be replaced. Replacement of individual parts or assemblies is not permitted
- › Check the device for proper function at regular intervals and after every fault. For information about possible time intervals, refer to EN ISO 14119:2013, section 8.2.

Regular inspection of the following is necessary to ensure trouble-free long-term operation:

- › Check the switching function (see chapter 13.3. *Functional check on page 28*)
- › Check all additional functions (e.g. escape release, lockout bar, etc.)
- › Check the secure mounting of the devices and the connections
- › Check for contamination

No servicing is required. Repairs to the device are only allowed to be made by EUCHNER.



**NOTICE**

The year of manufacture is given in the laser marking at the bottom right corner. The current version number in the format (V X.X.X) can also be found on the device.

## 19. Service

If servicing is required, please contact:

EUCHNER GmbH + Co. KG  
Kohlhammerstraße 16  
70771 Leinfelden-Echterdingen  
Germany

**Service telephone:**  
+49 711 7597-500

**E-mail:**  
[support@euchner.de](mailto:support@euchner.de)

**Internet:**  
[www.euchner.com](http://www.euchner.com)

## 20. Declaration of conformity

The product complies with the requirements according to Machinery Directive 2006/42/EC.

The EU declaration of conformity can be found at [www.euchner.com](http://www.euchner.com). Enter the order number of your device in the search box. The document is available under *Downloads*.



EUCHNER GmbH + Co. KG  
Kohlhammerstraße 16  
70771 Leinfelden-Echterdingen  
Germany  
info@euchner.de  
www.euchner.com

Edition:  
MAN20001574-04-10/24  
Title:  
Operating Instructions Transponder-Coded Safety Switch  
CTM-C2-BP/BR-FLX  
(translation of the original operating instructions)  
Copyright:  
© EUCHNER GmbH + Co. KG, 10/2024

Subject to technical modifications; no responsibility is accepted for the accuracy of this information.