

EUCHNER

Operating Instructions

**Transponder-Coded Safety Switch with Guard Locking for Process Protection
CTS-C2-BP/BR-FLX High/Low Coding Level**

EN

Contents

1.	About this document	4
1.1.	Scope.....	4
1.2.	Target group	4
1.3.	Key to symbols.....	4
1.4.	Supplementary documents	4
2.	Correct use	5
3.	Description of the safety function	7
4.	Exclusion of liability and warranty	8
5.	General safety precautions	8
6.	Function	9
6.1.	Monitoring of the guard locking for process protection	9
6.2.	Monitoring outputs/status bits	9
6.2.1.	Guard locking signal OL.....	9
6.2.2.	Door position 1 signal OD.....	9
6.2.3.	Door position 2 signal OT	9
6.2.4.	Diagnostic signal OI	10
6.2.5.	Escape release signal OER	10
6.2.6.	Status signal OM.....	10
6.2.7.	Locking element signal OLS.....	10
6.2.8.	Communication connection C.....	10
6.3.	Guard locking for process protection.....	10
6.4.	Switching states	11
7.	Manual release	12
7.1.	Auxiliary release.....	12
7.1.1.	Actuating auxiliary release	12
7.2.	Escape release.....	13
7.2.1.	Actuating escape release	13
8.	Mounting	14
9.	Electrical connection	17
9.1.	Notes about c(UL)us.....	18
9.2.	Safety in case of faults.....	18
9.3.	Fuse protection for power supply	18
9.4.	Requirements for connecting cables.....	19
9.5.	Connector assignment safety switch CTS-...-AB-... with plug connectors 2 x M12.....	19
9.6.	Connector assignment safety switch CTS-...-SA-... with plug connector M12, 8-pin.....	20
9.7.	Notes on operation with safe control systems.....	20
9.8.	Connection without and with IO-Link communication.....	20
9.8.1.	Connection without IO-Link communication	20
9.8.2.	Connection with IO-Link communication.....	20

10.	Connection of a single CTS-C2-BP/BR-FLX (separate operation)	21
11.	Connection of several devices in a chain (series connection)	22
11.1.	Series connection with wiring in the control cabinet	22
11.2.	Series connection with Y-distributors	22
11.2.1.	Maximum cable lengths with BR switch chains	23
11.2.2.	Determining cable lengths using the example table	23
11.2.3.	Connector assignment of Y-distributor for series connection without IO-Link communication	24
11.2.4.	Connector assignment of Y-distributor for series connection with IO-Link communication	26
12.	Using communication data	27
12.1.	Connection to a BR/IO-Link Gateway GWY-CB	27
12.2.	Connection to a safety relay ESM-CB	27
12.3.	Overview of the communication data	28
12.3.1.	Cyclical data (process data)	28
12.3.2.	Acyclical data (device data and events)	28
13.	Setup	30
13.1.	Configuring device and teaching-in actuator for the first time	30
13.2.	Teaching-in new actuator (only for evaluation of the actuator with a high coding level)	31
13.3.	Functional check	32
13.3.1.	Mechanical function test	32
13.3.2.	Electrical function test	32
14.	Factory reset	33
15.	Status and error messages	33
15.1.	LED displays	33
15.2.	Status messages	34
15.3.	Error messages	35
15.4.	Acknowledging error messages	36
16.	Technical data	37
16.1.	Technical data for safety switch CTS-C2-BP/BR-FLX	37
16.1.1.	Typical system times	39
16.2.	Radio frequency approvals	40
16.3.	Dimension drawing for safety switch CTS	41
16.4.	Technical data for actuator A-FLX-D-0.-	42
16.4.1.	Dimension drawing for actuator A-FLX-D-0.-	42
17.	Ordering information and accessories	43
18.	Inspection and service	43
19.	Service	43
20.	Declaration of conformity	43

1. About this document

1.1. Scope

These operating instructions apply to all CTS-C2-BP/BR-FLX... of version V2.0.X. These operating instructions, the document *Safety information* and any available data sheet form the complete user information for your device.

1.2. Target group

Design engineers and installation planners for safety devices on machines, as well as setup and servicing staff possessing special expertise in handling safety components.

1.3. Key to symbols

Symbol/depiction	Meaning
	Monitoring the position of the guard and active monitoring of the guard locking for process protection, high coding level
	Monitoring the position of the guard and active monitoring of the guard locking for process protection, low coding level
	Monitoring the position of the guard and optional monitoring of the guard locking for process protection, high coding level
	Monitoring the position of the guard and optional monitoring of the guard locking for process protection, low coding level
	Printed document
	Document is available for download at www.euchner.com
 DANGER WARNING CAUTION	Safety precautions Danger of death or severe injuries Warning about possible injuries Caution slight injuries possible
 NOTICE Important!	Notice about possible device damage Important information
Tip	Useful information

1.4. Supplementary documents

The overall documentation for this device consists of the following documents:

Document title (document number)	Contents	
Safety information (2525460)	Basic safety information	
Operating instructions (MAN20001531)	(this document)	
Declaration of conformity	Declaration of conformity	
Possibly available data sheet	Item-specific information about deviations or additions	
 Important!	Always read all documents to gain a complete overview of safe installation, setup and use of the device. The documents can be downloaded from www.euchner.com . For this purpose enter the doc. no. in the search box.	

2. Correct use

Safety switches series CTS-C2-BP/BR-FLX are interlocking devices with guard locking solenoid (type 4) for process protection without safe guard locking monitoring. The device complies with the requirements according to EN 60947-5-3.

The device can be configured with the aid of a function actuator. Depending on the function actuator taught-in, the monitoring of the guard locking for process protection is permanently active or available as an additional option and the evaluation of the actuator code has a high or low coding level.

Table 1: System components

Safety switch	Function actuator			
	Monitoring of the guard locking for process protection			
	Active	Optional	Active	Optional
	High coding level	High coding level	Low coding level	Low coding level
	→ L + HC	→ I + HC	→ L + LC	→ I + LC
CTS-C2-BP/BR-FLX...	A-FLX-D-0C-167919	A-FLX-D-0D-169044	A-FLX-D-0E-169045	A-FLX-D-0F-169046

→ L + ... The following applies to active guard locking for process protection:

In combination with a movable guard and the machine control, this safety component prevents dangerous machine functions from occurring while the guard is open. A stop command is triggered if the guard is opened during the dangerous machine function or the guard locking is released.

This means:

- Starting commands that cause a dangerous machine function must become active only when the guard is closed and locked.
- Opening the guard must trigger a stop command.
- Closing and locking a guard must not cause automatic starting of a dangerous machine function. A separate start command must be issued. For exceptions, refer to EN ISO 12100 or relevant C-standards.

→ I + ... The following applies to optional monitoring of guard locking for process protection:

In combination with a movable guard and the machine control, this safety component prevents dangerous machine functions from occurring while the guard is open. A stop command is triggered if the guard is opened during the dangerous machine function.

This means:

- Starting commands that cause a dangerous machine function must become active only when the guard is closed.
- Opening the guard must trigger a stop command.
- Closing a guard must not cause automatic starting of a dangerous machine function. A separate start command must be issued. For exceptions, refer to EN ISO 12100 or relevant C-standards.

→...+ HC The following applies to evaluation of the actuator code with high coding level:

- The actuator must be assigned to the safety switch by a teach-in operation so that it is detected by the system. This unambiguous assignment ensures a particularly high level of protection against tampering. The system thus possesses a high coding level.

→...+ LC The following applies to evaluation of the actuator code with low coding level:

- With the low coding level a specific code is not requested but instead it is only checked whether the actuator is of a type that can be detected by the system. There is no exact comparison of the actuator code with the taught-in code in the safety switch. The system possesses a low coding level.

Before the device is used, a risk assessment must be performed on the machine, e.g. in accordance with the following standards:

- › EN ISO 13849-1
- › EN ISO 12100
- › IEC 62061

Correct use includes observing the relevant requirements for installation and operation, particularly based on the following standards:

- › EN ISO 13849-1
- › EN ISO 14119
- › EN 60204-1

The safety switch is allowed to be operated only in conjunction with the intended EUCHNER actuators and the related connection components from EUCHNER. If different actuators or other connection components are used, EUCHNER provides no warranty for safe function.

Safety switches in the version CTS-...-BR can be integrated into a BR device chain. Connection of several devices in a BR switch chain is permitted only using devices intended for series connection in a BR switch chain. Check this in the specifications of the device in question.



Important!

- › The user is responsible for the proper integration of the device into a safe overall system. For this purpose, the overall system must be validated, e.g. in accordance with EN ISO 13849-1.
- › It is only allowed to use components that are permissible according to *Table 1: System components*.

3. Description of the safety function

Devices from this series feature the following safety functions:

Monitoring of the position of the guard (interlocking device according to EN ISO 14119)

- › Safety function: the safety outputs are switched off when the guard is open (see chapter 6. *Function on page 9*).
- › Safety characteristics: category, Performance Level, PFH_D (see chapter 16. *Technical data on page 37*).

The following additionally applies in a BR series connection:

- › The safety outputs are switched on only when the device receives a corresponding signal from its predecessor in the chain.



NOTICE

You can regard the complete BR device chain as one subsystem during calculation. The following calculation method applies to the PFH_D value:

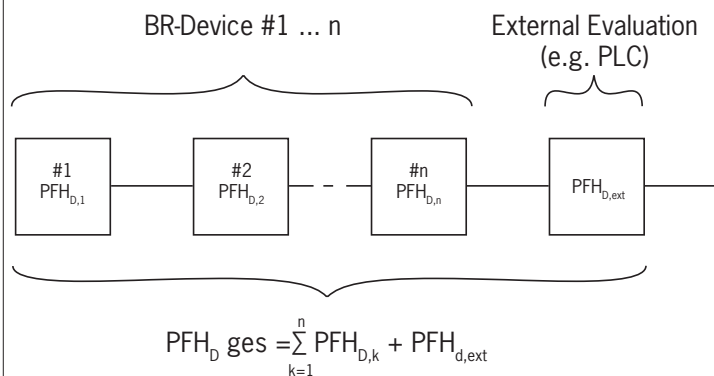

4. Exclusion of liability and warranty

In case of failure to comply with the conditions for correct use stated above, or if the safety regulations are not followed, or if any servicing is not performed as required, liability will be excluded and the warranty void.

5. General safety precautions

Safety switches fulfill personnel protection functions. Incorrect installation or tampering can lead to fatal injuries to personnel.

Check the safe function of the guard particularly

- › after any setup work
- › after the replacement of a system component
- › after an extended period without use
- › after every fault
- › after any reconfiguration of the device

Independent of these checks, the safe function of the guard should be checked at suitable intervals as part of the maintenance schedule.



WARNING

Danger to life due to improper installation or due to bypassing (tampering). Safety components fulfill a personnel protection function.

- › Safety components must not be bypassed, turned away, removed or otherwise rendered ineffective. On this topic pay attention in particular to the measures for reducing the possibility of bypassing according to EN ISO 14119:2013, section 7.
- › The switching operation must be triggered only by actuators designated for this purpose.
- › Prevent bypassing by means of replacement actuators (only for low coding level evaluation). For this purpose, restrict access to actuators and to keys for releases, for example.
- › Make sure the guard cannot be closed unintentionally, e.g. during servicing. For this purpose, a lockout bar can be used, for instance.
- › Mounting, electrical connection and setup only by authorized personnel possessing the following knowledge:
 - specialist knowledge in handling safety components
 - knowledge about the applicable EMC regulations
 - knowledge about the applicable regulations on operational safety and accident prevention.



NOTICE

Risk of damage

- › The guard locking function can no longer be ensured if an actuator is broken. Opening the door will immediately switch off the safety outputs. Regularly check the actuator for mechanical damage.



Important!

Prior to use, read the operating instructions and keep these in a safe place. Ensure the operating instructions are always available during mounting, setup and servicing. You can download the operating instructions from www.euchner.com.

6. Function

The device monitors the position of movable guards.

The system consists of the following components: coded actuator (transponder) and switch.

The coding level of the system depends on the configuration of the device (see chapter 13.1. *Configuring device and teaching-in actuator for the first time on page 30*).

When the guard is closed, the actuator is moved into the safety switch. When the operating distances are reached, power is supplied to the actuator by the switch and data are transferred.

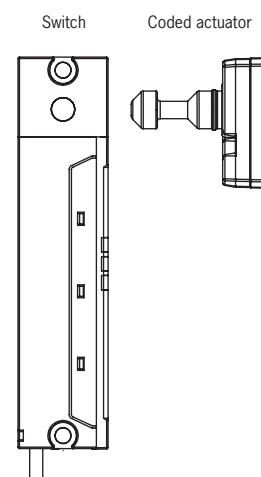

The door position 1 signal OD is set if a permissible code is detected. Guard locking is activated automatically if power is present at the guard locking solenoid. The switching conditions for the safety outputs are dependent on the configuration of the monitoring of the guard locking for process protection (see chapter 6.4. *Switching states on page 11*).

If there is a fault in the safety switch, the safety outputs are switched off and the DIA LED illuminates or flashes red (see chapter 15.3. *Error messages on page 35*). The occurrence of faults is detected at the latest on the next demand to close the safety outputs (e.g. on starting).

6.1. Monitoring of the guard locking for process protection

The device is configured with the aid of the function actuator. Depending on the function actuator taught-in, the monitoring of the guard locking for process protection is permanently active or available as an additional option. Further information about the possible settings is available in chapter 13.1. *Configuring device and teaching-in actuator for the first time on page 30*.

The following applies to active guard locking for process protection:

→ L + ... All versions feature two safe outputs for monitoring the guard locking for process protection. The safety outputs FO1A and FO1B are switched off and the guard locking signal OL is cleared when guard locking is released.

The following applies to optional monitoring of guard locking for process protection:

→ I + ... All versions feature two safe outputs for monitoring the door position as well as the status signal OL for monitoring the guard locking for process protection; this signal can be evaluated optionally. The safety outputs FO1A and FO1B are switched off and the door position 1 signal OD is cleared when the guard is opened.

6.2. Monitoring outputs/status bits

Depending on version, the signals listed in the following are available as a status bit or at the monitoring output. The status bits are evaluated via the BR/IO-Link Gateway. Please refer to the corresponding data sheet for further information.

6.2.1. Guard locking signal OL

The guard locking signal is present if the guard locking is active.

6.2.2. Door position 1 signal OD

The door position 1 signal is sent as soon as the actuator is inserted into the switch head (state: guard closed and not locked). The signal is also present if the guard locking is active.

6.2.3. Door position 2 signal OT

The door position 2 signal is present when the actuator is completely inserted into the switch head and the guard locking can be activated. In normal ambient conditions, the signal OT is sent after the signal OD as an additional door monitoring contact. The signal is also present if the guard locking is active (see chapter 6.4. *Switching states on page 11*).

6.2.4. Diagnostic signal OI

The diagnostic signal is present if there is an error (switch-on condition as for DIA LED).

6.2.5. Escape release signal OER

The escape release signal is present when the device was released manually or when activation of guard locking is prevented by manual release (see chapter 7. *Manual release on page 12*). The signal is reset when the state of guard locking control matches the guard locking state again.

6.2.6. Status signal OM

The status signal is present if the device's safety outputs are switched.

6.2.7. Locking element signal OLS

The locking element signal is present if the locking element is stuck and guard locking cannot be released. The signal is reset as soon as the actuator is no longer under tensile stress or the locking element is no longer blocked.

6.2.8. Communication connection C

A monitoring output with the suffix C has the additional function of providing a communication connection to a BR/IO-Link Gateway. The switch delivers cyclical and acyclical data. You will find an overview of the communication data in chapter 12. *Using communication data on page 27*.

If no BR/IO-Link Gateway is connected, this output behaves like a monitoring output.

6.3. Guard locking for process protection

(guard locking actuated by power-ON and released by spring force)



Important!

Malfunctions due to incorrect use.

- › The actuator must not be under tensile stress during release.
- › The guard locking is activated only if, in addition to the power at the guard locking solenoid, the electronics operating voltage is applied to the device.

The magnetically actuated guard locking operates in accordance with the open-circuit current principle. If the voltage is interrupted at the solenoid, the guard locking is released and the guard can be opened directly.

The guard can be opened as long as no power is applied to the guard locking solenoid or there is no electronics operating voltage at the device.





If power is applied to the guard locking solenoid and the actuator is completely inserted, the guard locking pin is held in the extended position and the guard is locked.

Activating guard locking: close guard; apply power to the solenoid and apply the electronics operating voltage.

Releasing guard locking: disconnect power from the solenoid or disconnect the electronics operating voltage.

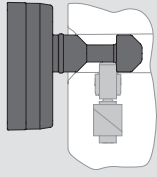
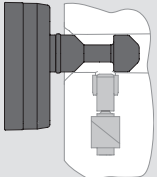
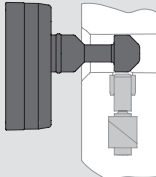
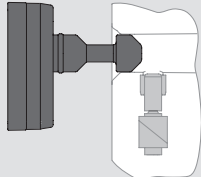
6.4. Switching states

The detailed switching states for your switch can be found in chapter 15. *Status and error messages on page 33.* All safety outputs, signals and display LEDs are described there.

	Guard closed and locked	Guard closed and not locked, ready for locking	Guard closed and not locked	Guard open		
						
Power at the guard locking solenoid	on	off	off	irrelevant		
Safety outputs F01A and F01B	on	off 	on 	off 	on 	off
Guard locking signal OL	on	off	off	off		
Door position 1 signal OD	on	on	on	off		
Door position 2 signal OT	on	on	off	off		

7. Manual release

Some situations require the guard locking to be released manually (e.g. malfunctions or an emergency). A function test must be performed after release.

More information on this topic can be found in the standard EN ISO 14119:2013, section 5.7.5.1. The device can feature the following release functions:

7.1. Auxiliary release

If malfunctions occur, the guard locking can be released with the auxiliary release irrespective of the state of the solenoid.

	<p>Important!</p> <ul style="list-style-type: none"> › The actuator must not be under tensile stress during manual release. › To prevent tampering, the auxiliary release must be sealed with sealing lacquer, for example, before the switch is set up. › Loss of the release function due to mounting errors or damage during mounting. › Check the release function every time after mounting. › The auxiliary release is not a safety function. › The correct function must be checked at regular intervals. › Observe the notes on any available data sheets.
---	--

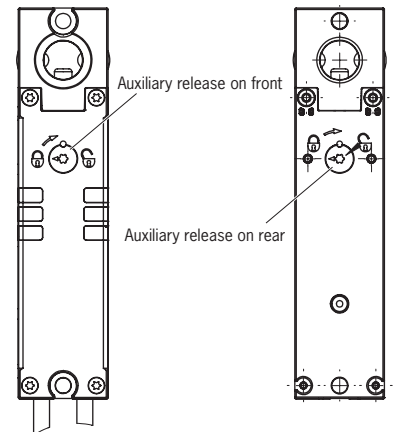

7.1.1. Actuating auxiliary release

1. Remove seal or make a hole.
2. Using a TX15 screwdriver, turn the auxiliary release to  in the direction of the arrow.

➔ If the guard locking was activated, it is unlocked.

 **The following applies to active guard locking for process protection:**

- ➔ The guard locking signal OL and the safety outputs are switched off.

 **The following applies to optional monitoring of guard locking for process protection:**

- ➔ The guard locking signal OL is switched off.

➔ The STATE LED flashes alternately white/orange slowly.
The LOCK LED flashes orange slowly.

3. Using a screwdriver, turn the auxiliary release to  in the opposite direction to the arrow to reset.

4. Seal with sealing lacquer.

5. Close guard or disconnect voltage from the solenoid.

➔ The device operates normally again.

6. Check correct function of the device.

7.2. Escape release

The escape release can be retrofitted.

The escape release permits opening of a locked guard from the danger area without tools (see chapter 16.3. *Dimension drawing for safety switch CTS on page 41*).



Important!

- › It must be possible to actuate the escape release manually from inside the protected area without tools.
- › It must not be possible to reach the escape release from the outside.
- › The actuator must not be under tensile stress during manual release.
- › The correct function must be checked at regular intervals.
- › The escape release is supplied in the actuated state. Before mounting, the escape release must be unlocked. Observe the notes in the assembly instructions for the escape release.
- › If extension pieces are used, the guide sleeve supplied must be used.
- › Loss of the release function due to mounting errors or damage during mounting.
- › Check the release function every time after mounting.
- › The escape release meets the requirements of Category B according to EN ISO 13849-1.

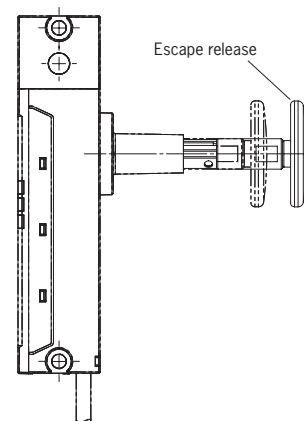

7.2.1. Actuating escape release

1. Press the red release knob to the end stop.

➔ If the guard locking was activated, it is unlocked.



The following applies to active guard locking for process protection:

➔ The guard locking signal OL and the safety outputs are switched off.



The following applies to optional monitoring of guard locking for process protection:

➔ The guard locking signal OL is switched off.

➔ The STATE LED flashes alternately white/orange slowly.
The LOCK LED flashes orange slowly.

2. Pull out the escape release knob to reset the escape release.

3. Close guard or disconnect voltage from the solenoid.

➔ The device operates normally again.

4. Check correct function of the device.

8. Mounting



CAUTION

Safety switches must not be bypassed (bridging of contacts), turned away, removed or otherwise rendered ineffective.

- Observe EN ISO 14119:2013, section 7, for information about reducing the possibilities for bypassing an interlocking device.



NOTICE

Risk of damage to equipment and malfunctions as a result of incorrect installation.

- Safety switches and actuators must not be used as an end stop.
- Observe EN ISO 14119:2014, sections 5.2 and 5.3, for information about mounting the safety switch and the actuator. The following specifications must be observed:
 - Mounting with screws of property class 8.8 or higher.
 - The minimum screw diameter is 5 mm.
 - Secure the fixing material against loosening (e.g. by means of medium-strength positive screw locking).
- Protect the switch against damage, as well as against penetrating foreign objects such as swarf, sand and blasting shot, etc.
- Observe the min. door radii (see chapter 16.4.1. *Dimension drawing for actuator A-FLX-D-0-...* on page 42).
- Observe the maximum permissible inclination angles between switch and actuator (see Fig. 4).
- Observe the tightening torque for fastening the switch and the actuator (see Fig. 3):
 - Actuator: 6 Nm
 - Switch head: 6 Nm
 - Switch housing: 3 Nm
- Actuator and safety switch must be mounted such that the actuator is perpendicularly and completely inserted into the switch when the guard is closed (see Fig. 2). The guard locking function is not assured if installation is incorrect.
- The auxiliary release must be sealed before setup, e.g. with sealing lacquer.
- If the escape release is used, the following points must be observed:
 - The escape release is supplied in the actuated state. Before mounting, the escape release must be unlocked. Observe the notes in the assembly instructions for the escape release.
 - Before mounting the escape release on a profile or if extension pieces are used, the pushbutton must be removed. It must then be re-fitted and tightened with a tightening torque of 0.6 Nm.
 - If extension pieces are used, the guide sleeve supplied must be used.
- When mounting several safety switches, observe the stipulated minimum distance to avoid mutual interference.

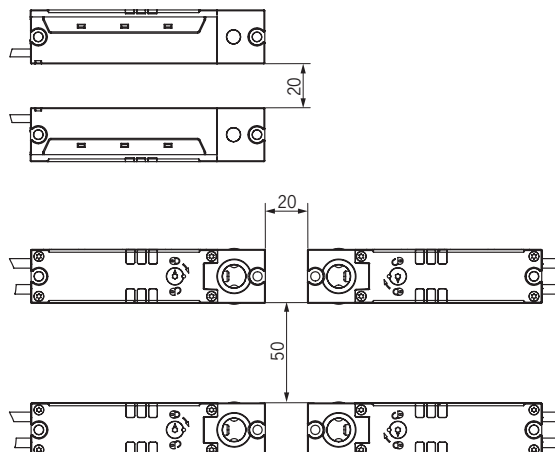

→ | + ... The following applies to optional monitoring of guard locking for process protection:



Important!

- From the assured release distance S_{ar} , the safety outputs are safely shut down. To achieve the assured release distance S_{ar} the actuator must be pulled completely out of the switch head.
- To achieve the assured operating distances S_{ao} the actuator must be inserted completely into the switch head.

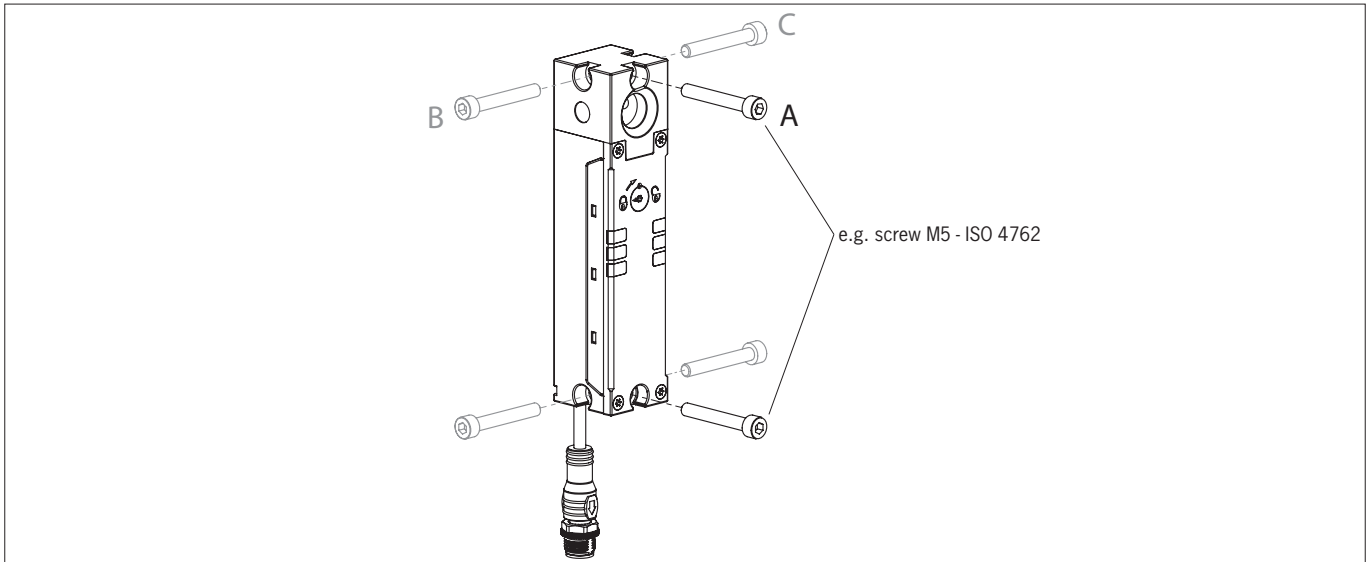

Fig. 1: Front (A) and side (B, C) mounting

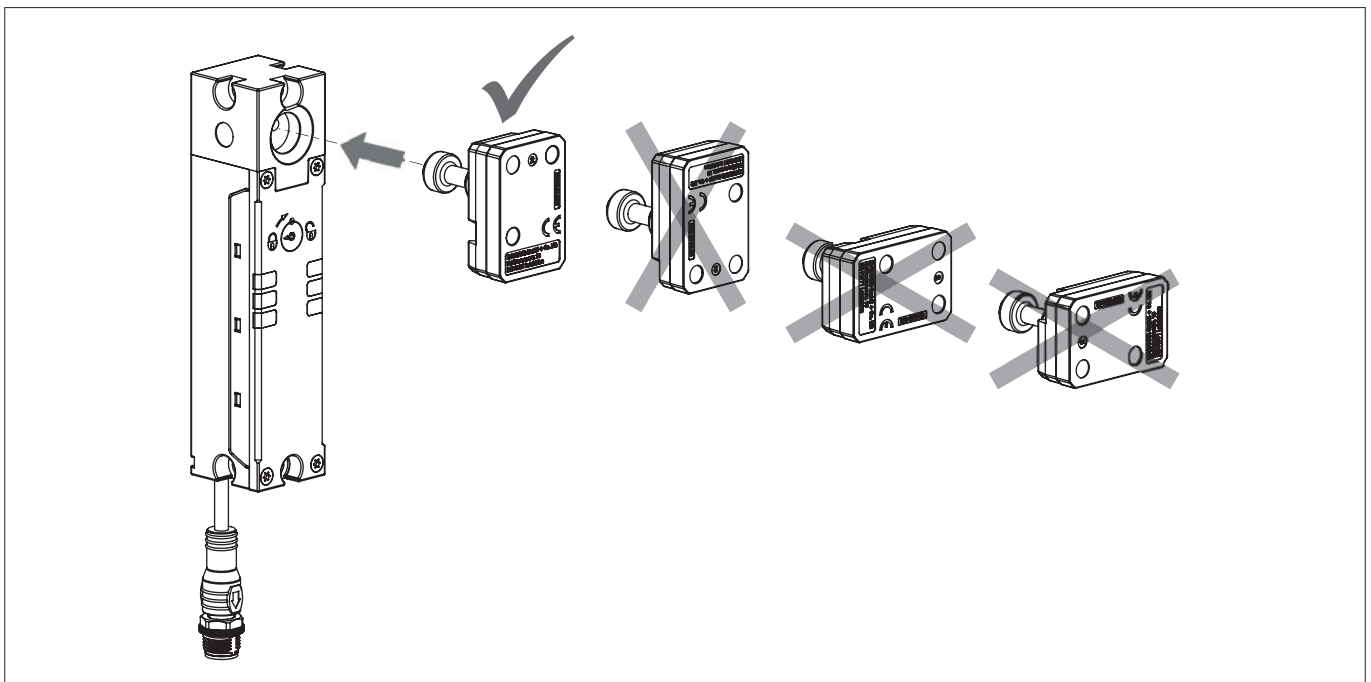

Fig. 2: Actuator alignment

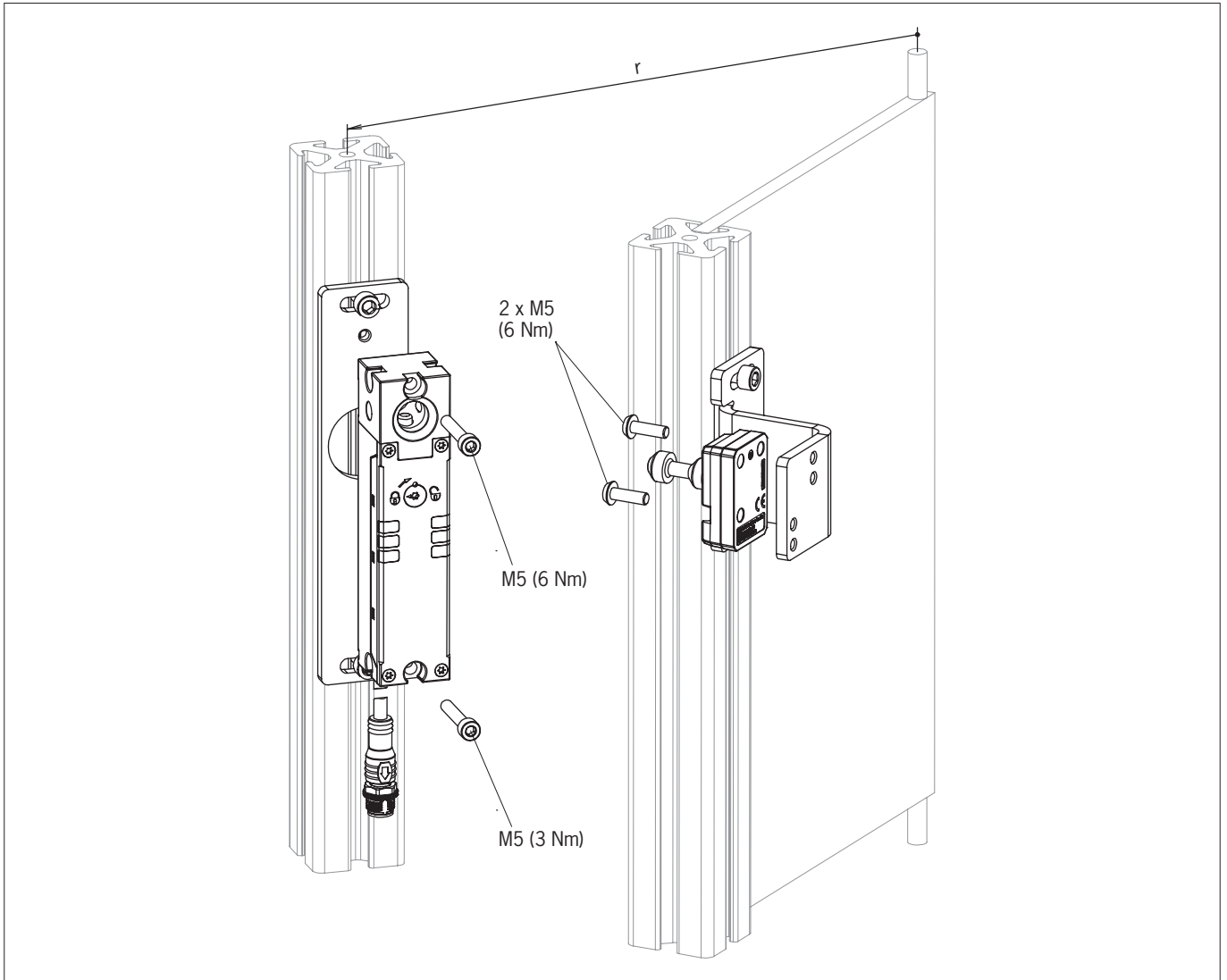

Fig. 3: Installation example

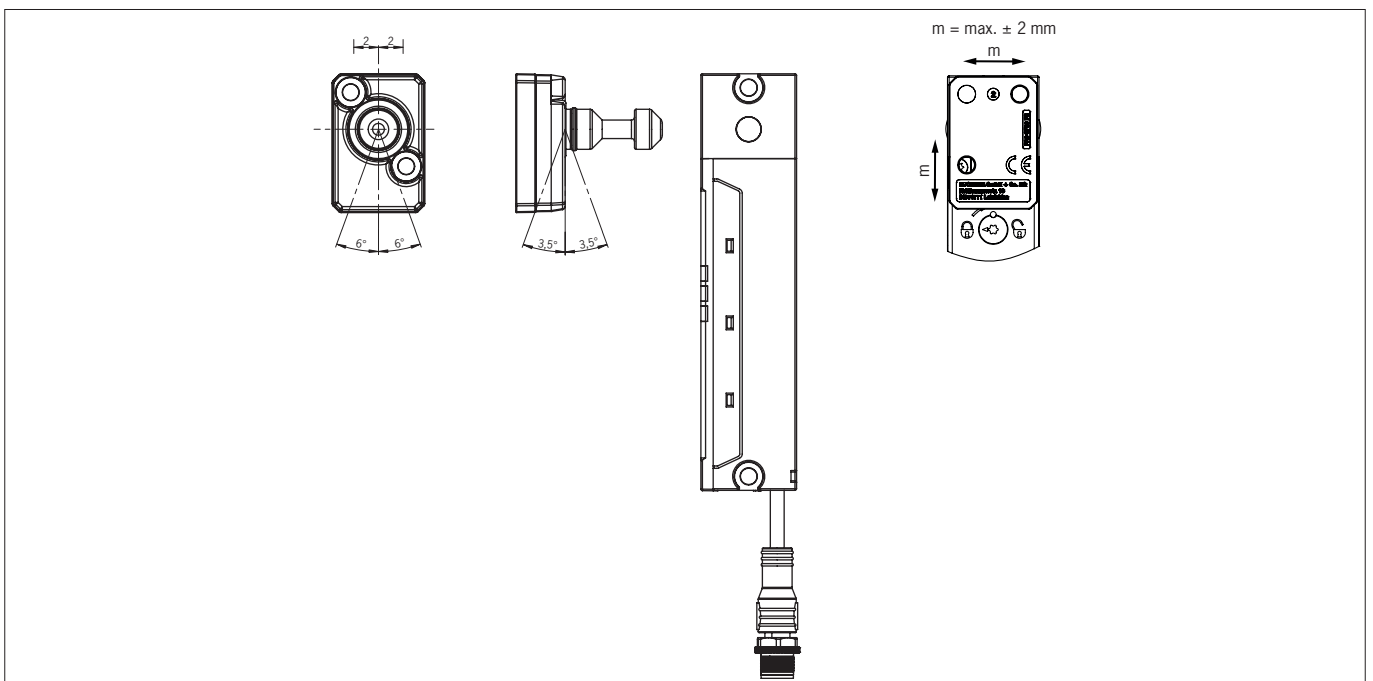

Fig. 4: Maximum actuator deflection and maximum center offset

9. Electrical connection

The following connection options are available:

- › Separate operation
- › Series connection with wiring in the control cabinet
- › Series connection with Y-distributors
- › Connection without IO-Link communication
- › Connection with IO-Link communication



WARNING

In the event of a fault, loss of the safety function due to incorrect connection.

- › To ensure safety, both safety outputs must always be evaluated.
- › Monitoring outputs must not be used as safety outputs.
- › Lay the connecting cables with protection to prevent short circuits.



CAUTION

Risk of damage to equipment or malfunctions as a result of incorrect connection.

- › Do not use a control system with pulsing or switch off the pulsing function in your control system. The device generates its own test pulses on the safety outputs. A downstream control system must tolerate these test pulses, which may have a length of up to 300 µs. Depending on the inertia of the downstream device (control system, relay, etc.), this can lead to short switching processes. The test pulses are output with the safety outputs switched off only during device start.
- › The inputs on a connected evaluation unit must be positive switching, as the two outputs on the safety switch deliver a level of +24 V in the switched-on state.
- › All the electrical connections must either be isolated from the mains supply by a safety transformer according to IEC 61558-2-6 with limited output voltage in the event of a fault, or by other equivalent insulation measures (SELV).
- › All electrical outputs must have an adequate protective circuit for inductive loads. The outputs must be protected with a free-wheeling diode for this purpose. Varistors and RC interference suppression units must not be used.
- › Power devices which are a powerful source of interference must be installed in a separate location away from the input and output circuits for signal processing. The cable routing for safety circuits should be as far away as possible from the cables of the power circuits.
- › To prevent EMC interference, the physical environmental and operating conditions at the installation site of the device must comply with the requirements according to the standard EN 60204-1 (EMC).
- › Pay attention to any interference fields from devices such as frequency converters or induction heating systems. Observe the EMC instructions in the manuals from the respective manufacturer.
- › If the solenoid is operated with a frequency of more than 0.2 Hz, the device may react with a delay.
- › In devices with IMP/IMM inputs, the power supply for the evaluation electronics is separate from the power supply for the guard locking solenoid.
If different power supplies are used, they must have the same reference potential.
- › For device variants with two connecting cables, both cables must be laid in the same cable duct.



Important!

If the device does not appear to function when the operating voltage is applied (e.g. STATE LED does not flash), the safety switch must be returned to EUCHNER.

9.1. Notes about



Important!

- › This device is intended to be used with a Class 2 power source in accordance with UL1310. As an alternative an LV/C (Limited Voltage/Current) power source with the following properties can be used:
This device shall be used with a suitable isolating source in conjunction with a fuse in accordance with UL248. The fuse shall be rated max. 3.3 A and be installed in the max. 30 V DC power supply to the device in order to limit the available current to comply with the UL requirements. Please note possibly lower connection ratings for your device (refer to the technical data).
- › For use and application as per the requirements of UL ¹⁾ a connecting cable listed under the UL category code CYJV/7, min. 24 AWG, min. 80 °C, must be used.

1) Notice on the scope of the UL approval: only for applications as per NFPA 79 (Industrial Machinery).

9.2. Safety in case of faults

- › The operating voltage at UB and the solenoid operating voltage at IMP are reverse polarity protected.
- › The safety outputs FO1A/FO1B are short circuit-proof.
- › A short circuit between the safety outputs is detected on starting or when the safety outputs are activated by the device.
- › A short circuit in the cable can be excluded by laying the cable with protection.

9.3. Fuse protection for power supply

The power supply must be provided with fuse protection depending on the number of switches and the current required for the outputs. The following rules apply:

Max. current consumption of an individual switch I_{\max}

$$I_{\max \text{ UB}} = I_{\text{UB}_1} + I_{\text{FO1A+FO1B}} + I_{\text{OX1}} + I_{\text{OX2}}$$

$$I_{\text{UB}_1} = \text{Switch operating current (max. 50 mA)}$$

$$I_{\text{OX}} = \text{Load current of monitoring output (max. 10 mA per monitoring output)}$$

$$I_{\text{FO1A+FO1B}} = \text{Load current of safety outputs FO1A + FO1B (2 x max. 75 mA)}$$

$$I_{\max \text{ IMP}} = \text{Solenoid operating current (max. 500 mA)}$$

Max. current consumption of a switch chain $\Sigma I_{\max \text{ UB}}$

$$\Sigma I_{\max \text{ UB}} = I_{\text{FO1A+FO1B}} + n \times (I_{\text{UB}_2} + I_{\text{OX1}} + I_{\text{OX2}})$$

$$n = \text{Number of connected switches}$$

$$I_{\text{UB}_2} = \text{Switch operating current (max. 80 mA)}$$



Important!

If there are further monitoring outputs, their load current must also be taken into account.

9.4. Requirements for connecting cables



CAUTION

Risk of damage to equipment or malfunctions as a result of incorrect connecting cables.

- › Use connection components and connecting cables from EUCHNER.
- › If other connection components are used, the requirements in the following table apply. EUCHNER provides no warranty for safe function in case of failure to comply with these requirements.

Observe the following requirements with respect to the connecting cables:

Parameter	Value		Unit
	2 x M12/8-pin or 5-pin	M12/8-pin	
Recommended cable type	LIYY 8 x 0.25 or 5 x 0.34	LIYY 8 x 0.34	mm ²
Cable	8 x 0.25 or 5 x 0.34	8 x 0.34	mm ²
Cable resistance R max.	80	80	Ω/km
Inductance L max.	0.65	0.65	mH/km
Capacitance C max.	120	120	nF/km

9.5. Connector assignment safety switch CTS-...-AB-... with plug connectors 2 x M12

Plug connector (view of connection side)	Pin	Designation	Function	Conductor coloring of connecting cable ¹⁾
<p>2 x M12</p>	X1.1	F11B	Enable input, channel B	WH
	X1.2	UB	Electronics operating voltage, 24 V DC	BN
	X1.3	F01A	Safety output, channel A Active monitoring of the guard locking for process protection: ON, if door is closed and locked. Optional monitoring of the guard locking for process protection: ON, if door is closed.	GN
	X1.4	F01B	Safety output, channel B Active monitoring of the guard locking for process protection: ON, if door is closed and locked. Optional monitoring of the guard locking for process protection: ON, if door is closed.	YE
	X1.5	OX1/C ²⁾	Monitoring output 1/communication	GY
	X1.6	F11A	Enable input, channel A	PK
	X1.7	OVUB	Electronics operating voltage, 0 V DC	BU
	X1.8	-	n.c.	RD
X2.1	IMM	Solenoid operating voltage, 0 V DC	BN	
X2.2	OX2 ²⁾	Monitoring output 2	WH	
X2.3	-	n.c.	BU	
X2.4	IMP	Solenoid operating voltage, 24 V DC	BK	
X2.5	-	n.c.	GY	

1) Only for standard EUCHNER connecting cable

2) The function of the monitoring output OX is determined by the actuator taught-in. You will find more detailed information in the data sheet 2153710 or at www.euchner.com.

9.6. Connector assignment safety switch CTS-...-SA-... with plug connector M12, 8-pin

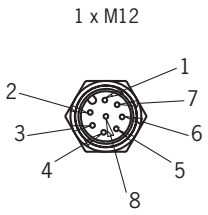
Plug connector (view of connection side)	Pin	Designation	Function	Conductor coloring of connecting cable ¹⁾
 <p>1 x M12</p>	1	IMP	Solenoid operating voltage, 24 V DC	WH
	2	UB	Electronics operating voltage, 24 V DC	BN
	3	F01A	Safety output, channel A Active monitoring of the guard locking for process protection: ON, if door is closed and locked. Optional monitoring of the guard locking for process protection: ON, if door is closed.	GN
	4	F01B	Safety output, channel B Active monitoring of the guard locking for process protection: ON, if door is closed and locked. Optional monitoring of the guard locking for process protection: ON, if door is closed.	YE
	5	OX1/C ²⁾	Monitoring output 1/communication	GY
	6	OX2 ²⁾	Monitoring output 2	PK
	7	OVUB	Electronics operating voltage, 0 V DC	BU
	8	IMM	Solenoid operating voltage, 0 V DC	RD

¹⁾ Only for standard EUCHNER connecting cable

²⁾ The function of the monitoring output OX is determined by the actuator taught-in. You will find more detailed information in the data sheet 2153710 or at www.euchner.com.

9.7. Notes on operation with safe control systems

Observe the following guidelines for connection to safe control systems:

- Use a common power supply for the control system and the connected safety switches.
- A pulsed power supply must not be used for UB. Tap the supply voltage directly from the power supply unit. If the power supply is connected to a terminal of a safe control system, this output must provide sufficient electrical current.
- The safety outputs F01A and F01B can be connected to the safe inputs of a control system. Prerequisite: the input must be suitable for pulsed safety signals (OSSD signals, e.g. from light grids). The control system must tolerate test pulses on the input signals. This normally can be set up by parameter assignment in the control system. Observe the notes of the control system manufacturer. For the test pulse duration of your safety switch, refer to chapter 16. *Technical data on page 37.*
- With series connection: always connect inputs F11A and F11B directly to a power supply unit or to outputs F01A and F01B of another EUCHNER BR device. Pulsed signals must not be present at inputs F11A and F11B.

A detailed example of connecting and setting the parameters of the control system is available for many devices at www.euchner.com, in the area *Downloads/Applications/CTS*. The features of the respective device are dealt with there in greater detail.

9.8. Connection without and with IO-Link communication

9.8.1. Connection without IO-Link communication

Only the safety and monitoring outputs are switched with this connection method.

With a series connection, the safety signals are looped through from device to device.

9.8.2. Connection with IO-Link communication

If, in addition to the safety function, detailed monitoring and diagnostic data are to be processed, a BR/IO-Link Gateway is required. To poll the communication data from the connected device, communication connection C is routed to the BR/IO-Link Gateway.

You will find further information in the operating instructions for your BR/IO-Link Gateway.

10. Connection of a single CTS-C2-BP/BR-FLX (separate operation)



WARNING

In the event of a fault, loss of the safety function due to incorrect connection.
 ▶ To ensure safety, both safety outputs FO1A and FO1B must always be evaluated.



Important!

The example shows only an excerpt that is relevant for the connection of the CTS system. The example illustrated here does not show complete system planning. The user is responsible for safe integration into the overall system. Detailed application examples can be found at www.euchner.com. Simply enter the order number of your switch in the search box. You will find all available connection examples for the device in *Downloads*.

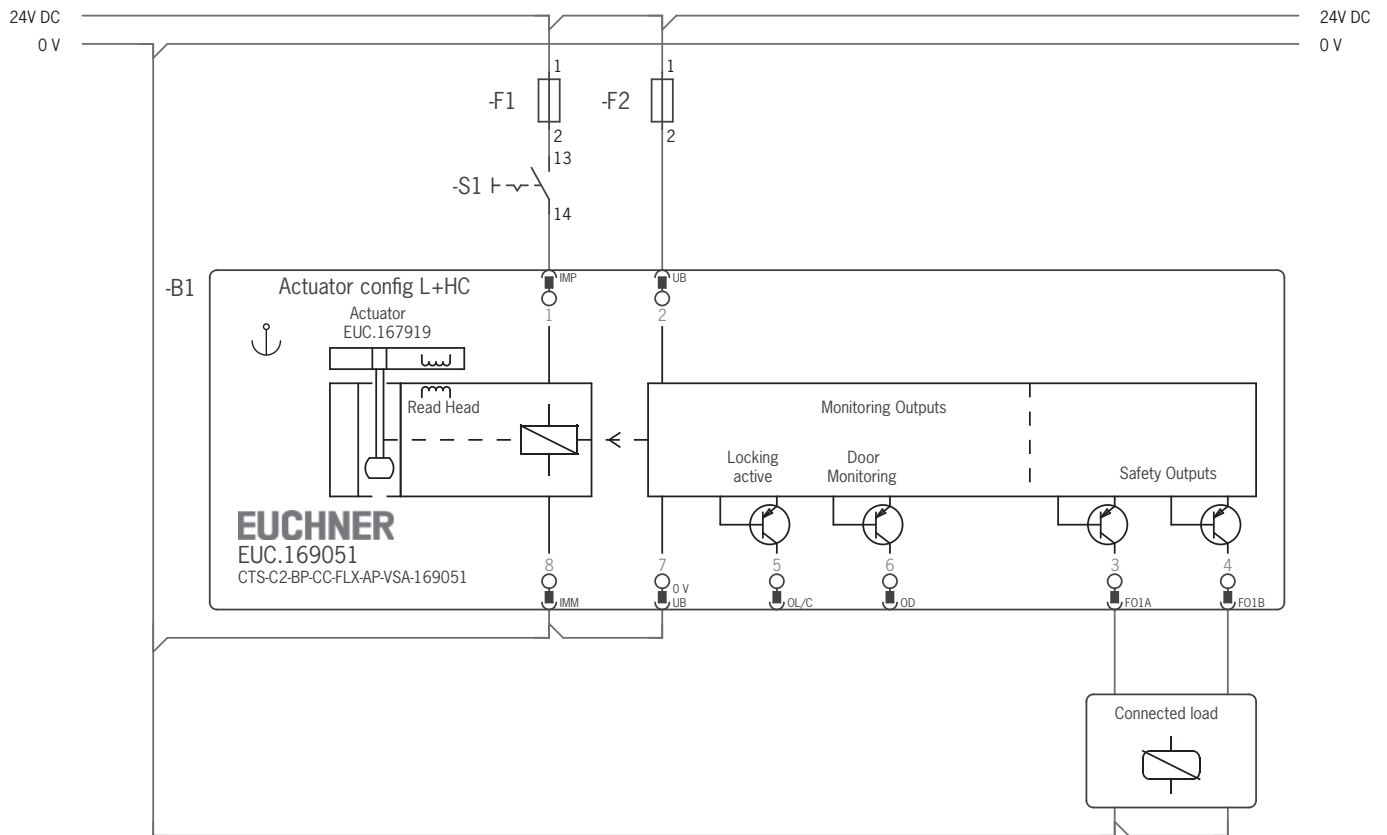

Fig. 5: Connection example for separate operation (principle of operation)

11. Connection of several devices in a chain (series connection)



WARNING

- In the event of a fault, loss of the safety function due to incorrect connection.
- › To ensure safety, both safety outputs FO1A and FO1B must always be evaluated.



Important!

- › A BR chain may contain a maximum of 20 safety switches.
- › The BR chain is not permitted to be changed during operation.
- › The example shows only an excerpt that is relevant for the connection of the CTS system. The example illustrated here does not show complete system planning. The user is responsible for safe integration into the overall system. Detailed application examples can be found at www.euchner.com. Simply enter the order number of your switch in the search box. You will find all available connection examples for the device in *Downloads*.
- › Make sure you use the correct Y-distributors. See chapter 11.2.3. *Connector assignment of Y-distributor for series connection without IO-Link communication on page 24* and chapter 11.2.4. *Connector assignment of Y-distributor for series connection with IO-Link communication on page 26*.

11.1. Series connection with wiring in the control cabinet

The series connection can be implemented via additional terminals in a control cabinet.



Important!

- In case of series connection with IO-Link communication:
- › The safety outputs are permanently assigned to the respective safety inputs of the downstream switch. FO1A must be routed to FI1A and FO1B to FI1B.
 - › If the connections are interchanged (e.g. FO1A to FI1B), the downstream device will enter the fault state.

11.2. Series connection with Y-distributors

The series connection is shown here based on the example of the version with plug connector M12. The switches are connected one behind the other with the aid of pre-assembled connecting cables and Y-distributors. If a safety door is opened or if a fault occurs on one of the switches, the system shuts down the machine.

11.2.1. Maximum cable lengths with BR switch chains



Important!

The maximum number of switches in a BR switch chain depends on many factors, including the cable length. This case example shows a standard application. You will find further connection examples at www.euchner.com.

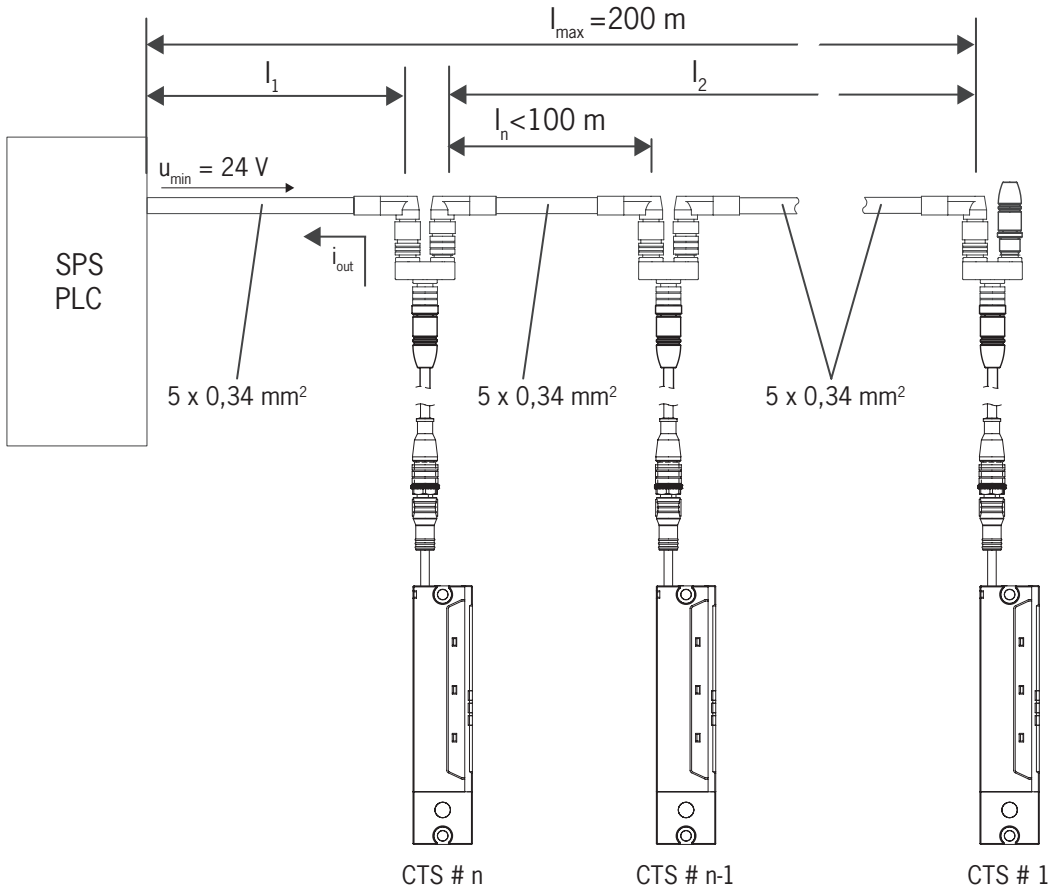

11.2.2. Determining cable lengths using the example table

n Max. number of switches depending on the cable length	I _{F01A/F01B} (mA) Possible output current per channel F01A/F01B	I ₁ (m) Max. cable length from the last switch to the control system
5	10	150
	25	100
	50	80
	75	50
6	10	120
	25	90
	50	70
	75	50
10	10	70
	25	60
	50	50
	75	40

11.2.3. Connector assignment of Y-distributor for series connection without IO-Link communication

(Only for BR version with plug connectors 2 x M12)



Important!

- › The switch chain must always be terminated with strapping plug 097645.
- › A higher-level control system cannot detect which safety door is open or on which switch a fault has occurred with this connection technology.

Plug connector X1		Y-distributor	Plug connector X2 / X3																																			
<table border="1"> <thead> <tr> <th colspan="2">X1</th> </tr> <tr> <th>Pin</th> <th>Function</th> </tr> </thead> <tbody> <tr> <td>X1.1</td> <td>FI1B</td> </tr> <tr> <td>X1.2</td> <td>UB</td> </tr> <tr> <td>X1.3</td> <td>F01A</td> </tr> <tr> <td>X1.4</td> <td>F01B</td> </tr> <tr> <td>X1.5</td> <td>n.c.</td> </tr> <tr> <td>X1.6</td> <td>FI1A</td> </tr> <tr> <td>X1.7</td> <td>OVUB</td> </tr> <tr> <td>X1.8</td> <td>*</td> </tr> </tbody> </table>		X1		Pin	Function	X1.1	FI1B	X1.2	UB	X1.3	F01A	X1.4	F01B	X1.5	n.c.	X1.6	FI1A	X1.7	OVUB	X1.8	*	<p>097627</p>	<p>X2 Plug</p> <p>X3 Socket</p> <table border="1"> <thead> <tr> <th colspan="2">X2</th> </tr> <tr> <th>Pin</th> <th>Function</th> </tr> </thead> <tbody> <tr> <td>X2.1</td> <td>UB</td> </tr> <tr> <td>X2.2</td> <td>F01A</td> </tr> <tr> <td>X2.3</td> <td>0 V</td> </tr> <tr> <td>X2.4</td> <td>F01B</td> </tr> <tr> <td>X2.5</td> <td>*</td> </tr> </tbody> </table>		X2		Pin	Function	X2.1	UB	X2.2	F01A	X2.3	0 V	X2.4	F01B	X2.5	*
X1																																						
Pin	Function																																					
X1.1	FI1B																																					
X1.2	UB																																					
X1.3	F01A																																					
X1.4	F01B																																					
X1.5	n.c.																																					
X1.6	FI1A																																					
X1.7	OVUB																																					
X1.8	*																																					
X2																																						
Pin	Function																																					
X2.1	UB																																					
X2.2	F01A																																					
X2.3	0 V																																					
X2.4	F01B																																					
X2.5	*																																					
<p>X1 Socket</p>		<p>111696 112395</p> <p>With connecting cable</p>	<p>X2 Plug</p> <p>X3 Socket</p> <table border="1"> <thead> <tr> <th colspan="2">X3</th> </tr> <tr> <th>Pin</th> <th>Function</th> </tr> </thead> <tbody> <tr> <td>X3.1</td> <td>UB</td> </tr> <tr> <td>X3.2</td> <td>FI1A</td> </tr> <tr> <td>X3.3</td> <td>0 V</td> </tr> <tr> <td>X3.4</td> <td>FI1B</td> </tr> <tr> <td>X3.5</td> <td>*</td> </tr> </tbody> </table>		X3		Pin	Function	X3.1	UB	X3.2	FI1A	X3.3	0 V	X3.4	FI1B	X3.5	*																				
X3																																						
Pin	Function																																					
X3.1	UB																																					
X3.2	FI1A																																					
X3.3	0 V																																					
X3.4	FI1B																																					
X3.5	*																																					

* Function and compatibility are dependent on the connector assignment of the device connected.

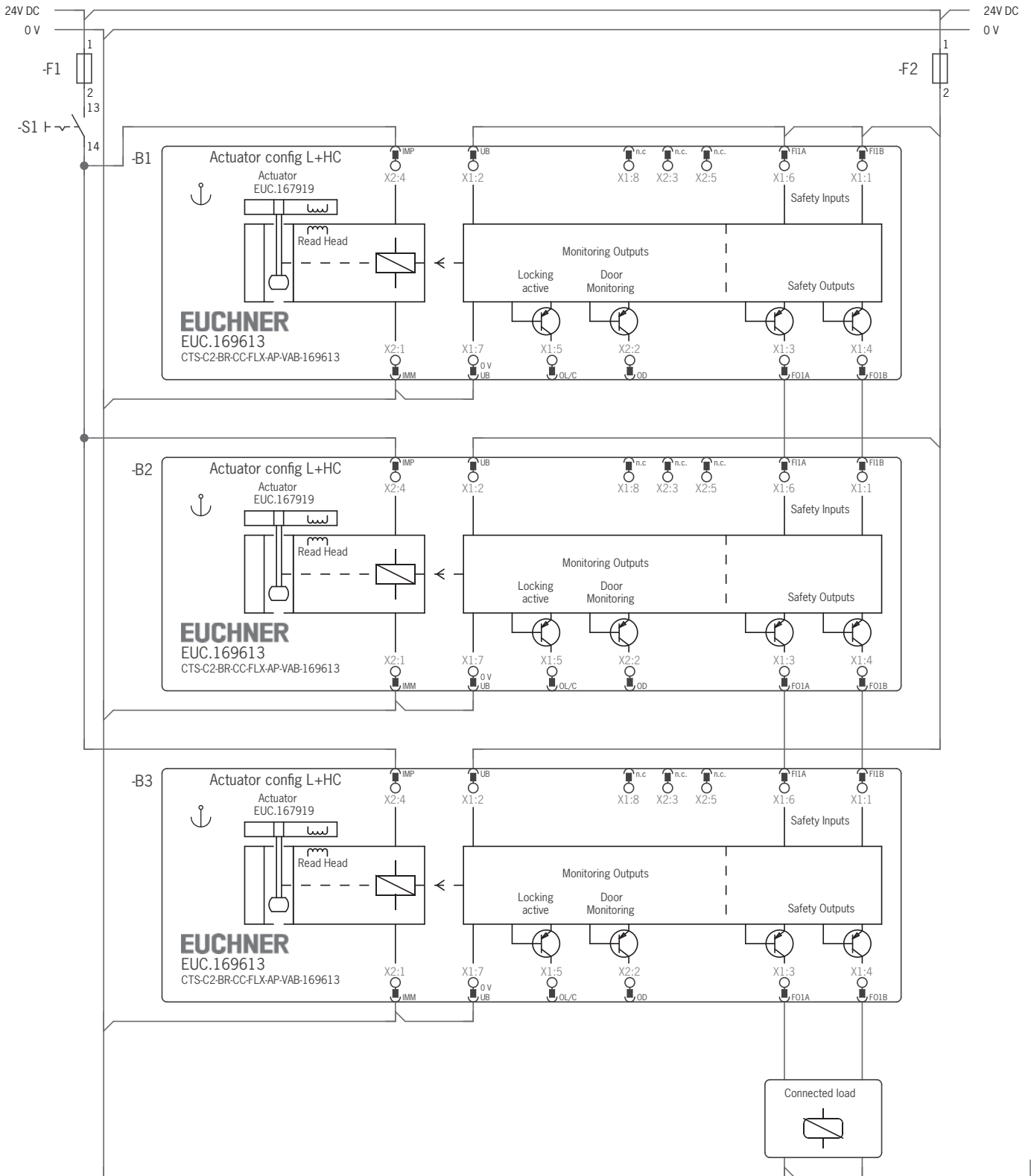

Fig. 6: Connection example for series connection (principle of operation)

11.2.4. Connector assignment of Y-distributor for series connection with IO-Link communication

(Only for BR version with plug connectors 2 x M12)



Important!

› The switch chain must always be terminated with strapping plug 097645.

Plug connector X1		Y-distributor	Plug connector X2/X3																																		
<table border="1"> <thead> <tr> <th colspan="2">X1</th> </tr> <tr> <th>Pin</th> <th>Function</th> </tr> </thead> <tbody> <tr> <td>X1.1</td> <td>F11B</td> </tr> <tr> <td>X1.2</td> <td>UB</td> </tr> <tr> <td>X1.3</td> <td>F01A</td> </tr> <tr> <td>X1.4</td> <td>F01B</td> </tr> <tr> <td>X1.5</td> <td>C</td> </tr> <tr> <td>X1.6</td> <td>F11A</td> </tr> <tr> <td>X1.7</td> <td>0VUB</td> </tr> <tr> <td>X1.8</td> <td>n.c.</td> </tr> </tbody> </table>		X1		Pin	Function	X1.1	F11B	X1.2	UB	X1.3	F01A	X1.4	F01B	X1.5	C	X1.6	F11A	X1.7	0VUB	X1.8	n.c.	<p>157913</p>	<p>X2 Plug</p> <p>X3 Socket</p> <table border="1"> <thead> <tr> <th colspan="2">X2</th> </tr> <tr> <th>Pin</th> <th>Function</th> </tr> </thead> <tbody> <tr> <td>X2.1</td> <td>UB</td> </tr> <tr> <td>X2.2</td> <td>F01A</td> </tr> <tr> <td>X2.3</td> <td>0 V</td> </tr> <tr> <td>X2.4</td> <td>F01B</td> </tr> <tr> <td>X2.5</td> <td>C</td> </tr> </tbody> </table>	X2		Pin	Function	X2.1	UB	X2.2	F01A	X2.3	0 V	X2.4	F01B	X2.5	C
X1																																					
Pin	Function																																				
X1.1	F11B																																				
X1.2	UB																																				
X1.3	F01A																																				
X1.4	F01B																																				
X1.5	C																																				
X1.6	F11A																																				
X1.7	0VUB																																				
X1.8	n.c.																																				
X2																																					
Pin	Function																																				
X2.1	UB																																				
X2.2	F01A																																				
X2.3	0 V																																				
X2.4	F01B																																				
X2.5	C																																				
<p>X1 Socket</p>		<p>158192 158193</p> <p>With connecting cable</p>	<p>X2 Plug</p> <p>X3 Socket</p> <table border="1"> <thead> <tr> <th colspan="2">X3</th> </tr> <tr> <th>Pin</th> <th>Function</th> </tr> </thead> <tbody> <tr> <td>X3.1</td> <td>UB</td> </tr> <tr> <td>X3.2</td> <td>F11A</td> </tr> <tr> <td>X3.3</td> <td>0 V</td> </tr> <tr> <td>X3.4</td> <td>F11B</td> </tr> <tr> <td>X3.5</td> <td>C</td> </tr> </tbody> </table>	X3		Pin	Function	X3.1	UB	X3.2	F11A	X3.3	0 V	X3.4	F11B	X3.5	C																				
X3																																					
Pin	Function																																				
X3.1	UB																																				
X3.2	F11A																																				
X3.3	0 V																																				
X3.4	F11B																																				
X3.5	C																																				

12. Using communication data

A BR/IO-Link Gateway is required to use the device's communication data and forward them to a higher-level bus system. The following devices are suitable:

- › GWY-CB-1-BR-IO (BR/IO-Link Gateway)
- › ESM-CB (safety relay with integrated BR/IO-Link Gateway)

12.1. Connection to a BR/IO-Link Gateway GWY-CB

The Gateway is an IO-Link device. Communication via IO-Link offers cyclical (process data) and acyclical (device data and events) data exchange (see chapter 12.3. *Overview of the communication data on page 28*).

The communication connection C on the device allows the diagnostic line to be connected to the Gateway. The Ox/C connection represents a non-safety-related communication channel between the Gateway and the connected devices.

IO-Link communication can be used for the following functions as well:

- › Reset for acknowledging error messages

You will find further information in the operating instructions for your BR/IO-Link Gateway.

12.2. Connection to a safety relay ESM-CB

The safety relay ESM-CB features an integrated BR/IO-Link Gateway. In addition to functioning as an IO-Link device (see chapter 12.1. *Connection to a BR/IO-Link Gateway GWY-CB on page 27*), the device can be used for connecting two monitored single- or dual-channel sensor circuits. The sensor circuits evaluate various signaling devices:

- › Sensor circuit S1 with short circuit detection; suitable for single- or dual-channel safety sensors
- › Sensor circuit S2, suitable for OSSD signals; short circuit detection by signaling device

When at least one sensor circuit is interrupted, the safety relay initiates the safe state. Different relay starting behaviors and various monitoring functions are possible.

The device's safety outputs F01A and F01B are routed to the OSSD inputs of the safety relay. The Ox/C connection of the device allows the diagnostic line to be connected to the Gateway.

You will find further information in the operating instructions for your safety relay with integrated BR/IO-Link Gateway.

12.3. Overview of the communication data

The switch transmits both process data that are continuously transmitted to the evaluation unit (cyclical data) and data that can be polled specifically as needed (acyclical data). For further information on connection and on the communication data, refer to the operating instructions for your BR/IO-Link Gateway.

12.3.1. Cyclical data (process data)

Table 2: Cyclical data (process data)

	Bit 7	Bit 6	Bit 5	Bit 4	Bit 3	Bit 2	Bit 1	Bit 0
Byte 1	OI	-	OER	-	OM	-	-	OD
Byte 2	-	-	-	-	OLS	-	OL	OT

Bit	Signal	Message
OI	Diagnostics	There is a fault, see chapter 15.3. <i>Error messages on page 35.</i>
OM	Status	The safety outputs of the device are switched.
OD	Door position 1	A valid actuator is detected in the actuating range, and the guard is closed.
OER	Escape release	The device has been unlocked manually.
OT	Door position 2	The actuator is inserted in the switch head and the guard locking can be activated.
OLS	Locking element	The locking element is stuck, see chapter 15.3. <i>Error messages on page 35.</i>
OL	Guard locking	Guard locking is active.

12.3.2. Acyclical data (device data and events)

After one of the commands listed below is sent, the requested data are provided via the IO-Link Gateway. The reply message always consists of 8 bytes in big endian format.

Example 1: reply message in response to the command *Send device ID number/serial number*: 06 **02 8F ED 00 01 17 00**

In this example, the device's ID number is **167917** and its serial number is **279**.

Byte number	Byte 0	Byte 1	Byte 2	Byte 3	Byte 4	Byte 5	Byte 6	Byte 7
Reply in hex	06	02	8F	ED	00	01	17	00
Description	User data length in bytes	Device ID number			Serial number			Padding data
Reply in dec	6 bytes	167917			279			-

Example 2: reply message for the command *Send current device configuration*: 02 **01 07** 00 00 00 00 00

In this example, the device has the **high** coding level and guard lock monitoring is **active**.

Byte number	Byte 0	Byte 1	Byte 2	Byte 3	Byte 4	Byte 5	Byte 6	Byte 7
Reply in hex	02	01	07	00	00	00	00	00
Description	User data length in bytes	Coding level	Guard lock monitoring	Padding data				
Reply in dec	2 bytes	High coding level	Active	-	-	-	-	-

Command		Reply		
HEX	Meaning	Number of bytes	Bit sequences (big endian format)	
0x02	Send device ID number/serial number	6	Bytes 1 - 3	Device ID number
			Bytes 4 - 6	Serial number
0x03	Send version number of the device	5	Byte 1	{V}
			Bytes 2 - 4	Version number
0x05	Send number of devices in series connection	1		
0x08	Send number of starting processes	3		
0x11	Send number of switching cycles (solenoid)	3		
0x12	Send current error code	1		
0x13	Send most recently saved error code	1		
0x14	Send size of log file	1		
0x15	Send entry from log file with index	1		
0x16	Send current actuator code	5	Bytes 3 - 5	
0x17	Send taught-in actuator code	5	Bytes 3 - 5	
0x18	Send disabled actuator code	5	Bytes 3 - 5	
0x19	Send applied voltage in mV	2		
0x0B	Send current device configuration	2	Byte 1	0x00 – Coding level not configured
				0x01 – High coding level
				0x02 – Low coding level
		Byte 2	0x00 – Guard lock monitoring not configured	
			0x05 – Guard lock monitoring optional	
0x08 – Guard lock monitoring active				
0x0F	Send number of teach-in operations, factory resets and resets for acknowledging error messages	3	Byte 1	Number of teach-in operations
			Byte 2	Number of factory resets
			Byte 3	Number of resets for acknowledging error messages
0x1A	Send current temperature in °C	1		
0x1B	Send number of switching cycles	3		
0x1D	Reset for acknowledging error messages ¹⁾	-		
0x1E	Factory reset	1	0x1E – Factory reset performed	

1) Each BR device must be addressed individually in a chain.





For more information on these and other acyclical data, refer to the operating instructions for your BR/IO-Link Gateway.

13. Setup

13.1. Configuring device and teaching-in actuator for the first time

The device must be configured and the actuator must be allocated to the safety switch before the system forms a functional unit. During configuration, with the aid of a function actuator, the monitoring of the guard locking for process protection is specified as permanently active or available as an additional option. The coding level is also defined. As such, the selection of the actuator determines the function of the device.

Configuration and the teach-in operation occur simultaneously in the delivery state or after a factory reset.

Actuator	Monitoring of the guard locking for process protection	Coding level
A-FLX-D-OC-167919 	Active	High coding level
A-FLX-D-OD-169044 	Optional	High coding level
A-FLX-D-OE-169045 	Active	Low coding level
A-FLX-D-OF-169046 	Optional	Low coding level



WARNING

Danger to life due to improper use

- › During the initial configuration or reconfiguration after a factory reset, ensure that all risk assessment measures for the selected function are performed.



Important!

- › If the actuator to be taught-in is in the actuating range for less than 30 s, the device will not be configured and the actuator will not be taught-in.

Prerequisite:

- › The device is in the delivery state. A factory reset must be performed before a preconfigured device can be reconfigured (see chapter 14. *Factory reset on page 33*).
- › The device is isolated from the operating voltage.

1. Apply operating voltage.

- ➔ The STATE LED flashes white quickly. The device carries out a self-test.
- ➔ The STATE LED flashes white slowly. The device is in unlimited teach-in standby.

2. Insert an actuator.

- ➔ The teach-in operation begins. The STATE LED flashes alternately white/violet slowly.
- ➔ The teach-in operation ends after approx. 30 s. The STATE LED flashes alternately green/blue quickly (approx. 3 Hz).

3. Switch off operating voltage for at least 3 s.

- ➔ The code of the actuator taught-in is activated in the safety switch. The actuator is valid.

4. Switch on operating voltage.

- ➔ The device operates normally.

13.2. Teaching-in new actuator (only for evaluation of the actuator with a high coding level)



Tip!

Prior to switching on the operating voltage, close the guard on which the actuator to be taught-in is installed. The teach-in operation starts immediately after switching on. This feature simplifies above all teach-in with series connections and on large installations.



Important!

- › During a teach-in operation, the safety outputs are switched off, i.e. the system is in the safe state.
- › The safety switch disables the code of the preceding device if teach-in is carried out for a new actuator. Teach-in is not possible again immediately for this device if a new teach-in operation is carried out. The disabled code is enabled again in the safety switch only after a third code has been taught-in.
- › The safety switch can be operated only with the last actuator taught-in.
- › The number of teach-in operations is unlimited.
- › If the actuator to be taught-in is in the actuating range for less than 30 s, it will not be activated and the most recently taught-in actuator will remain saved. The device indicates an error (see chapter 15.3. Error messages on page 35).

Prerequisite:

- › The device is isolated from the operating voltage.
1. Make sure there is no actuator in the actuating range.
 2. Apply operating voltage.
 - ➔ The STATE LED flashes white quickly (5 Hz). The device carries out a self-test.
 - ➔ The device is in teach-in standby for up to 3 minutes. The STATE LED illuminates white.
 4. Insert an actuator that has not been taught-in.
 - ➔ The teach-in operation begins. The STATE LED flashes alternately white/violet slowly.
 - ➔ The teach-in operation ends after approx. 30 s. The STATE LED flashes alternately green/blue quickly (approx. 3 Hz).
 5. Switch off operating voltage for at least 3 s.
 - ➔ The code of the new actuator taught-in is activated in the safety switch. The actuator is valid.
 6. Switch on operating voltage.
 - ➔ The device operates normally.

13.3. Functional check



WARNING

- Danger of fatal injury as a result of faults in installation and the functional check.
- › Before carrying out the functional check, make sure that there are no persons in the danger area.
 - › Observe the valid accident prevention regulations.

13.3.1. Mechanical function test

The actuator must slide easily into the switch. Close the guard several times to check the function.

13.3.2. Electrical function test

After installation and after any fault, the safety function must be fully checked. Proceed as follows:



If monitoring of the guard locking for process protection is active:

1. Switch on operating voltage.
 - ➔ The machine must not start automatically.
 - ➔ The safety switch carries out a self-test.
 2. Close all guards. Activate guard locking.
 - ➔ The machine must not start automatically. It must not be possible to open the guard.
 - ➔ The STATE LED illuminates green, the LOCK LED illuminates orange.
 3. Enable operation in the control system.
 - ➔ It must not be possible to release guard locking as long as operation is enabled.
 4. Unlock guard locking if necessary and open guard.
 - ➔ The machine must switch off and it must not be possible to start it as long as the guard is open.
- Repeat steps 2 - 4 for each guard.



If monitoring of the guard locking for process protection is optional:

1. Switch on operating voltage.
 - ➔ The machine must not start automatically.
 - ➔ The safety switch carries out a self-test.
 2. Close all guards. As soon as the actuator is inserted into the switch, the safety outputs are switched on independent of the state of the guard locking.
 - ➔ The machine must not start automatically.
 - ➔ The STATE LED illuminates green. In addition, depending on the state of the guard locking, the LOCK LED illuminates orange permanently or with a short interruption.
 3. Enable operation in the control system.
 4. Unlock guard locking if necessary and open guard.
 - ➔ The machine must switch off and it must not be possible to start it as long as the guard is open.
- Repeat steps 2 - 4 for each guard.
- Check every safety guard to ensure that deactivating the guard locking will not affect the safety function.

14. Factory reset

A factory reset deletes the configuration and restores the device's factory settings.

To perform a factory reset, connect the two outputs FO1A and FO1B to 0 V before connecting the operating voltage or send the command 0x1E via IO-Link communication (see chapter 12.3.2. *Acyclical data (device data and events)* on page 28).

15. Status and error messages

15.1. LED displays

LED	Color
STATE	RGB
LOCK	orange
DIA	red

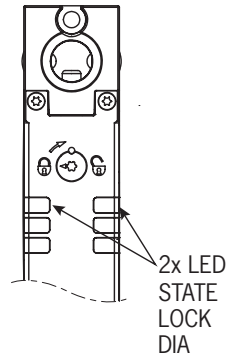

































Important!





















If you do not find the displayed device status in the following tables, this indicates an internal device fault. Contact the EUCHNER support team.









Key to symbols	○		LED not illuminated
			LED illuminated
			LED flashes quickly (3 Hz)
			LED flashes slowly (0.6 Hz)
			LED flashes alternately
	X		Any state

15.2. Status messages

Operating mode	LED indicator		Safety outputs F01A/F01B	Guard locking signal OL	Door position 1 signal OD	Status
	STATE RGB	LOCK orange				
Self-test	 white quickly 3 Hz (CTS-BP: 2 s; CTS-BR: 5 s)	○	off	off	off	Self-test after operating voltage is switched on.
	 green quickly					No communication with the BR/IO-Link Gateway.
Normal operation	 green		on	on	on	 If guard lock monitoring is active: door is closed and locked. The safety outputs of the preceding device in a series connection are switched on.
	 green	 slowly	on	off	on	 If guard lock monitoring is optional: door is closed. The safety outputs of the preceding device in a series connection are switched on.
	 green slowly	 slowly	off	off	on	 Door is closed and not locked. The safety outputs of the preceding device in a series connection are switched off.
	 green slowly	○	off	off	off	Door is open.
	 green slowly	 quickly	off	off	off	Door is open and ready for locking.
	 ↔  white/orange slowly	 slowly	X	off	X	 Guard locking was manually released. The safety outputs are switched off.  Guard locking was manually released. The safety outputs are switched on as long as the actuator is in the switch.
	 ↔  green/red quickly	 quickly	X	on	on	Actuator was not inserted fully. The locking element is stuck.
	 ↔  green/orange slowly	X	off	X	X	The predecessor in the series connection is not switched on.
Teach-in operation	 white			off	X	Device is in teach-in standby (see chapter 13.2. <i>Teaching-in new actuator (only for evaluation of the actuator with a high coding level) on page 31</i>).
	 white slowly			X	X	Device is not configured (see chapter 13.1. <i>Configuring device and teaching-in actuator for the first time on page 30</i>)
	 ↔  white/violet slowly	○	off		off	Teach-in operation. Door is closed.
	 ↔  green/blue quickly			X	X	Positive acknowledgment after successful teach-in operation.
Factory reset	 ↔  white/blue quickly	○	off	off	off	Factory reset
Error	depending on the error	depending on the error	off	depending on the error		Error message (see chapter 15.3. <i>Error messages on page 35</i>).

15.3. Error messages

Error code via IO-Link	LED indicator			Error	Troubleshooting	Ac-knowl-edging errors		
	STATE RGB	LOCK orange	DIA red			Open/close door	Reset	
Teach-in errors								
0x1F	   white/red slowly			Actuator removed from the actuating range prior to the end of the teach-in operation.	Check whether the actuator is outside the actuating range or in the limit range.		●	
0x25	 blue quickly	○		Disabled actuator detected during the teach-in operation: The actuator was taught-in during the penultimate teach-in operation and is disabled for the current teach-in operation.	Repeat the teach-in operation with a new actuator (see chapter 13.2. <i>Teaching-in new actuator (only for evaluation of the actuator with a high coding level) on page 31</i>).		●	
0x42	 blue slowly			Invalid actuator detected: The actuator is not intended for the current device configuration.	<ul style="list-style-type: none"> Perform the teach-in operation with an actuator intended for the current device configuration. If the device is to be reconfigured, observe chapter 13.1. <i>Configuring device and teaching-in actuator for the first time on page 30</i>. 		●	
0x45	 blue			Faulty or incompatible actuator detected: The actuator's data structure cannot be read. The actuator is faulty or is not suitable for the device.	Repeat teach-in operation with new actuator.		●	
Input errors								
0x2E	 violet slowly	○		Different signal states at the safety inputs F1A and F1B during operation.	<ul style="list-style-type: none"> Check wiring. Check preceding device in the switch chain. 		●	
0x30				Different signal states at the safety inputs F1A and F1B during the self-test.			●	
0x31 0x32				Test pulses not detected at safety input F1A or F1B during operation.			●	
0x36 0x37				Test pulses not detected at safety input F1A or F1B during the self-test.			●	
Transponder/read errors								
0x44	 blue slowly	○		Invalid actuator detected during operation: The actuator is not intended for the current device configuration.	Use a valid actuator.		●	
0x46	 blue			Faulty or incompatible actuator detected during operation: The actuator's data structure cannot be read. The actuator is faulty or is not suitable for the device.			●	
0x47	 blue quickly			Disabled actuator detected during operation: The actuator is not the currently valid actuator.			●	
0x48	   white/blue slowly			Actuator not taught-in detected during operation.		<ul style="list-style-type: none"> Use the currently valid actuator. Teach-in actuator. 		●
0x89	   blue/red quickly			X			Possibly mechanically damaged actuator detected during operation.	<ul style="list-style-type: none"> Check actuator for any damage. Replace actuator if necessary. Check whether the actuator is outside the actuating range or in the limit range.

Error code via IO-Link	LED indicator			Error	Troubleshooting	Ac-knowledging errors	
	STATE RGB	LOCK orange	DIA red			Open/close door	Reset
Output errors							
0x54		○	 	A HIGH signal is detected at safety output FO1A or FO1B during the self-test. The voltage level at safety outputs FO1A and FO1B during operation does not meet the requirements. External voltage might be present.	Check wiring.		●
Environment errors							
0x60 0x61 0x62 0x63		○	 	Supply voltage or device temperature too high. Supply voltage or device temperature too low. Supply voltage or device temperature too high. Supply voltage or device temperature too low.	<ul style="list-style-type: none"> Observe the specified supply voltage (see chapter 16. <i>Technical data on page 37</i>) Observe the specified temperature range (see chapter 16. <i>Technical data on page 37</i>). Check system configuration: cable length, number of devices in the switch chain. 		● ● ● ●
Internal error							
0x01		○		Internal device error	Restart the device. On repeated occurrence, contact the EUCHNER support team.		●
-	○	○					

15.4. Acknowledging error messages

If the DIA LED flashes inversely once, the error message can be acknowledged by opening and closing the guard. If the error is still displayed afterward, a reset must be performed.

If the DIA LED is permanently illuminated, the error message can be acknowledged only by a reset.

The reset can be performed as follows.

Reset	Centrally for all devices a chain	Each device must be addressed individually	Further information
By briefly disconnecting the power supply (at least 3 s)	●	-	-
Via the cyclical data of IO-Link communication	●	-	See operating instructions for the IO-Link Gateway
Via the acyclical data of IO-Link communication	-	●	See chapter 12.3.2. <i>Acyclical data (device data and events) on page 28</i>

Reset for acknowledging error messages does not delete the configuration.

	<p>Important!</p> <p>Contact the EUCHNER support team if the fault display is not reset after briefly disconnecting the power supply.</p>
---	--

16. Technical data



NOTICE

If a data sheet is available for the product, the information on the data sheet applies.

16.1. Technical data for safety switch CTS-C2-BP/BR-FLX

Parameter	Value			Unit
	min.	typ.	max.	
General				
Material				
- Switch head cover	Die-cast zinc			
- Safety switch housing	Reinforced thermoplastic			
Installation position	Any			
Degree of protection	IP65/IP67/IP69/IP69K			
Safety class acc. to EN IEC 61140	III			
Degree of contamination (external, acc. to EN IEC 60947-1)	3			
Mechanical life	1 x 10 ⁶ operating cycles			
Ambient temperature	-20	-	+50	°C
Approach speed	-	-	20	m/min
Actuating force	25			N
Extraction force	25			N
Retention force	10			N
Locking force F _{max}	3900			N
Locking force F _{Zh}	3000			N
Weight	0.34			kg
Connection (depending on version)	- Connecting cable PVC, 0.14 mm ² , with 2 plug connectors M12, 5- and 8-pin - Connecting cable PVC, 0.14 mm ² with plug connector M12, 8-pin - Connecting cable PVC with flying lead, 8 x 0.14 mm ²			
Operating voltage U _B (reverse polarity protected, regulated, residual ripple < 5%)	24 V DC -15% / +20% (SELV)			V DC
Current consumption I _{UB}	50			mA
The following applies to the approval acc. to UL	Operation only with UL Class 2 power supply or equivalent measures			
Switching load acc. to UL	DC 24 V, class 2			
External fuse (operating voltage U _B)	1	-	8	A
External fuse (solenoid operating voltage U _{IMP})	1	-	8	A
Rated insulation voltage U _i	32			V
Rated impulse withstand voltage U _{imp}	0.8			kV
Rated conditional short-circuit current	100			A
Shock and vibration resistance	Acc. to EN 60947-5-3			
EMC protection requirements	Acc. to EN 60947-5-3			
Ready delay				
- CTS...BP	-	-	1	s
- CTS...BR	-	-	5	s
Risk time acc. to EN 60947-5-3	-	-	200	ms
Risk time acc. to EN 60947-5-3, extension for each additional device	10			ms
Turn-on time	-	-	400	ms
Discrepancy time	-	-	10	ms
Test pulse duration	-	-	0.3	ms
Test pulse interval	96	-	-	ms

Parameter	Value			Unit
	min.	typ.	max.	
Safety outputs F01A/F01B	Semiconductor outputs, p-switching, short circuit-proof			
Output voltage U_{F01A}/U_{F01B} ¹⁾				
- HIGH U_{F01A}/U_{F01B}	$U_B - 4$	-	U_B	V DC
- LOW U_{F01A}/U_{F01B}	0	-	1	
Output current	1	-	75	mA
Utilization category	DC-13 24 V 75 mA Caution: outputs must be protected with a free-wheeling diode in case of inductive loads			
Switching frequency	-	-	0.2	Hz
Monitoring outputs O_x/C	p-switching, short circuit-proof			
Output voltage	$0.8 \times U_B$	-	U_B	V DC
Output current	1	-	10	mA
Solenoid				
Solenoid operating voltage (reverse polarity protected, regulated, residual ripple < 5%)	24 V DC -15% / +20% (SELV)			V DC
Solenoid current consumption I_{MP}	500			mA
Connection rating	9			W
Solenoid duty cycle	100			%
Characteristics acc. to EN ISO 13849-1 and EN IEC 62061	Monitoring of the guard position			
Category	4			
Performance Level (PL)	e			
PFH_D	$6.44 \times 10^{-9}/h$			
Maximum SIL	3			
Mission time	20			years

1) Values at a switching current of 50 mA without taking into account the cable lengths

16.1.1. Typical system times

Refer to the technical data for the exact values.

Ready delay:

After switching on, the device carries out a self-test. The system is ready for operation only after this time.

Turn-on time of safety outputs:

The max. reaction time t_{on} is the time from the moment when the guard is locked to the moment when the safety outputs switch on.

Risk time according to EN 60947-5-3:

The risk time is the maximum time until at least one of the safety outputs FO1A or FO1B switches off safely when the actuator is removed from the actuating range. This also applies if an internal or external fault occurs at this moment.

The following applies to guard lock monitoring for process protection: if an actuator moves outside the actuating range, the safety outputs FO1A and FO1B are switched off after the risk time at the latest.

If several devices are operated in a series connection, the risk time of the overall device chain will increase with each device added. Use the following calculation formula:

$$t_r = t_{r,e} + (n \times t_i)$$

t_r = Total risk time

$t_{r,e}$ = Risk time for single device (see technical data)

t_i = Risk time extension per device

n = Number of additional devices (total number -1)

Discrepancy time:

The safety outputs FO1A and FO1B switch with a slight time offset. They have the same signal state no later than after the discrepancy time.

Test pulses at the safety outputs:

The device generates its own test pulses on the safety outputs FO1A and FO1B. A downstream control system must tolerate these test pulses.

This can usually be set up in the control systems by parameter assignment. If parameter assignment is not possible for your control system or if shorter test pulses are required, contact our support organization.

The test pulses are output only if the safety outputs are switched on.

16.2. Radio frequency approvals

FCC ID: 2AJ58-18

IC: 22052-18

FCC/IC-Requirements

This device complies with part 15 of the FCC Rules and with Industry Canada's licence-exempt RSSs. Operation is subject to the following two conditions:

- 1) This device may not cause harmful interference, and
- 2) this device must accept any interference received, including interference that may cause undesired operation.

Changes or modifications not expressly approved by the party responsible for compliance could void the user's authority to operate the equipment.

NOTE: This equipment has been tested and found to comply with the limits for a Class A digital device, pursuant to part 15 of the FCC Rules. These limits are designed to provide reasonable protection against harmful interference when the equipment is operated in a commercial environment. This equipment generates, uses, and can radiate radio frequency energy and, if not installed and used in accordance with the instruction manual, may cause harmful interference to radio communications.

Operation of this equipment in a residential area is likely to cause harmful interference in which case the user will be required to correct the interference at his own expense.

Le présent appareil est conforme aux CNR d'Industrie Canada applicables aux appareils radio exempts de licence. L'exploitation est autorisée aux deux conditions suivantes :

- (1) l'appareil ne doit pas produire de brouillage, et
- (2) l'utilisateur de l'appareil doit accepter tout brouillage radioélectrique subi, même si le brouillage est susceptible d'en compromettre le fonctionnement.

Supplier's Declaration of Conformity

47 CFR § 2.1077 Compliance Information

Unique Identifier:

CTS-C1-BP Series

CTS-C1-BR Series

CTS-C2-BP Series

CTS-C2-BR Series

Responsible Party – U.S. Contact Information

EUCHNER USA Inc.

1860 Jarvis Avenue

Elk Grove Village, Illinois 60007

+1 315 701-0315

info(at)euchner-usa.com

http://www.euchner-usa.com

16.3. Dimension drawing for safety switch CTS

Necessary minimum travel + perm. overtravel

Approach direction	Standard actuator
Horizontal (h)	27 + 4

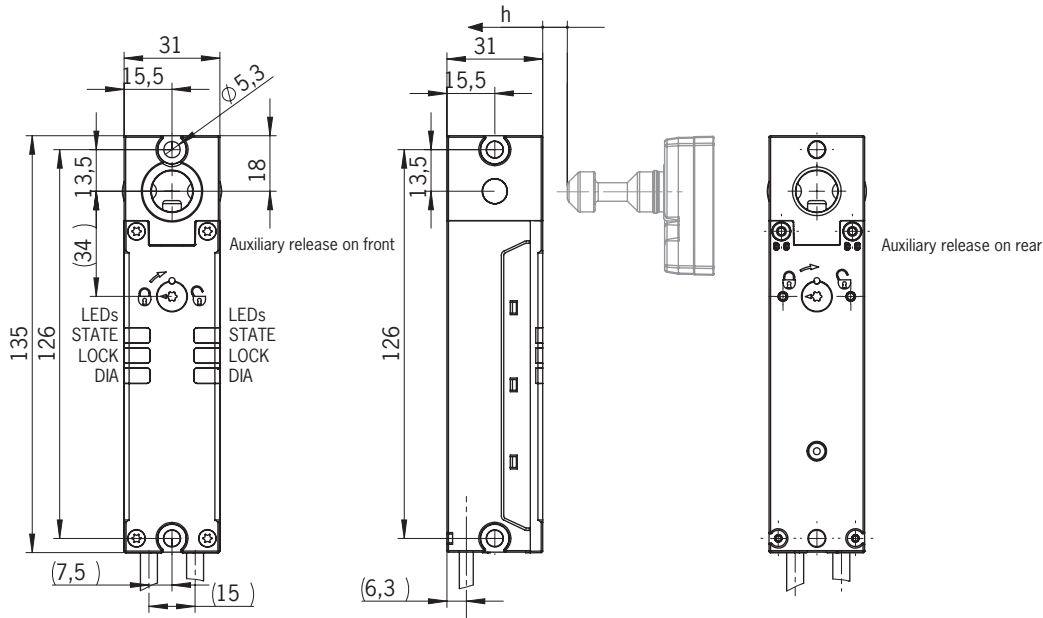

With escape release

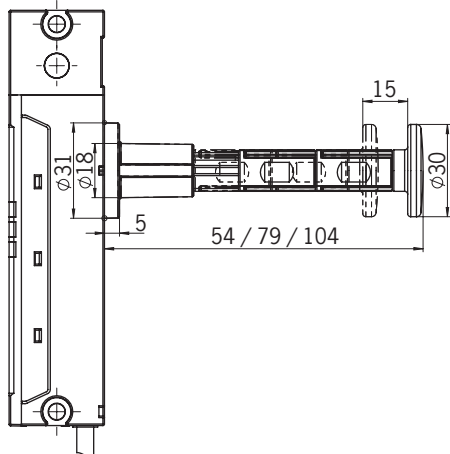

NOTICE

- › The actuator shaft for the escape release can be extended using extension pieces.
- › If extension pieces are used, the guide sleeve supplied must be used.

16.4. Technical data for actuator A-FLX-D-0-...

Parameter	Value			Unit
	min.	typ.	max.	
Material	Safety screws, galvanized steel 8.8			
- Mounting	NBR			
- Cover	Stainless steel			
- Actuating element	Fiber reinforced plastic, black			
- Housing				
Weight	0.06			kg
Ambient temperature	-20	-	+55	°C
Degree of protection	IP65/IP67/IP69/IP69K			
Mechanical life	1 x 10 ⁶			
Locking force, max.	3900			N
Locking force F _{Zh}	3000			N
Installation position	Any			
Overtravel	4			mm
Power supply	Inductive via read head			

16.4.1. Dimension drawing for actuator A-FLX-D-0-...

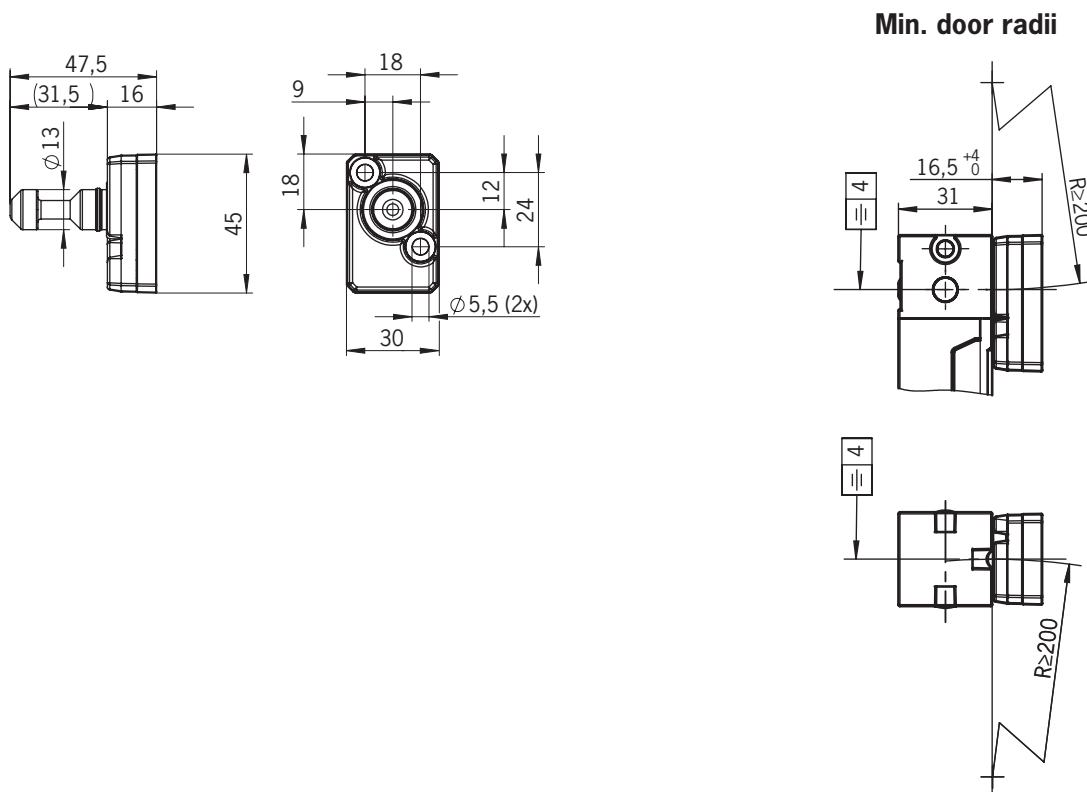

17. Ordering information and accessories



Tip!

Suitable accessories, e.g. cables or assembly material, can be found at www.euchner.com. To order, enter the order number of your item in the search box and open the item view. Accessories that can be combined with the item are listed in *Accessories*.

18. Inspection and service



WARNING

Danger of severe injuries due to the loss of the safety function.

- › If damage or wear is found, the complete switch and actuator assembly must be replaced. Replacement of individual parts or assemblies is not permitted.
- › Check the device for proper function at regular intervals and after every fault. For information about possible time intervals, refer to EN ISO 14119:2013, section 8.2.

Regular inspection of the following is necessary to ensure trouble-free long-term operation:

- › Check the switching function (see chapter 13.3. *Functional check on page 32*)
- › Check all additional functions (e.g., escape release, lockout bar, etc.)
- › Check the secure mounting of the devices and the connections
- › Check for contamination

No servicing is required. Repairs to the device are only allowed to be made by EUCHNER.



NOTICE

The year of manufacture is given in the laser marking at the bottom right corner. The current version number in the format (V X.X.X) can also be found on the device.

19. Service

If servicing is required, please contact:

EUCHNER GmbH + Co. KG
Kohlhammerstraße 16
70771 Leinfelden-Echterdingen
Germany

Service telephone:

+49 711 7597-500

E-mail:

support@euchner.de

Internet:

www.euchner.com

20. Declaration of conformity

The EU declaration of conformity can be found at www.euchner.com. Enter the order number of your device in the search box. The document is available under *Downloads*.

EUCHNER GmbH + Co. KG
Kohlhammerstraße 16
70771 Leinfelden-Echterdingen
Germany
info@euchner.de
www.euchner.com

Edition:
MAN20001531-04-12/23
Title:
Operating Instructions Transponder-Coded Safety Switch
CTS-C2-BP/BR-FLX
(translation of the original operating instructions)
Copyright:
© EUCHNER GmbH + Co. KG, 12/2023

Subject to technical modifications; no responsibility is accepted for the accuracy of this information.